

Installation and User Guide for

MULTICAL[®] 602 &

ULTRAFLOW[®] 34

Cooling meter



Kamstrup

www.kamstrup.com

MID designations

Permissible operating conditions / measuring ranges:

Calculator	θ : 2 °C...50 °C	$\Delta\theta$: 3 K...40 K
Temperature sensor pair	θ : 2 °C...50 °C	$\Delta\theta$: 3 K...30 K
Flow sensor	θ : 2 °C...50 °C	

Mechanical environment:

M1 (fixed installation with minimum vibration).

Electromagnetic environment:

E1 and E2 (housing/light industry and industry). The meter's signal cables must be drawn at min. 25 cm distance to other installations.

Climatic environment:

The installation of MULTICAL® shall be made in non-condensing environments and in closed location (indoor). The ambient temperature must be within 5...55 °C.

Maintenance and repair:

The energy supplier can replace communication module, battery and temperature sensor pair. The flow sensor is verified separately and can, therefore, be separated from the calculator.

Other repairs require subsequent reverification in an accredited laboratory.

MULTICAL® 602, type 602-B/C/D must be connected to a temperature sensor pair type Pt500.

MULTICAL® 602, type 602-A must be connected to a temperature sensor pair type Pt100.

MULTICAL® 602, type 602-A/B/C can be connected to flow sensor type ULTRAFLOW®, electronic pick-up, or flow sensors with reed switch output.

MULTICAL® 602, type 602-D must be connected to a flow sensor with 24 V active pulse output.

Irrespective of flow sensor type, "pulses/litre" must be identical in flow sensor and calculator.

Battery for replacement:

Kamstrup type 66-00-200-100.

MULTICAL® 602 & ULTRAFLOW® 34

English

INSTALLATION



Kamstrup

Kamstrup A/S
Industrivej 28, Stilling, DK-8660 Skanderborg
Tel: +45 89 93 10 00 · Fax: +45 89 93 10 01
info@kamstrup.com · www.kamstrup.com

Contents

General information	3	<i>Type 67-0A: 2 pulse outputs for CE and CV + hourly data logger + scheduler</i>	14
Mounting of temperature sensors	3	<i>Type 67-0B: 2 pulse outputs for CE and CV + prog. data logger</i>	14
Pocket sensor pair	3		
Short direct temperature sensor pair	4	<i>Type 602-0C: 2 pulse outputs for CE and CV</i>	15
Mounting of flow sensor	4	Base modules	15
Mounting ULTRAFLOW®	5	<i>Data + pulse inputs, type 67-00-10</i>	15
<i>Humidity and condensation</i>	6	<i>M-Bus, type 67-00-20/27/28/29</i>	16
Mounting of calculator	6	<i>Radio + pulse inputs, 67-00-21/25/26</i>	16
In cooling applications	6	<i>Prog. data logger + RTC + 4...20 mA inputs + pulse inputs, type 67-00-22</i>	16
<i>Separate/wall mounting</i>	6	<i>Analog outputs, type 67-00-23</i>	16
<i>Panel mounting</i>	7	<i>Lon Works, type 67-00-24</i>	16
Installation in applications with medium temperature less than 5 °C under ambient temperature	7	<i>Wireless M-Bus, type 602-00-30/602-00-35</i>	17
Electrical connection, MULTICAL® and ULTRAFLOW®	7	<i>ZigBee® + pulse inputs, type 67-00-60</i>	17
Connection example	8	<i>Metasys N2 + pulse inputs, type 67-00-62</i>	17
Heat meter with two flow sensors	8	<i>SIOX module (Auto detect Baud rate), type 602-00-64</i>	17
Electrical connection of Pulse Transmitter	9	<i>BACnet®, type 67-00-66</i>	17
Voltage supply of calculator/ Pulse Transmitter	10	<i>GSM/GPRS module (GSM6H), type 602-00-80</i>	18
Battery supply	10	<i>3G module (GSM8H 3G), type 602-00-81</i>	18
Mains modules	10	<i>Ethernet/IP module (IP201), type 602-00-82</i>	18
<i>High-power supply modules</i>	10	<i>High-Power RadioRouter + 2 pulse inputs (VA, VB), type 602-00-84</i>	18
<i>Isolated linear supply modules</i>	11	Module overview	19
Testing of function	11	Setup via front keys	20
Information codes "INFO"	12		
Plug-in modules	13		
Top modules	13		
<i>Type 67-02: ΔEnergy calculation and hourly data logger</i>	13		
<i>Type 67-03: PQ-limiter + hourly data logger</i>	13		
<i>Type 67-05: Data output + hourly data logger</i>	13		
<i>Type 67-07: M-Bus</i>	14		
<i>Type 67-09: ΔVolume calculation and hourly data logger</i>	14		

1. General information

⚠ Read this guide before installing the meter.

Kamstrup's guarantee obligations do not apply in case of incorrect mounting.

Please note that the following installation conditions must be obeyed:

- Pressure stage ULTRAFLOW®: PN16/PN25, see marking. Flow sensor marking does not apply to enclosed accessories.
- Pressure stage Kamstrup sensor pair type DS: PN16
- Pressure stage Kamstrup stainless steel pockets: PN25

At medium temperatures more than 5 °C below ambient temperature we recommend wall mounting of MULTICAL® 602

2. Mounting of temperature sensors

The temperature sensors used to measure flow and return temperatures respectively are a matched sensor pair that must never be separated.

Temperature sensors are usually mounted in MULTICAL® 602 from the factory. According to EN 1434 or OIML R75 the cable length must not be changed. If necessary, sensors must always be replaced in pairs.

The sensor marked with a red sign is installed in the flow pipe (cold pipe). The other sensor marked with a blue sign is installed in the return pipe (warm pipe).

Note: The sensor cables must not be pulled. Be aware of this in case of binding the cables.

2.1 Pocket sensor pair

Preferably, sensor pockets must be mounted in tee-pieces or in 45° lateral Y-pieces. The tip of the sensor pocket should be placed in the middle of the water flow.

Temperature sensors must be mounted from below.

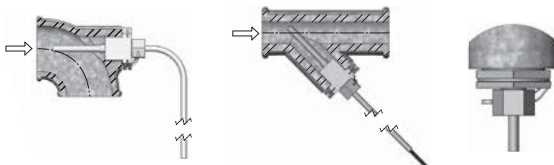

The temperature sensors should reach the bottom of the pockets. If a short response time is required, "non-hardening" heat conducting paste can be used.

Push the plastic sleeve on the sensor cable into the sensor pocket and secure the cable by means of the enclosed M4 sealing screw. Fasten the screw with your fingers only. Seal the pockets using seal and locking wire.

2.2 Short direct temperature sensor pair

The short direct sensors can be mounted in special ball valves or in special tee-pipes, both with threads up to R1 and built-in M10 union for the short direct sensor.

For mounting in existing cooling installations with standard angle tees Kamstrup A/S can, furthermore, supply R $\frac{1}{2}$ and R $\frac{3}{4}$ brass nipples fitting the short direct sensors.

The short direct sensor can also be fitted directly into all Kamstrup's ULTRAFLOW® variants with G $\frac{3}{4}$ and G1 thread on the meter case. Fasten the sensors' brass unions lightly (approx. 4 Nm) using a 12 mm face wrench and seal the sensors with seal and locking wire.

Temperature sensors must be mounted from below.

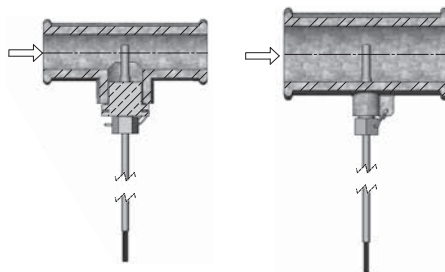

3. Mounting of flow sensor

Prior to installation of the flow sensor, the system should be flushed and protection plugs/plastic diaphragms removed from the flow sensor.

Correct flow sensor position (flow or return) appears from the front label of MULTICAL® 602. The flow direction is indicated by an arrow on the side of the flow sensor.

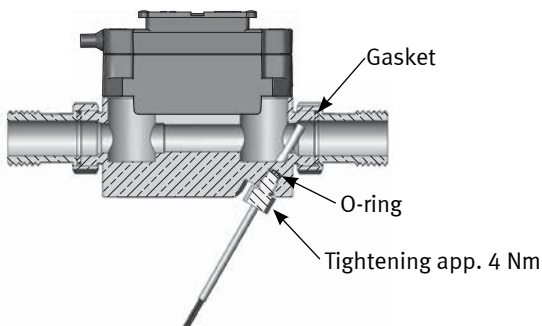

Glands and gaskets are mounted as shown in the above drawing.

Straight inlet: ULTRAFLOW® requires neither straight inlet nor straight outlet to meet the Measuring Instruments Directive (MID) 2004/22/ EC, OIML R75:2002 and EN 1434:2007. A straight inlet section will only be necessary in case of heavy flow disturbances before the sensor. We recommend to follow the guidelines of CEN CR 13582.

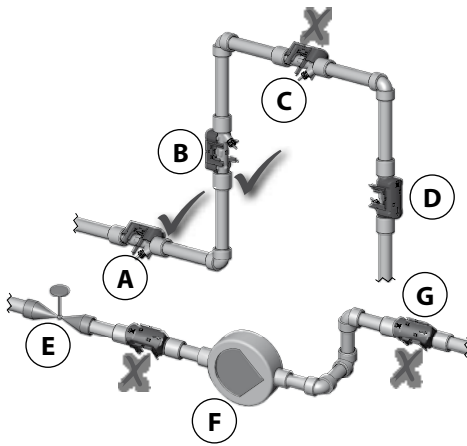

- A** Recommended flow sensor position
- B** Recommended flow sensor position
- C** Unacceptable position due to risk of air build-up
- D** Acceptable in closed systems. Unacceptable position in open systems due to risk of air build-up in the system
- E** A flow sensor ought not to be placed immediately after a valve, with the exception of block valves (ball valve type) which must be fully open when not used for blocking
- F** A flow sensor should not be placed at the suction side of a pump
- G** A flow sensor ought not to be placed after a double bend in two levels

In order to prevent cavitation the back pressure at ULTRAFLOW® must be min. 1.5 bar at q_p and min. 2.5 bar at q_s . This applies to temperatures up to approx. 80 °C. ULTRAFLOW® must not be exposed to lower pressure than the ambient pressure (vacuum).

3.1 Mounting ULTRAFLOW®

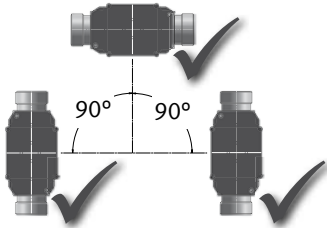

ULTRAFLOW® can be mounted vertically, horizontally or at an angle.

The electronics/plastic box must be placed on the side (at horizontal mounting).



ULTRAFLOW® may be turned up to +45° around the pipe axis.



ULTRAFLOW® must not be mounted with the plastic case pointing upwards or downwards.

3.1.1 Humidity and condensation

If there is risk of condensation, e.g. in cooling systems, or if ULTRAFLOW® is installed in moist environments, ULTRAFLOW® must be turned 45° around the pipe axis as shown in the drawing below.

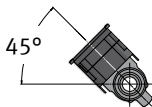

4. Mounting of calculator

4.1 In cooling applications

In applications with medium temperature more than 5 °C under the ambient temperature the MULTICAL® 602 calculator can be mounted in two different ways:

4.1.1 Separate/wall mounting

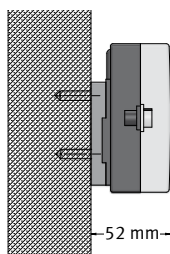

In connection with mounting in condensing environments as well as in order to prolong the battery lifetime, we recommend the use of a wall fitting.

The wall fitting makes it possible to mount MULTICAL® 602 directly on an even wall. Use the fitting as a template to mark and drill two 6 mm holes in the wall.

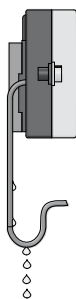

Front, vertical

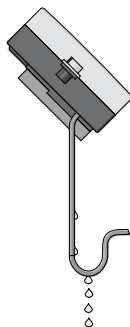

Front, at an angle
between horizontal
and vertical

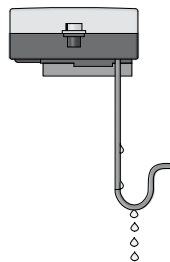

Front, horizontal

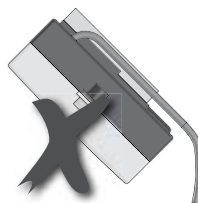

Note! Cables **must** be installed from below.

4.1.2 Panel mounting

MULTICAL® 602 can be mounted directly in panels and control panels, via Kamstrup's panel mounting kit, No. 66-99-104 (192 x 144 mm).

4.2 Installation in applications with medium temperature less than 5 °C under ambient temperature

In applications, with medium temperature less than 5 °C under ambient temperature, the calculator can also be mounted directly on the flow part. *See examples below.*

Threaded meter with MULTICAL® mounted on ULTRAFLOW®.

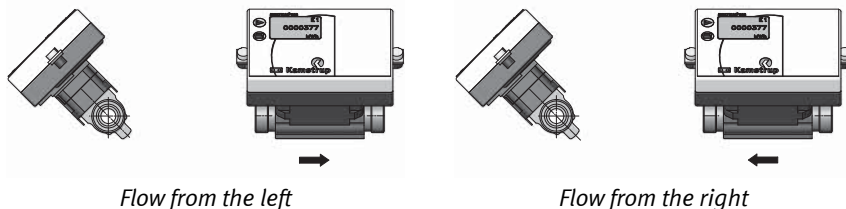

Flange meter with MULTICAL® mounted on ULTRAFLOW®.

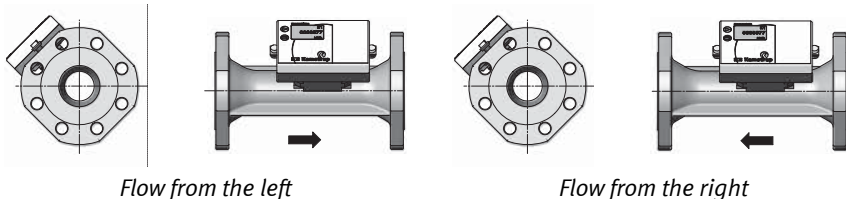

5. Electrical connection, MULTICAL® and ULTRAFLOW®

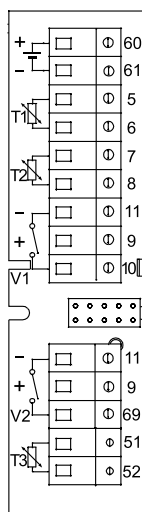

The polarity of temperature sensors T1, T2 and T3 is unimportant. For flow sensors V1 and V2 the below-mentioned colours are used when connecting ULTRAFLOW® and electronic pick-up units.

Flow sensors with reed switch output are connected to terminals 11–10 and 11–69 respectively.

	V1	V2	ULTRAFLOW®
-	11	11	Blue
+	9	9	Red
SIG	10	69	Yellow

	Terminal no.	Standard heat and cooling measurement	Heat measurement and leak surveillance	Energy measurement in open systems
T1	5-6	Sensor in flow (red)	Sensor in flow (red)	Sensor in flow (red)
T2	7-8	Sensor in return (blue)	Sensor in return (blue)	Sensor in return (blue)
V1	11-9-10	Flow sensor in flow or return	Flow sensor in flow	Flow sensor in flow
V2	11-9-69	-	Flow sensor in return	Flow sensor in return
T3	51-52	-	Tank/exchanger temp., if any	Reference sensor (grey)

5.1 Connection example

Examples of connection of ULTRAFLOW® and MULTICAL® (battery supplied).

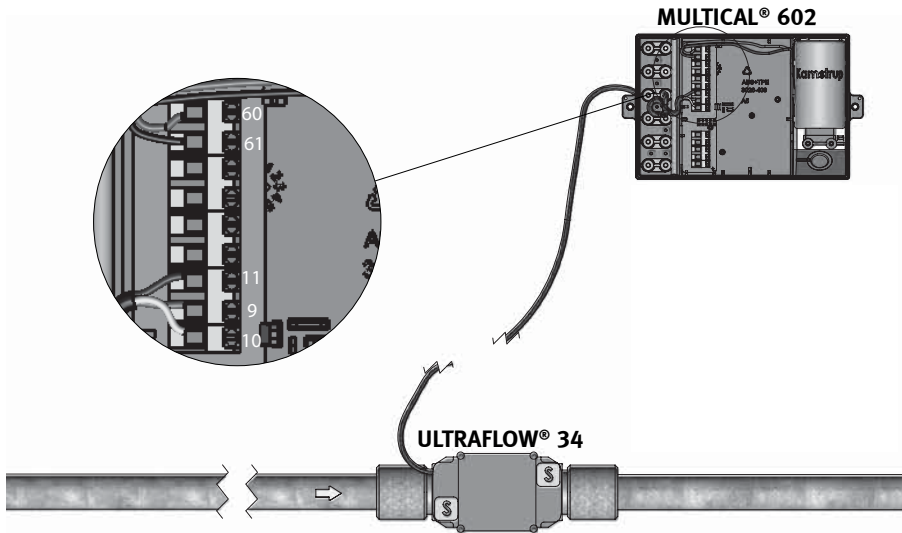

5.2 Heat meter with two flow sensors

MULTICAL® 602 can be used in various applications with two flow sensors, including leak surveillance and open systems. When two ULTRAFLOW® are direct connected to one MULTICAL® 602, a close electric coupling between the two pipes ought to be carried out as a main rule. If the two pipes are installed in a heat exchanger close to the flow sensors, however, the heat exchanger will provide the necessary electric coupling.

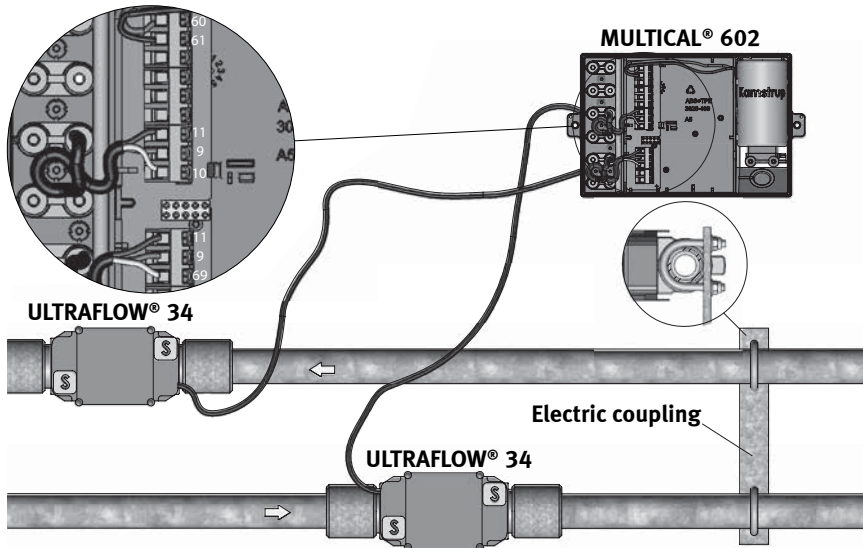

- Forward and return pipes are closely electrically coupled
- No welded joints occur

In installations where the electric coupling is not possible or welding in the pipe system can occur, the cable from one ULTRAFLOW® must go through a Pulse Transmitter with galvanic separation before the cable enters MULTICAL® 602.

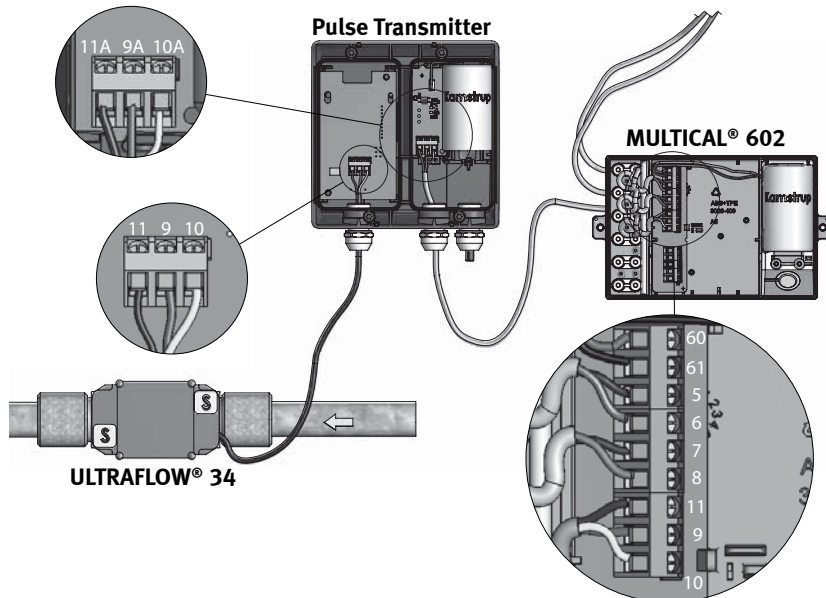

- Forward and return pipes are not necessarily closely coupled
- Electric welding *) can occur

*) Electric welding must always be carried out with the earth pole closest to the welding point. Damage to meters due to welding is **not** comprised by our factory guarantee.

5.3 Electrical connection of Pulse Transmitter

If ULTRAFLOW® 54 is used for other equipment, connection must be made through a Pulse Transmitter. See installation instructions No. 5512-1421 for further information.

6. Voltage supply of calculator/Pulse Transmitter

MULTICAL® 602 can be powered by a built-in lithium battery or an integral 24 VAC or 230 VAC mains module.

The two cables from battery or mains module are mounted in the calculator's terminal strip, no. 60 and 61.

⚠ The polarity must be correct: red wire to terminal no. 60 (+) and black wire to terminal no. 61 (-).

For Pulse Transmitter the supply module/battery is connected via a two-pole plug. See installation instructions No. 5512-1421 for further information.

6.1 Battery supply

MULTICAL® 602 is connected to a lithium battery, D-cell. The battery is marked with installation year, e.g. 2013, as well as production date.

Optimal battery lifetime is obtained by keeping the battery temperature below 30 °C, e.g. by wall mounting.

The voltage of a lithium battery is almost constant throughout the lifetime of the battery (approx. 3.65 V). Therefore, it is not possible to determine the remaining capacity of the battery by measuring the voltage.

The battery cannot and must not be charged and must not be short-circuited. Used batteries must be handed in for approved destruction, e.g. at Kamstrup A/S.

6.2 Mains modules

The modules are protection class II. They are connected by means of a two-wire cable (without earth) through the cable bush of the calculator placed in the right side of the connecting base. Use connecting cable with 5-10 mm outer diameter and ensure correct dismantling as well as correct mounting of cable relief.

Max. permitted fuse: 6 A

National regulations for electric installations must be observed.

6.2.1 High-power supply modules

These modules are galvanically separated from the mains supply. The modules include a Switch Mode Power Supply (SMPS), which fulfils double-isolation requirements when the calculator top is mounted. The modules are available in two variants with either 24 VAC or 230 VAC connection.

6.2.2 Isolated linear supply modules

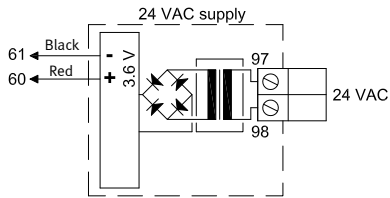

24 VAC

For instance 230/24 V transformer, type 66-99-403, can be used.

Note! MULTICAL® 602 cannot be powered by 24 VDC.

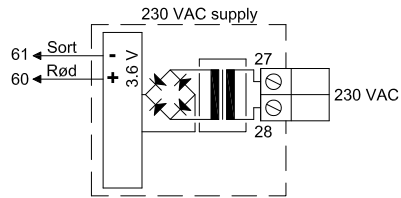

230 VAC

This module is used in connection with direct mains connection.

Note! External supply must be connected to the supply module.

7. Testing of function

Carry out an operational check when the energy meter has been fully mounted. Open thermoregulators and valves to establish water flow through the heating system. Activate the top key of MULTICAL® 602 and check that the displayed values for temperatures and water flow are credible values.

Important notice for the installation:

When the installation has been completed and there is volume flow in the system, it is necessary to activate the upper front button until the info code is displayed, and then wait for 10-20 seconds for the error status of the connected flow sensor(s) to be updated.

If this is omitted, the status of the connected flow meter(s) cannot be (remotely) read until the day after the meter was installed (i.e. after 00:00:10 meter time).

8. Information codes "INFO"

MULTICAL® 602 constantly monitors a number of important functions. In case of a serious error in measuring system or installation, "INFO" is displayed and an info-code can be read by activating the top front key until the measuring unit says "INFO". The info code is only displayed when the error is present.

Info code	Description	Response time
0	No irregularities	-
1	Supply voltage has been interrupted	-
8	Temperature sensor T1 outside measuring range	1...10 min.
4	Temperature sensor T2 outside measuring range	1...10 min.
32	Temperature sensor T3 outside measuring range	1...10 min.
64	Leak in cold water system	24 hours
256	Leak in heating system	24 hours
512	Burst in heating system	120 s.
ULTRAFLOW® info (must be activated CCC=4XX)		
16	Flow sensor V1, communication error	After one day (at 00:00)
1024	Flow sensor V2, communication error	After one day (at 00:00)
2048	Flow sensor V1, wrong pulse figure	After one day (at 00:00)
128	Flow sensor V2, wrong pulse figure	After one day (at 00:00)
4096	Flow sensor V1, signal too weak (air)	After one day (at 00:00)
8192	Flow sensor V2, signal too weak (air)	After one day (at 00:00)
16384	Flow sensor V1, wrong flow direction	After one day (at 00:00)
32768	Flow sensor V2, wrong flow direction	After one day (at 00:00)

If a number of info codes appear at a time, the sum of info codes is displayed. If e.g. both temperature sensors are outside measuring range, info code 12 is displayed.

9. Plug-in modules

MULTICAL® 602 can be extended by a wide range of extra functions by means of plug-in modules. The individual modules are briefly described below.

9.1 Top modules

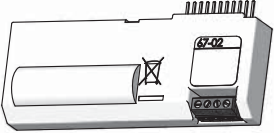
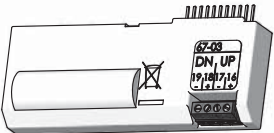
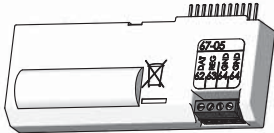
 <p>The image shows a rectangular plug-in module labeled '67-02'. It has a 9-pin D-sub connector on the top edge and a circular port on the front. A small label on the front indicates '67-02' and 'E2000'.</p>	<p>Type 67-02: ΔEnergy calculation and hourly data logger</p> <p>This top module calculates the difference between forward and return energy, whereby an expression of the tapped energy in open systems is obtained. Differential energy $dE=E4-E5$. The module also includes an hourly data logger.</p> <p>The connection terminals of this module are not used.</p>
 <p>The image shows a rectangular plug-in module labeled '67-03'. It has a 9-pin D-sub connector on the top edge and a circular port on the front. A label on the front indicates '67-03', 'DN, UP', and '19,18 17,16'.</p>	<p>Type 67-03: PQ-limiter + hourly data logger</p> <p>The module has two pulse outputs which can be used for UP/DOWN control of a low-speed three-point motor-operated valve via an external solid-state relay, type S75-90-006 and a 230/24 V transformer, type 66-99-403. The required power and flow limits are entered into MULTICAL® 602 by means of the PC-program METERTOOL. Also see instructions: 5512 -497. The module includes an hourly data logger too.</p>
 <p>The image shows a rectangular plug-in module labeled '67-05'. It has a 9-pin D-sub connector on the top edge and a circular port on the front. A label on the front indicates '67-05' and 'E2000'. Below the label, there are four terminals labeled 'DATA', 'REQ', 'GND', and 'GND' with corresponding numbers 62, 63, 64, and 64.</p>	<p>Type 67-05: Data output + hourly data logger</p> <p>The module has a galvanically separated data port which functions together with the KMP protocol. The data output can be used for e.g. connection of external communication units or other hardwired data communication which it is not expedient to carry out via optical communication on the meter's front. 62: DATA (brown)–63:REQ (white)–64: GND (green). Use data cable type 66-99-106 with 9-pole D-sub or type 66-99-098 with USB connector. The module includes an hourly data logger. Only current and accumulated data can be read. Hourly/daily/monthly/yearly data loggers cannot be read through the data port of top module 67-05.</p>

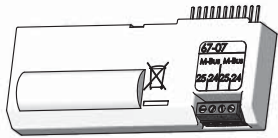

Type 67-07: M-Bus

M-Bus can be connected in star, ring and bus topology. Depending on M-Bus Master and cable length/cross section, up to 250 meters with primary addressing can be connected, and even more using secondary addressing.

Cable resistance in network: < 29 Ohm

Cable capacity of network: < 180 nF

The connection polarity of terminals 24-25 is unimportant.

Usually the primary address is identical with the last digits of the customer number (000-250). However, it can be changed by means of the PC program, METERTOOL.

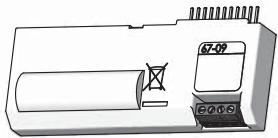

Type 67-09: ΔVolume calculation and hourly data logger

This top module calculates the difference between forward and return volume, whereby an expression of the tapped volume in open systems is obtained. Differential volume $dV=V1-V2$.

The module also includes an hourly data logger.

The connection terminals are not used in this module.

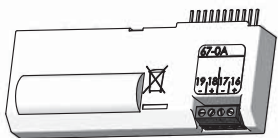

Type 67-0A: 2 pulse outputs for CE and CV + hourly data logger + scheduler

The top module has the same functions as top module 602-0C. Furthermore, the module can simulate a cold water temperature according to a programmed scheduler, in which T2, T3 or T4 can be programmed with up to 12 individual dates/temperatures per year.

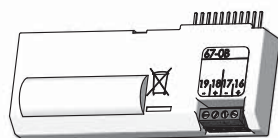

Type 67-0B: 2 pulse outputs for CE and CV + prog. data logger

The RTC and pulse output functions of this top module are identical with the functions described for top module 602-0C (see below).

The top module is prepared for use in a Kamstrup radio network together with High Power RadioRouter base module 6020084, read data being transferred to the system software via the network unit RF Concentrator.

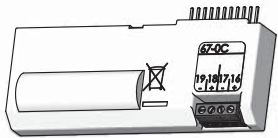

Type 602-0C: 2 pulse outputs for CE and CV

This top module has two configurable pulse outputs, which are suitable for volume and energy pulses for heat meters, cooling meters and combined heat/cooling meters.

The pulse resolution follows the display (determined by the CCC-code). E.g. CCC=119 (q_p 1,5): 1 pulse/kWh and 1 pulse/0.01 m³.

The pulse outputs are optoisolated and withstand 30 VDC and 10 mA.

Normally energy (CE) is connected to 16-17 and volume (CV) to 18-19, but other combinations can be selected by means of the PC program METERTOOL, which is also used for selecting the pulse at either 32 or 100 ms.

9.2 Base modules

9.2.1 Data + pulse inputs, type 67-00-10

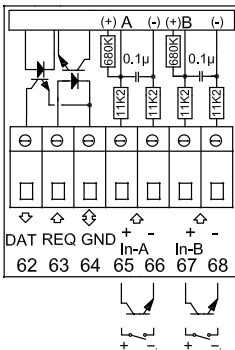

The data terminals are used for connection of e.g. a PC. The signal is passive and galvanically separated by means of optocouplers. Conversion into RS232 level requires connection of data cable 66-99-106 (D-Sub 9F) or 66-99-098 (USB) using the following connections:

62	Brown	(DAT)
63	White	(REQ)
64	Green	(GND)

The pulse inputs can be used for connection of electricity and water meters. Please pay attention to maximum pulse frequency as well as correct pulse coding (l/imp. and Wh/imp.), which is selected by means of the FF and GG configuration.

65 - 66 Input A

67 - 68 Input B

9.2.2 M-Bus, type 67-00-20/27/28/29

M-Bus can be mounted in star, ring or bus topology. Up to 250 meters can be connected depending on the M-Bus Master's power supply and the total cable resistance.

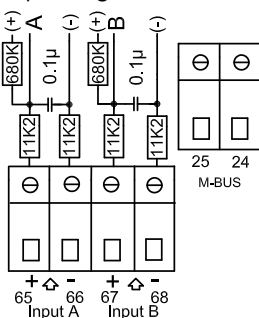

Cable resistance < 29 Ohm

Cable capacity < 180 nF

The M-Bus network is connected on terminals 24 and 25.

The polarity is unimportant.

M-Bus comes with pulse inputs.

9.2.3 Radio + pulse inputs, 67-00-21/25/26

The radio module is used for wireless communication via licence-free radio frequency and can be supplied with internal antenna or with connection for external antenna.

For further information on radio we refer to *Technical description for radio (5512-012)*.

The pulse inputs of this module are identical with the previously described pulse inputs.

Note! Type 67-00-21 includes radio and router functions.

The RadioRouter module (67-00-21) must be used with mains supply.

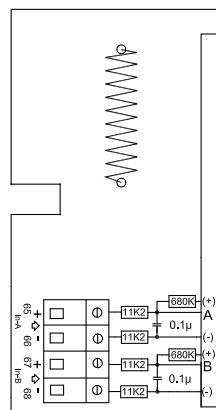

9.2.4 Prog. data logger + RTC + 4...20 mA inputs + pulse inputs, type 67-00-22

The module has connection possibility for two pressure transmitters on terminals 57, 58 and 59 and can be adjusted for current reading or pressure range 6, 10 or 16 bar.

The module is prepared for remote reading, data from meter/module being transferred to the system software via the external GSM/GPRS modem connected on terminals 62, 63 and 64.

Furthermore, the module has two extra pulse inputs, VA and VB.

The module must be powered by 24 VAC.

9.2.5 Analog outputs, type 67-00-23

See *installation instructions 5512-369 (DK-GB-DE)*.

9.2.6 Lon Works, type 67-00-24

See *installation instructions 5512-396 (DK) or 5512-403 (GB)*.

9.2.7 Wireless M-Bus, type 602-00-30/602-00-35

The radio module has been designed to form part of the hand-held Wireless M-Bus Reader systems of Kamstrup A/S at license-free radio frequency (868 MHz).

The module fulfils the C-mode specifications of prEN13757-4 and can thus form part of other systems using Wireless M-Bus C-mode communication.

The radio module comes with internal antenna and external antenna connection as well as two pulse inputs, which are identical with the previously described pulse inputs.

The Wireless M-Bus radio transmitter is switched off on dispatch from the factory. It turns on automatically when one litre of water has run through the meter. The radio transmitter can also be switched on by means of a forced dial-up to the meter (keep both front keys pressed for approx. 5 s. until CALL is displayed).

9.2.8 ZigBee® + pulse inputs, type 67-00-60

The ZigBee® module is used for wireless communication and can form part of a remote reading system, in which several units can communicate with each other.

The pulse inputs of this module are identical with the previously described pulse inputs. The ZigBee® module requires mains supply.

9.2.9 Metasys N2 + pulse inputs, type 67-00-62

The N2 module is used for data communication between meter and N2 Master in a Johnson Controls System.

The RS485 port is galvanically separated from the meter.

The pulse inputs of this module are identical with the previously described pulse inputs.

The N2 module requires mains supply.

9.2.10 SIOX module (Auto detect Baud rate), type 602-00-64

SIOX is used for data reading of small and medium-sized groups of heat meters via cable, the data readings being presented by the main system, e.g. Mcom, Fix or Telefrang. Further information on these systems can be ordered from the supplier in question. Furthermore, a configuration tool is available from Telefrang.

The two-wire serial SIOX bus connection is optoisolated from the meter and is connected without regard to polarity (i.e. the polarity is unimportant). The module is powered by the SIOX bus. Communication speed between 300 and 19,200 baud. The module automatically uses the highest possible communication speed. The module converts data from KMP protocol to SIOX protocol.

9.2.11 BACnet®, type 67-00-66

The BACnet® module communicates with BACnet® on MS/TP via RS-485 as a master/slave or slave device.

The BACnet® module transfers a number of both actual data as well as accumulated data.

Furthermore, info codes for general alarm, flow error, temperature, error, water leakage, pipe burst, air in system, and wrong flow direction can be transmitted to the BACnet® Controller.

The two pulse inputs allow connection and reading of two additional meters for e.g. water and electricity with pulse output.

9.2.12 GSM/GPRS module (GSM6H), type 602-00-80

The GSM/GPRS module functions as transparent communication path between reading software and MULTICAL® 602 and is used for data reading. The module includes an external dual-band GSM antenna which must be used. The module itself includes a number of light emitting diodes indicating the signal level, which are very useful during installation. The GSM/GPRS module must be used together with high-power mains supply (230 VAC: 602-00-00-2 and 24 VAC: 602-00-00-3).

9.2.13 3G module (GSM8H 3G), type 602-00-81

Like GSM6H, the module functions as a transparent communication route between readout software and MULTICAL® 602 and is used for data reading.

However, this module supports both 2G (GSM/GPRS) and 3G (UMTS), which also makes it applicable in areas where there is only 3G coverage.

The module must always be used together with an external antenna that covers both 900 MHz, 1800 MHz and 2100 MHz. The module is equipped with a number of light emitting diodes that indicate the signal level, which is very useful during installation. In addition, it is indicated whether the module is connected to a 2G or 3G network.

For further details about the 3G module, see datasheets

(DK: 5810-1057, GB: 5810-1058, DE: 5810-1059, FI: 5810-1061, and SE: 5810-1060).

For further details about installation, see installation guides

(DK: 5512-1121, GB: 5512-1122, DE: 5512-1123, FI: 5512-1124 and SE: 5512-1125).

The 3G module must be used together with High Power mains supply (230 VAC: 602-00-00-3 and 24 VAC: 602-00-00-4).

9.2.14 Ethernet/IP module (IP201), type 602-00-82

The IP module functions as transparent communication between reading software and MULTICAL® 602 and is used for data reading. The Module supports both dynamic and static addressing. This is specified in the order or selected during subsequent configuration. The module has no built-in security and must, therefore, always be used in connection with a firewall or NAT. The Ethernet/IP module must be used together with high-power mains supply (230 VAC: 602-00-00-2 and 24 VAC: 602-00-00-3).

9.2.15 High-Power RadioRouter + 2 pulse inputs (VA, VB), type 602-00-84

The High-Power RadioRouter module has built-in router functionality and is thus optimized to form part of a Kamstrup radio network, the read data being automatically transferred to system software via the network unit RF Concentrator. Furthermore, the module can be read by Kamstrup's hand-held reading systems, e.g. USB Meter Reader and MULTITERM Pro.

The RadioRouter module is available for operation in both licence-free and licence demanding frequencies permitting a transmitting strength of up to 500 mW. The module is by default fitted with internal antenna, connection for external antenna, and two extra pulse inputs. The High Power RadioRouter module (602-00-84) must be used together with the High Power mains supply (230 VAC: 602-00-00-2 and 24 VAC: 602-00-00-3).

9.3 Module overview

MULTICAL® 602 Communication modules #2

Type No.	Description	Module No.
67-02	RTC + Denergy calculation + hourly data logger	5550-860
67-03	RTC + PQ eller Dt limiter + hourly data logger	5550-860
67-05	RTC + data output + hourly data logger	5550-904
67-07	RTC + M-Bus	5550-838
67-09	RTC + DVolume + hourly data logger	5550-860
67-0A	RTC + 2 pulse outputs for CE and CV + hourly data logger + scheduler	5550-860
67-0B	RTC + 2 pulse outputs for CE and CV + prog. data logger	5550-942
602-0C	2 pulse outputs for CE and CV	5550-1163

MULTICAL® 602 Communication modules #1

Type No.	Description	Module No.
67-00-10	Data + pulse inputs (VA, VB)	5550-369
67-00-20	M-Bus + pulse inputs (VA, VB)	5550-831
67-00-21	RadioRouter + pulse inputs (VA, VB)	5550-805
67-00-22	Prog. data logger + RTC + 4...20 mA inputs + pulse inputs (VA, VB)	5550-925
67-00-23	0/4...20 mA outputs	5550-1005
67-00-24	LonWorks, FTI-10A + pulse inputs (VA, VB)	5550-1128
67-00-25	Radio + pulse inputs (VA, VB) (internal antenna)	5550-608
67-00-26	Radio + pulse inputs (VA, VB) (for external antenna)	5550-640
67-00-27	M-Bus module with alternative registers + pulse inputs	5550-997
67-00-28	M-Bus module with medium data package + pulse inputs	5550-1104
67-00-29	M-Bus module with MC III data package + pulse inputs	5550-1125
602-00-30	Wireless M-Bus, C1, standard registers, encrypted, 868 MHz, internal and external antennas, pulse inputs	5550-1205
602-00-35	Wireless M-Bus, C1, alternative registers, encrypted, 868 MHz, internal and external antennas, pulse inputs	5550-1206
67-00-60	ZigBee® 2.4 GHz internal antenna + pulse inputs	5550-992
67-00-62	Metasys N2 (RS-485) + 2 pulse inputs (VA, VB)	5550-1110
602-00-64	SIOX module (Auto detect baud rate)	5920-193
67-00-66	BACnet MS/TP (B-ASC) RS-485 + 2 pulse inputs	5550-1240
602-00-80	GSM/GPRS module (GSM6H)	5550-1137
602-00-81	3G GSM/GPRS module (GSM8H)	5550-1209
602-00-82	Ethernet/IP module (IP201)	5550-844
602-00-84	High Power Radio Router + pulse inputs	5550-1116

10. Setup via front keys

Date, time and primary M-Bus address can be adjusted by means of the keys on the calculator's front.

- 1 In the display you select the reading you want to change
- 2 Lift off the calculator top
- 3 Wait until the meter has shut down (up to 2.5 minutes). Do not press any keys
- 4 While remounting the calculator top, keep the main key  until there are no more lines in the display.
- 5 The setup menu is now active.

Having activated the setup menu the reading you want to change is displayed with the rightmost digit flashing:





The value of the flashing digit can be changed by pressing the sub-key . The digit is increased by one each time the key is pressed, and passing 9 you start from 0:



Pressing the main key  you go to the next digit from right to left:



The active digit flashes and this digit can now be changed by pressing the sub-key . You go to the first digit on the right by means of the main key .

When the value of the reading has been changed you quit by pressing the main key  continuously for approx. 10 seconds.

It should be checked whether the value is valid for the reading in question. If so, the value is saved and an "OK" symbol is displayed. If not, the old value is maintained, no "OK" symbol appears, and the display reverts to legal reading.

Current energy in
MWh or G



E3
0004793
MWh



DATE LOG 0
20110601

Latest yearly target date

LOG 0
0003787
MWh

Energy consumption count on latest yearly target date, followed by previous yearly target date.
Followed by monthly target date data

VOL 1
0032456
m³

DATE LOG 0
20110601

Latest yearly target date

LOG VOL 0
0025641
m³

District cooling water volume count on latest yearly target date, followed by previous yearly target date.
Followed by monthly target date data

0008760
h

TIME N 60
14

Number of hours with errors

Current flow pipe
temperature

t 1
10.33
°C

t 1
8
°C

Yearly average inlet temperature.

t 1
12
°C

Monthly average inlet temperature.
MFI: Monthly average temperature is reset every month, depending on target date.

Current return pipe
temperature



t 2
15.74
°C



t 2
14
°C

Yearly average outlet temperature.

t 2
17
°C

Monthly average outlet temperature.
MFI: Monthly average temperature is reset every month, depending on target date.

t 12
5.41
K

t 12
-
K

Current water flow
Press to see the peak value of the current year and historic yearly and monthly values.

VOL 1
3.16
l/h

Current cooling power
Press to see the peak value of the current year and historic yearly and monthly values.
Followed by the accumulated water consumption on inputs A and B and tariff registers TA2 and TA

2.0
kW

Current information code
(contact the utility if the figure differs from "0")

INFO
256

... and the INFO code of the latest 36 changes

INFO LOG 0
20110104
2048

Data logger indicates the date ...

Indication of the number of current and corrected error conditions

Number of operating

Number of operating

