

EB-100
EB-250

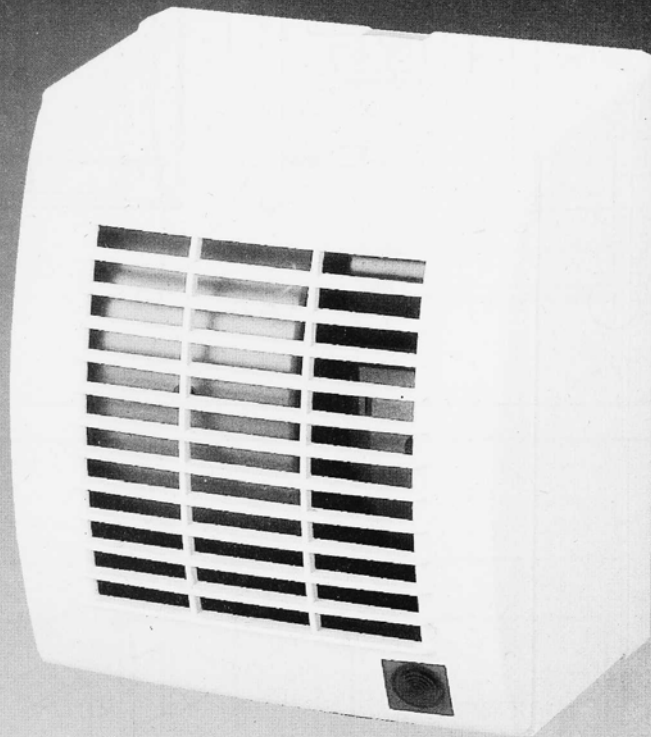

Instrucciones de uso
User instructions
Notice d'utilisation
Montageanweisungen
Montage-Gebruiksaanwijzing
Instruções de utilização
Libretto istruzioni
Instrukcja obsługi i montażu

Fig. 1

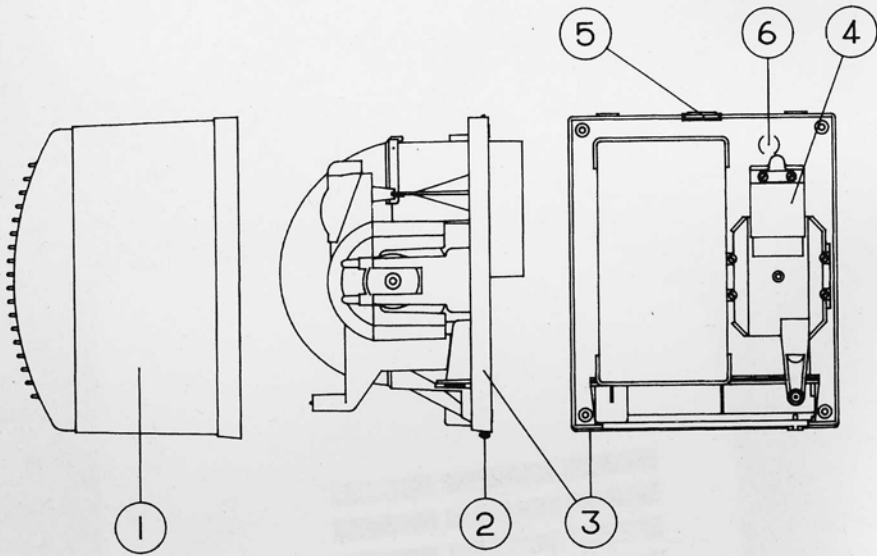

Fig. 2

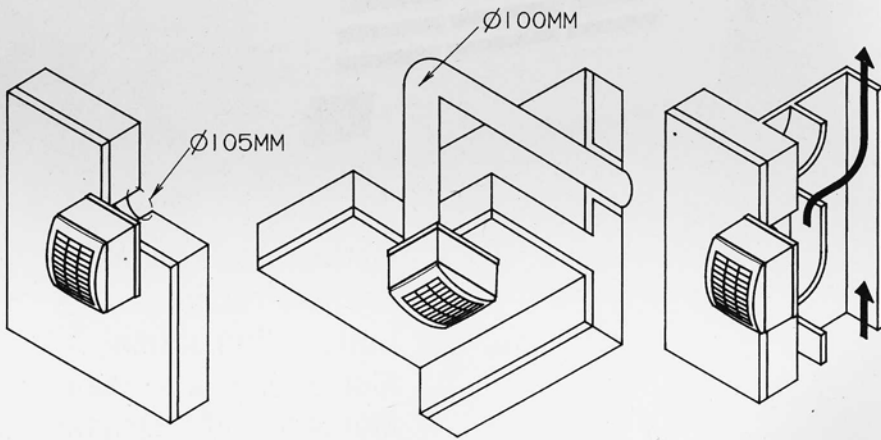

Fig. 3

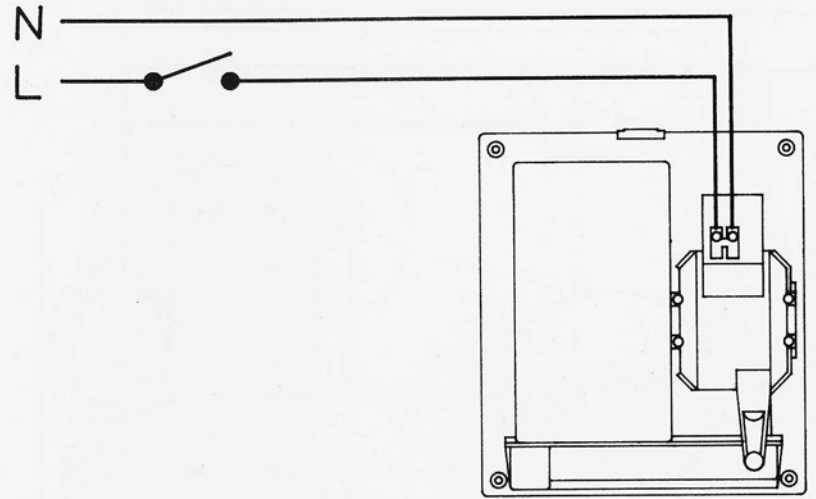

Fig. 4

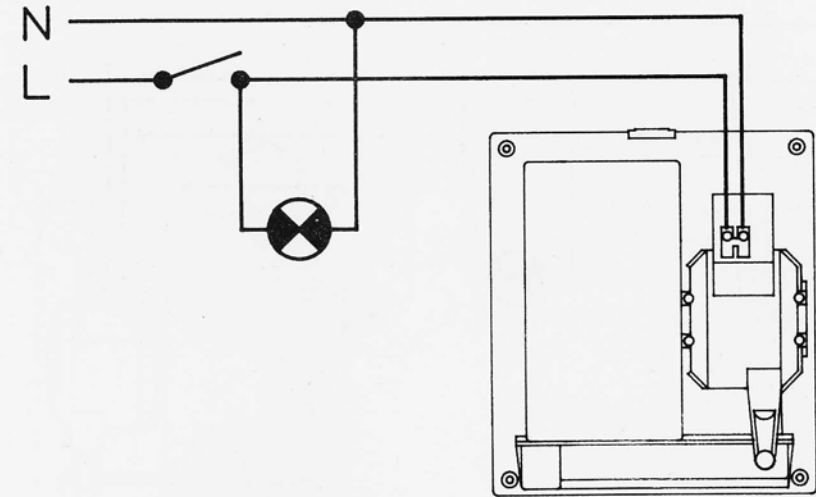

Fig. 5

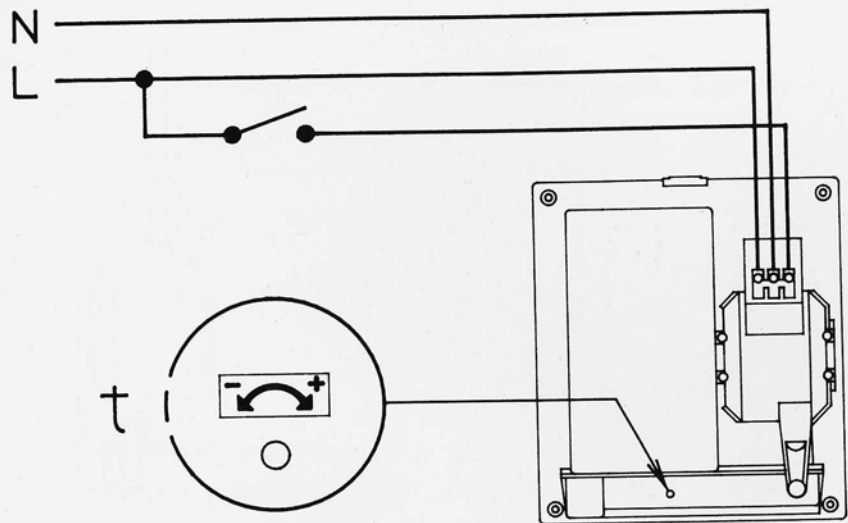

Fig. 7

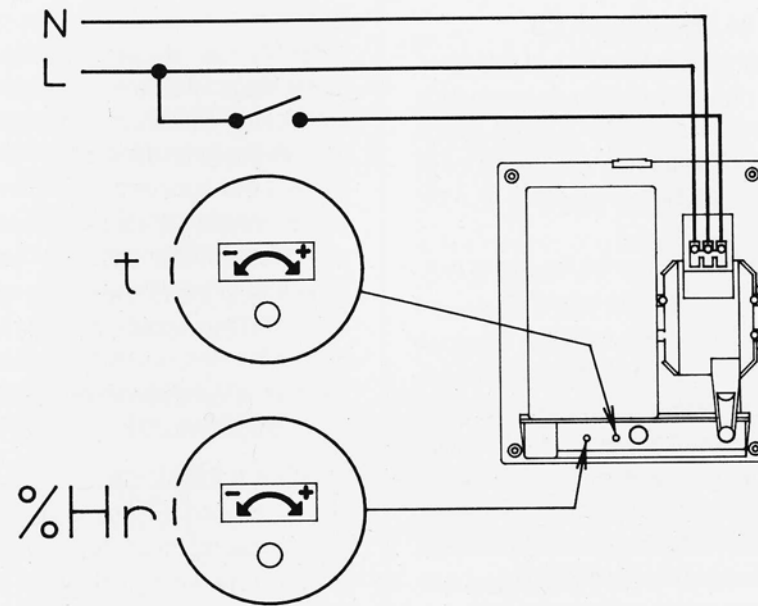

Fig. 6

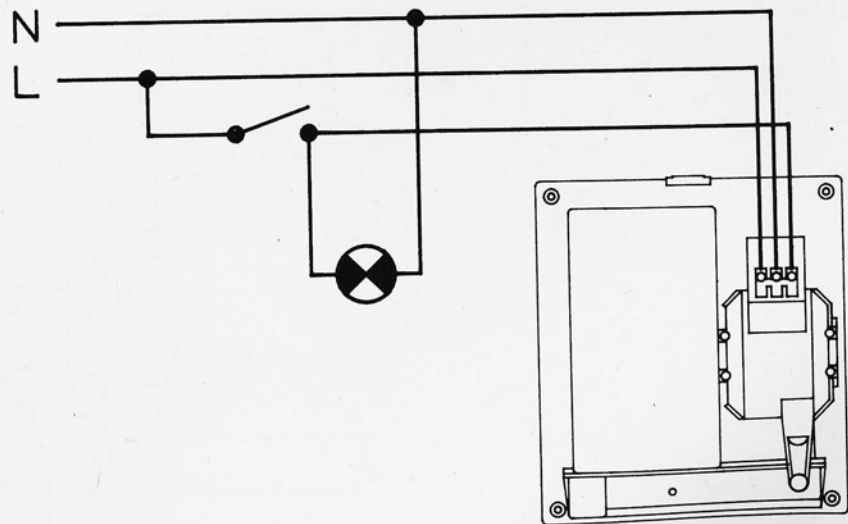
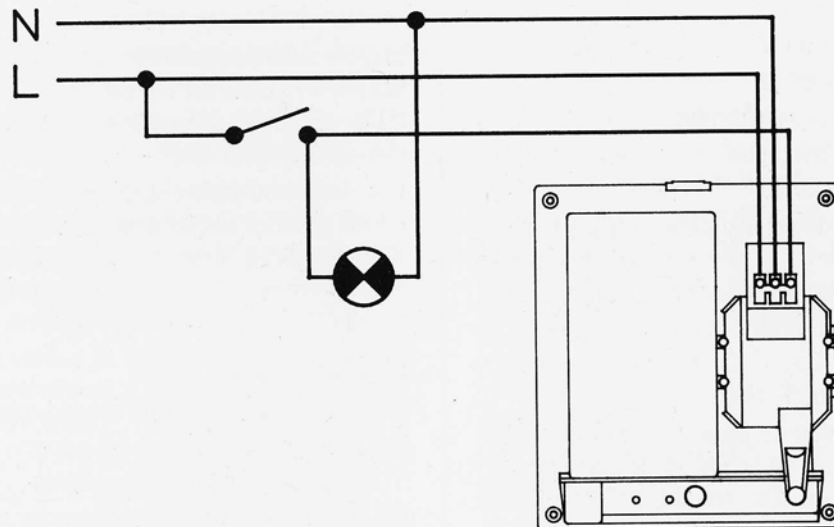

Fig. 8



ENGLISH

EB Centrifugal Extractors

The EB range extractors have been manufactured to the rigorous standards of production and quality as laid down by the international Quality Standards ISO 9001. All the components have been checked and all the final products have been tested at the end of the manufacturing process.

We recommend that you to check the following when receiving this product:

1. That it is the correct size.
2. That it is the correct model.
3. That the details on the rating label are those you require: voltage, frequency...

The installation must be in accordance with the electrical standards in force in your country.

Installation

IMPORTANT: Before installing and wiring the EB, ensure that the main supply is disconnected.

Fig. 1:

- 1 - Protection grille
- 2 - Fixing screw
- 3 - Fan support
- 4 - Connection terminals cover
- 5 - Cable entry
- 6 - Slot

The EB can be wall or ceiling mounted, and it can discharge directly to the outside or through a duct (individual or common duct, Fig. 2).

The hole to be made in the wall or the ceiling must be 105 mm in diameter.

Loosen the screw (4) fixing the protection grille (1).

If the installation is made to an individual ducting, use standards ducting of 100 mm

diameter. Smaller diameter must not be used. If it is necessary to bend the duct at the discharge of the fan, make the radius as large as possible.

Before fixing the fan support (3), ensure that there are no obstructions to the airflow, that the shutter mounted at the fan discharge opens easily and that the impeller turns freely. Fix the support to the wall with the 4 plugs and screws supplied in the packaging. Loosen the screws of cover (4) to gain access to the connection terminals. Connect the electrical wiring as follows.

Electrical connection

The EB is an extractor designed for a single phase supply, with voltage and frequency as indicated on the rating plate of the unit. The units are made with double electrical insulation (Class II) and therefore they do not need an earth connection.

The electrical installation must include a double pole switch with a contact clearance of at least 3 mm.

The electrical cable must be introduced to the EB through the slot (6) if the wire is within the wall, or through the cable entry (5) if the installation is made with a surface mounted cable.

Once the cable has been introduced, proceed to the appropriate electrical wiring depending on the EB model.

EB Modells S

For these models use the following diagrams:

Fig. 3 To switch the fan through an independent switch.

Fig. 4 Switching the extractor through the light switch.

EB Modells T

Models fitted with fixed with an adjustable timer, variable between 1 and 30 minutes.

The timer enables the extractor to continue running during the time delay, after the supply has been switched off.

The diagram on Fig. 5 shows how to connect a unit fitted with timer using an independent switch.

The diagram on Fig. 6 shows how to connect a unit fitted with timer using the light switch.

To adjust the timer, turn the potentiometer in the lower part of the fan with a small screwdriver:

- To increase the time delay turn it Clockwise (CW).
- To decrease the time delay turn it Counter Clockwise (CCW).

EB Modells HT

This model is provided with an electronic hygrostat which can be adjusted from 60 to 90% RH (% relative humidity).

The two functions, timer and humidity control, are independent.

The adjustment are carried out with the potentiometer in the lower part of the appliance (Fig. 7).

To adjust the timer, turn the left potentiometer with a small screwdriver:

- To increase the time delay turn it Clockwise (CW).
- To decrease the time delay turn it Counter Clockwise (CCW).

To adjust the humidity level above which the fan will operate automatically, turn the right potentiometer with a small screwdriver.

Operation

The timer will operate when the Switch (independent switch or light switch) is switched off.

The hygrostat causes the extractor to operate automatically when the humidity level in the room is higher than the level selected with the potentiometer.

Likewise, the extractor will stop automatically when the humidity level drops below the selected level.

The diagram on Fig. 7 shows how to connect the unit through an independent switch.

The diagram on Fig. 8 shows how to connect the unit through the light switch.

Maintenance

The extractor needs only a periodical cleaning using a cloth lightly impregnated with a soft detergent.

After Sales Service

We recommend you not to try to dismantle or remove any other parts than those mentioned as any tampering would automatically cancel the S&P guarantee. If you detect any fault, contact your S&P dealer.

S&P reserves the right to alter specifications without notice.