

technical data



Rooftops

UATP180-C12AY1

R-407C



technical data

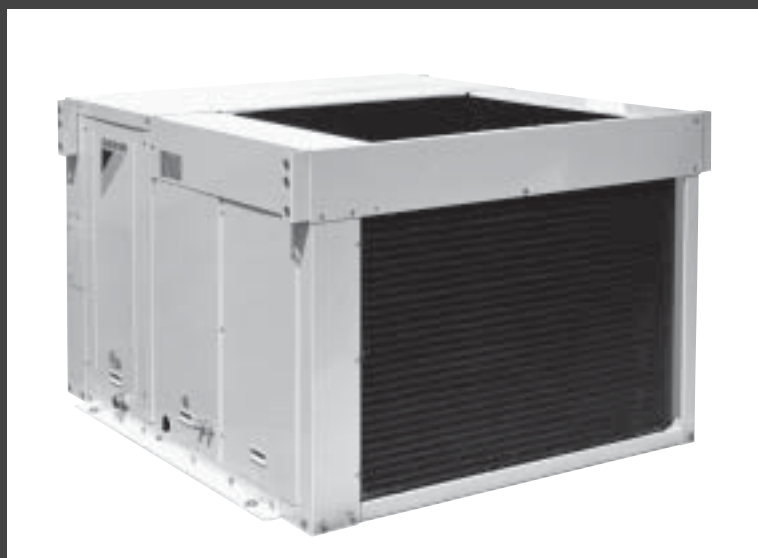

Rooftops

UATP180-C12AY1

R-407C



Cooling only



TABLE OF CONTENTS

UATP-AMY1

1	Features	1
2	Specifications	2
	Capacity and Power Input	2
	Technical Specifications	2
	Electrical Specifications	3
3	Nomenclature	4
4	Features	5
5	Safety device settings	6
6	Control systems	7
7	Capacity tables	10
	Cooling capacity tables	10
8	Dimensional drawing & centre of gravity	19
	Dimensional drawing	19
9	Piping diagram	23
10	Wiring diagram	26
	Wiring diagram	26
11	Sound data	31
	Sound pressure spectrum	31
12	Fan characteristics	33
13	Operation range	37

1 Features

- Easy to install 'plug and play' concept plus single installation configuration. No additional piping is required since indoor and outdoor sides are pre-connected.
- Factory pre-charged refrigerant ensures clean and efficient operation.
- Belt driven fan enables air volume and static pressure to be adjusted as required.
- Flat top unit design allows maximum utilization of warehouse and container space.
- High efficiency and reliable scroll compressor.
- Fan can be mounted for horizontal or vertical airflow inlet and discharge (UATP240-560AMY1 only).
- Anti-corrosion treated coil.



SLM or sequential controller

2 Specifications

2-1 CAPACITY AND POWER INPUT				UATP180AMY1	UATP240AMY1	UATP280AMY1	UATP320AMY1	UATP450AMY1
Cooling	Minimum	kW		17.291	21.101	27.842	32.238	41.030
Power Input	Cooling	Nominal	kW	5.89	8.70	11.60	12.18	17.20
EER	Nominal			2.94	2.43	2.40	2.65	2.39

2-1 CAPACITY AND POWER INPUT				UATP560AMY1	UATP700AMY1	UATP850AMY1	UATPC10AMY1	UATPC12AMY1
Cooling	Minimum	kW		55.684	67.406	82.939	97.007	121.624
Power Input	Cooling	Nominal	kW	25.10	28.70	40.16	41.87	48.80
EER	Nominal			2.22	2.35	2.07	2.32	2.49

2-2 TECHNICAL SPECIFICATIONS				UATP180AMY1	UATP240AMY1	UATP280AMY1	UATP320AMY1	UATP450AMY1
Evaporator	Control	Air Discharge		Ducted				
		Operation		SLM Controller	SLM Controller	SLM Controller	SLM Controller	Sequential Controller
	Air Flow Rate	Cooling	m ³ /min	51	80	100	102	160
	External Static Pressure		Pa	98	98	98	98	196
Piping connections	Condensation Drain Size	Diameter (OD)	mm	25.4	25.4	25.4	25.4	25.4
Condensator	Casing	Colour		Light Grey				
		Material		Electro galvanised mild steel				
Dimensions	Unit	Height	mm	1,000	1,000	1,000	1,000	1,200
		Width	mm	1,100	1,300	1,300	1,300	1,990
		Depth	mm	1,530	1,530	1,530	1,530	1,670
	Packing	Height	mm	1,090	1,090	1,090	1,090	1,320
		Width	mm	1,250	1,450	1,450	1,450	2,100
		Depth	mm	1,608	1,680	1,680	1,680	1,810
Condensator	Weight	Unit	kg	295	370	400	425	665
Heat Exchanger	Dimensions	Face Area	m ²	1.41	1.41	1.41	1.41	2 x 1.25
Condensator	Air Flow Rate	Cooling	m ³ /min	127	160	160	227	320
	Motor	Output	W	400	550	550	580	550
	Compressor	Quantity		1	1	1	1	2
Compressor	Motor	Type		Scroll type				
Operation Range	Cooling	Min	°CDB	20°C				
		Max	°CDB	46°C				
Condensator	Sound Level (nominal)	Sound power	dB(A)	63	65	66	68	70
	Refrigerant	Type		R-407C				
		Charge	kg	4.6	4.6	5.9	5.6	2 x 3.9
		Control		Thermal expansion valve	Capillary tube	Capillary tube	Thermal expansion valve	Capillary tube
	Safety Devices		High pressure switch					
			Discharge thermostat setting	Discharge thermostat setting	Discharge thermostat setting	Discharge thermostat setting		
	Notes		All specifications are subjected to change by the manufacturer without prior notice.					
		All units are being tested and comply to ISO5151.						
		Nominal cooling and heating capacity are based on the following conditions: cooling -27°CDB/19°CWB indoor and 35°CDB/24°CWB outdoor, heating -20°CDB indoor and 7°CDB/6°CWB outdoor.						
		Sound pressure levels are according to JIS B 8615 standard. Position of the measurement is 1m in front and 1m below the unit.						
		Designation based on cooling cycle.						

2-2 TECHNICAL SPECIFICATIONS				UATP560AMY1	UATP700AMY1	UATP850AMY1	UATPC10AMY1	UATPC12AMY1
Evaporator	Control	Air Discharge		Ducted				
		Operation		Sequential Controller				
	Air Flow Rate	Cooling	m ³ /min	190	227	263	312	354
	External Static Pressure		Pa	196	294	294	294	294
Piping connections	Condensation Drain Size	Diameter (OD)	mm	25.4	25.4	25.4	25.4	25.4
Condensator	Casing	Colour		Light Grey				
		Material		Electro galvanised mild steel				

2 Specifications

1
2

2-2 TECHNICAL SPECIFICATIONS				UATP560AMY1	UATP700AMY1	UATP850AMY1	UATPC10AMY1	UATPC12AMY1	
Dimensions	Unit	Height	mm	1,200	1,735	1,735	1,974	1,974	
		Width	mm	1,990	2,250	2,250	2,252	2,252	
		Depth	mm	1,670	2,800	2,800	3,180	3,180	
	Packing	Height	mm	1,320	1,900	1,900	2,150	2,150	
		Width	mm	2,100	2,250	2,250	2,300	2,300	
		Depth	mm	1,810	2,900	2,900	3,250	3,250	
Condensor	Weight	Unit	kg	765	1,200	1,350	1,510	1,600	
Heat Exchanger	Dimensions	Face Area	m ²	2 x 1.25	2 x 3.00	2 x 3.00	3.50	3.50	
Condensor	Air Flow Rate	Cooling	m ³ /min	320	566	566	566	566	
	Motor	Output	W	550	1,500	1,500	3,465	3,465	
	Compressor	Quantity		2	2	2	2	2	
Compressor	Motor	Type		Scroll type					
Operation Range	Cooling	Min	°CDB	20°C					
		Max	°CDB	46°C					
Condensor	Sound Level (nominal)	Sound power	dBA	70	74	74	80	80	
		Refrigerant	Type	R-407C					
	Control	Charge	kg	2 x 4.2	2 x 9.6	2 x 10.4	14.5 & 18.0	2 x 18.0	
		Control		Capillary tube	Thermal expansion valve	Thermal expansion valve	Thermal expansion valve	Thermal expansion valve	
	Safety Devices				High pressure switch				
					Discharge thermostat setting	Discharge thermostat setting	Phase sequencer	Phase sequencer	
							Discharge thermostat setting	Discharge thermostat setting	
	Notes	All specifications are subjected to change by the manufacturer without prior notice.							
		All units are being tested and comply to ISO5151.							
		Nominal cooling and heating capacity are based on the following conditions: cooling -27°CDB/19°CWB indoor and 35°CDB/24°CWB outdoor, heating -20°CDB indoor and 7°CDB/6°CWB outdoor.							
Sound pressure levels are according to JIS B 8615 standard. Position of the measurement is 1m in front and 1m below the unit.									
Designation based on cooling cycle.									

2-3 ELECTRICAL SPECIFICATIONS				UATP180AMY1	UATP240AMY1	UATP280AMY1	UATP320AMY1	UATP450AMY1
Power Supply	Name			Y1				
	Phase			3~				
	Frequency		Hz	50	50	50	50	50
	Voltage		V	380-415				
Current	Nominal running current (RLA)	Cooling (A)	A	10.9	16.3	20.2	22.8	32.1

2-3 ELECTRICAL SPECIFICATIONS				UATP560AMY1	UATP700AMY1	UATP850AMY1	UATPC10AMY1	UATPC12AMY1
Power Supply	Name			Y1				
	Phase			3~				
	Frequency		Hz	50	50	50	50	50
	Voltage		V	380-415				
Current	Nominal running current (RLA)	Cooling (A)	A	43.8	53.0	68.5	74.2	83.7

3 Nomenclature

UATP180AY1



Power Supply

Y1: 380-415V, 3ph, 50Hz

Series

A: A series

Capacity

180: kWx10 \cong 18kW
C10: kWx10 \cong 100kW
C12: kWx10 \cong 120kW

Refrigerant

P: R-407C

Model name

UAT: Rooftops

4 Features

1
4

UATP														
Model	Classification													
	SLM Controller	Seq. Controller	Capillary Tube	Thermal Expansion Valve (TXV)	Normal Fin	Anticorrosion treatment	Reciprocating compressor	Scroll Compressor	Air Filter	Down Flow	Side Flow	Convertible	Filter Drier	
Heat pump	UATP180AY1	X			X		X		X	X		X		X
	UATP240AY1	X		X			X		X	X		X	X	X
	UATP280AY1	X		X			X		X	X		X	X	X
	UATP320AY1	X			X		X		X	X		X	X	X
	UATP450AY1		X	X			X		X	X		X	X	X
	UATP560AY1		X	X			X		X	X		X	X	X
	UATP700AY1		X		X		X		X			X		X
	UATP850AY1		X		X		X		X			X		X
	UATPC10AY1		X		X		X		X	X		X		X
	UATPC12AY1		X		X		X		X	X		X		X

5 Safety device settings

MODEL			UATP180AY1	UATP240AY1
SAFETY DEVICE	HIGH PRESSURE SWITCH	TYPE	NC	
		OPEN	kPa / psi	3241 / 470
		CLOSE	kPa / psi	2648 / 384
	LOW PRESSURE SWITCH	TYPE	N / A	
		OPEN	kPa / psi	N / A
		CLOSE	kPa / psi	N / A
	PHASE SEQUENCER			N / A
DISCHARGE THERMOSTAT SETTING			°C / °F 125 / 257	

MODEL			UATP280AY1	UATP320AY1
SAFETY DEVICE	HIGH PRESSURE SWITCH	TYPE	NC	
		OPEN	kPa / psi	3241 / 470
		CLOSE	kPa / psi	2648 / 384
	LOW PRESSURE SWITCH	TYPE	N / A	
		OPEN	kPa / psi	N / A
		CLOSE	kPa / psi	N / A
	PHASE SEQUENCER			N / A
DISCHARGE THERMOSTAT SETTING			°C / °F 125 / 257	

MODEL			UATP450AY1	UATP560AY1
SAFETY DEVICE	HIGH PRESSURE SWITCH	TYPE	NC	
		OPEN	kPa / psi	3241 / 470
		CLOSE	kPa / psi	2648 / 384
	LOW PRESSURE SWITCH	TYPE	N / A	
		OPEN	kPa / psi	N / A
		CLOSE	kPa / psi	N / A
	PHASE SEQUENCER			N / A
DISCHARGE THERMOSTAT SETTING			°C / °F 125 / 257	

MODEL			UATP700AY1	UATP850AY1
SAFETY DEVICE	HIGH PRESSURE SWITCH	TYPE	NC	
		OPEN	kPa / psi	3241 / 470
		CLOSE	kPa / psi	2648 / 384
	LOW PRESSURE SWITCH	TYPE	N / A	
		OPEN	kPa / psi	N / A
		CLOSE	kPa / psi	N / A
	PHASE SEQUENCER			N / A
DISCHARGE THERMOSTAT SETTING			°C / °F 125 / 257	

MODEL			UATPC10AY1	UATPC12AY1
SAFETY DEVICE	HIGH PRESSURE SWITCH	TYPE	NC	
		OPEN	kPa / psi	3241 / 470
		CLOSE	kPa / psi	2648 / 384
	LOW PRESSURE SWITCH	TYPE	N / A	
		OPEN	kPa / psi	N / A
		CLOSE	kPa / psi	N / A
	PHASE SEQUENCER			YES
DISCHARGE THERMOSTAT SETTING			°C / °F 125 / 257	

1) ALL SPECIFICATIONS ARE SUBJECTED TO CHANGE BY THE MANUFACTURER WITHOUT PRIOR NOTICE.

6 Control systems

Control Module Of Unit UATP180AY1

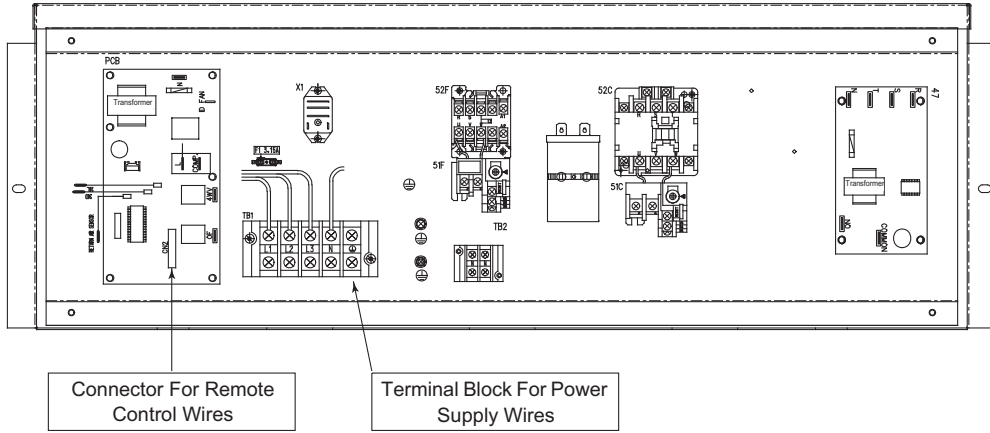

Control Module Of Unit UATP240/280AY1

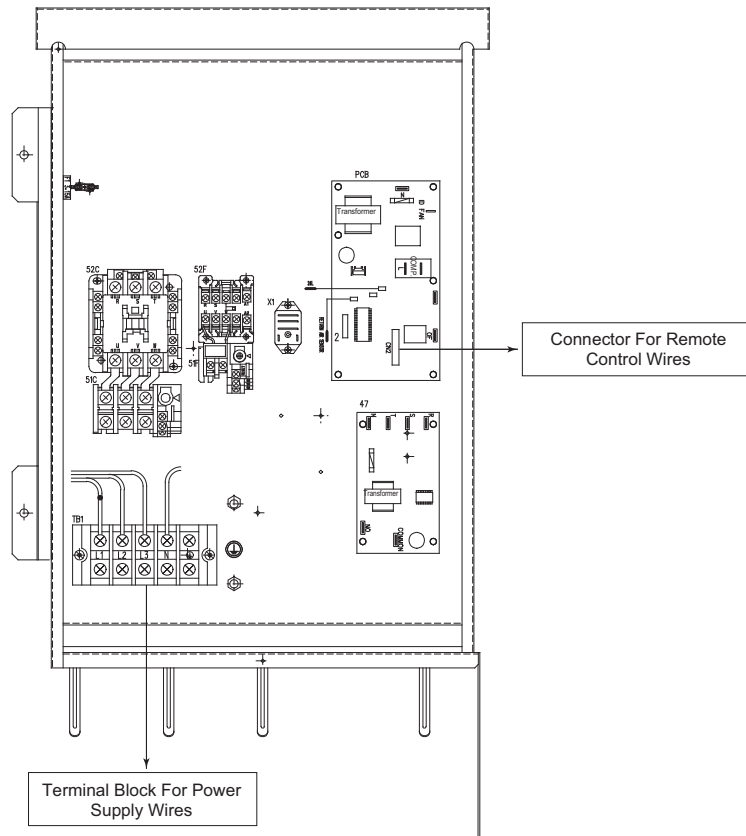

1

6

6 Control systems

Control Module Of Unit UATP320AY1

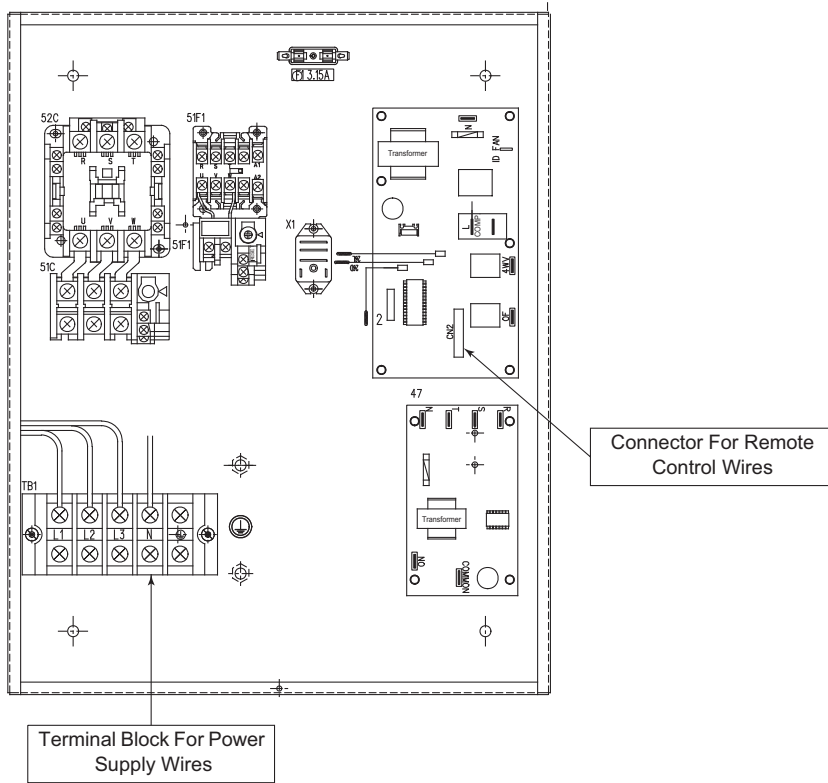

Control Module Of Unit UATP450/560AY1

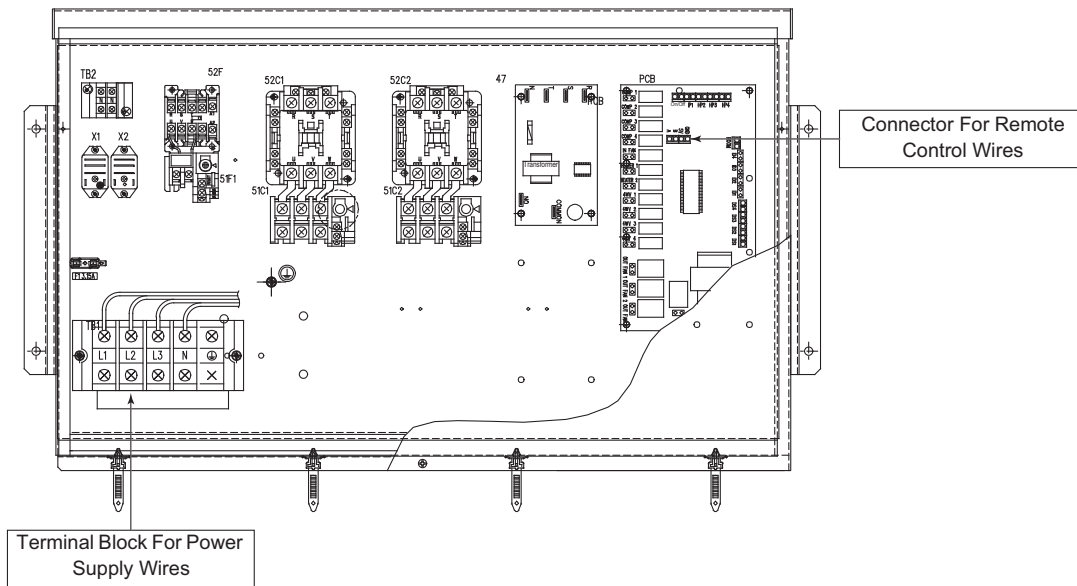

6 Control systems

1
6

Control Module Of Unit UATP700/850AY1

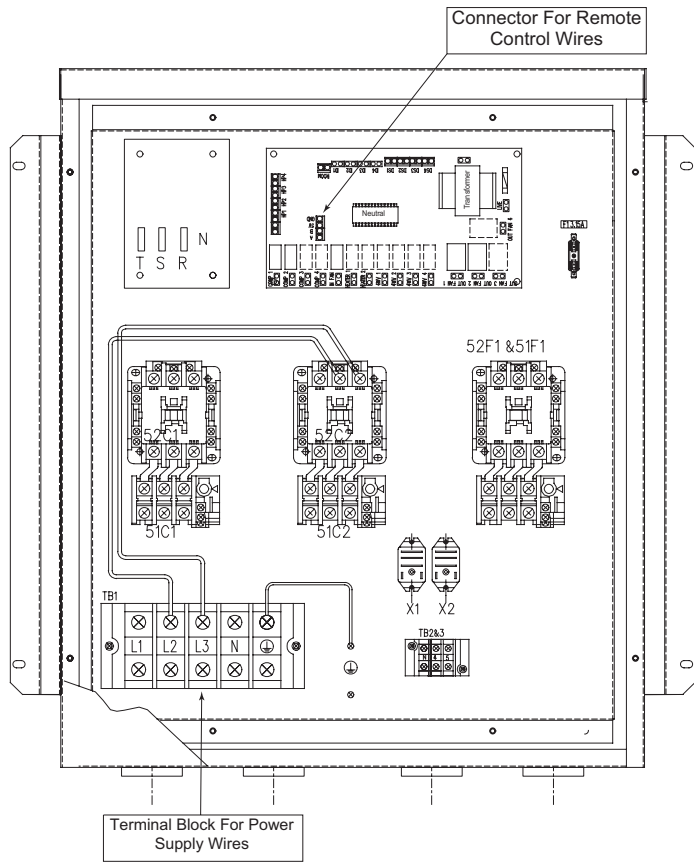

Control Module Of Unit UATPC10/12AY1

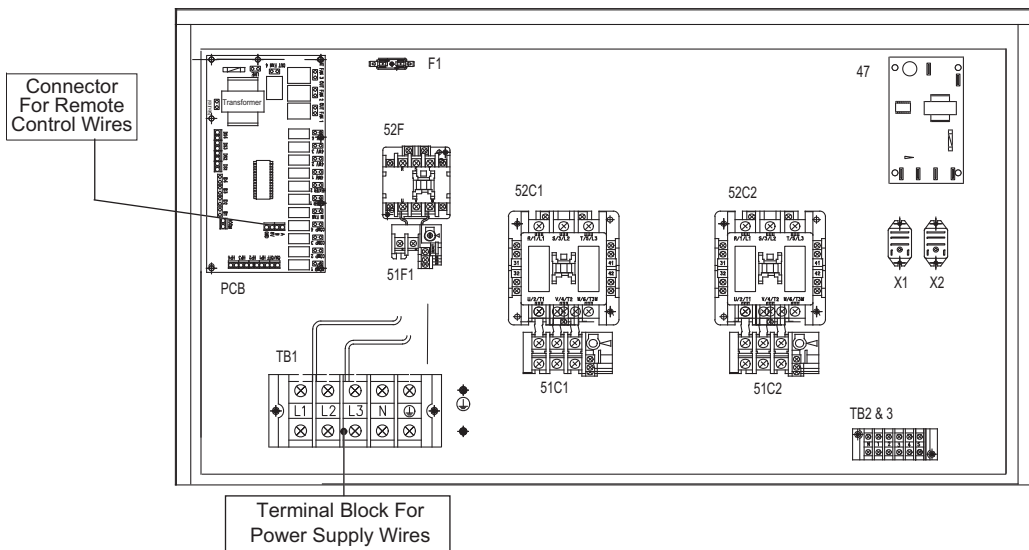

7 Capacity tables

7 - 1 Cooling capacity tables

SELECTION PROCEDURE

PERFORMANCE DATA

Performance table

Interpolation and extrapolation method can be used to get the total capacity, Q and sensible capacity, SC at those temperatures which are not stated out in the table.

Example:

Model: UAT700AY1

Indoor Condition: 23°C DB, 15°C WB

Outdoor condition: 37°C DB

Solution:

Overall

Based on the Performance table of UAT700AY1,

1. Refer to the indoor DB Column,
- **23°C** is located between 20°C and 24°C (Thus, Interpolation need to be applied)
2. Refer to the indoor WB Column,
- **15°C** only available in the case of indoor DB = 20°C. (Thus, extrapolation between 16°C WB and 17°C WB during 24°C indoor DB is required)
3. Refer to the indoor DB Column,
- **37°C** is located between 35°C and 40°C. (Thus, Interpolation need to be applied)

Please follow the steps below in order to get the required capacity.

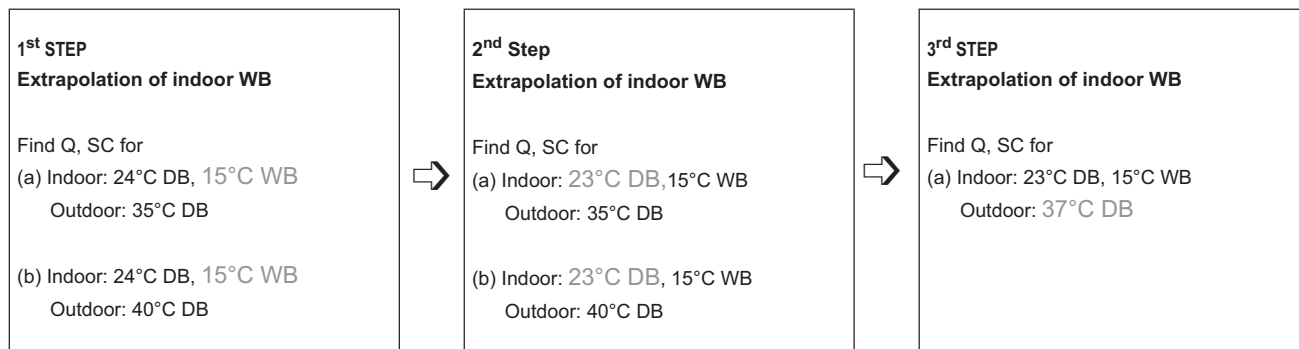

7 Capacity tables

7 - 1 Cooling capacity tables

Details:

1st Step:

To obtain the Total capacity and Sensible capacity for

(a) Indoor Condition: 24°C DB, 15°C WB

Outdoor Condition: 35°C DB

Indoor DB °C	Indoor WB °C	Outdoor DB°C	
		35	
		TC(kW)	SC(kW)
		!	!
24	15	x ₁	y ₁
	16	66.820	48.857
	17	68.717	47.070

Total capacity, Q

⇒ x₁ = 64.922 kW (Same as total capacity at 20°C Indoor DB / 15°C Indoor WB & 35°C Outdoor WB)*

Sensible capacity, Q

Extrapolation method:

$$\Rightarrow \frac{17^{\circ}\text{C} - 15^{\circ}\text{C}}{17^{\circ}\text{C} - 16^{\circ}\text{C}} = \frac{47.070\text{kW} - y_1}{47.070\text{kW} - 48.857\text{kW}}$$

$$\Rightarrow y_1 = 50.644 \text{ kW}$$

(b) Indoor Condition: 24°C DB, 15°C WB

Outdoor Condition: 40°C DB

Indoor DB °C	Indoor WB °C	Outdoor DB°C	
		40	
		TC(kW)	SC(kW)
		!	!
24	15	x ₁	y ₁
	16	61.569	45.442
	17	63.306	44.369

Total capacity, Q

⇒ x₂ = 59.831 kW (Same as total capacity at 20°C Indoor DB / 15°C Indoor WB & 40°C Outdoor WB)*

Sensible capacity, SC

Extrapolation method:

$$\Rightarrow \frac{17^{\circ}\text{C} - 15^{\circ}\text{C}}{17^{\circ}\text{C} - 16^{\circ}\text{C}} = \frac{47.369\text{kW} - y_1}{47.369\text{kW} - 45.422\text{kW}}$$

$$\Rightarrow y_2 = 46.515 \text{ kW}$$

*This is due to 2 different conditions with same WB temperature, will have the same level of enthalpy.

For more details, please refer to psychrometrics chart

7 Capacity tables

7 - 1 Cooling capacity tables

2nd Step:

To obtain the Total capacity and Sensible capacity for

(a) Indoor Condition: 23°C DB, 15°C WB

Outdoor Condition: 35°C DB

Indoor DB °C	Indoor WB °C	Outdoor DB°C	
		35	
		TC(kW)	SC(kW)
		!	!
20	15	64.922	35.494
23	15	--- -- -- --	x_3 y_3
24	15	64.922	50.644

Total capacity, Q

⇒ $x_3 = 64.922$ kW (Same as total capacity at 20°C Indoor DB / 15°C Indoor WB & 35°C Outdoor WB)*

Sensible capacity, Q

Extrapolation method:

$$\Rightarrow \frac{24^\circ\text{C} - 20^\circ\text{C}}{24^\circ\text{C} - 23^\circ\text{C}} = \frac{50.644\text{kW} - 35.494\text{kW}}{50.644\text{kW} - y_3}$$

⇒ $y_3 = 46.857$ kW

(b) Indoor Condition: 23°C DB, 15°C WB

Outdoor Condition: 40°C DB

Indoor DB °C	Indoor WB °C	Outdoor DB°C	
		40	
		TC(kW)	SC(kW)
		!	!
20	15	59.831	31.365
23	15	--- -- -- --	x_4 y_4
24	15	59.831	46.515

Total capacity, Q

⇒ $x_4 = 59.831$ kW (Same as total capacity at 20°C Indoor DB / 15°C Indoor WB & 40°C Outdoor WB)*

Sensible capacity, SC

Extrapolation method:

$$\Rightarrow \frac{24^\circ\text{C} - 20^\circ\text{C}}{24^\circ\text{C} - 23^\circ\text{C}} = \frac{46.515\text{kW} - 31.365\text{kW}}{46.515\text{kW} - y_4}$$

⇒ $y_4 = 42.728$ kW

*This is due to 2 different conditions with same WB temperature, will have the same level of enthalpy.

For more details, please refer to psychrometrics chart

7 Capacity tables

7 - 1 Cooling capacity tables

3rd Step:

To obtain the Total capacity and Sensible capacity for

(a) Indoor Condition: 23°C DB, 15°C WB

Outdoor Condition: 37°C DB

Indoor DB °C	Indoor WB °C	Outdoor DB°C					
		35		37		40	
		TC(kW)	SC(kW)	TC(kW)	SC(kW)	TC(kW)	SC(kW)
23	15	64.922	46.857	x	y	59.831	42.728

Total capacity, Q

Interpolation method:

$$\Rightarrow \frac{40^{\circ}\text{C} - 35^{\circ}\text{C}}{40^{\circ}\text{C} - 37^{\circ}\text{C}} = \frac{59.831\text{kW} - 64.922\text{kW}}{59.831\text{kW} - x}$$

$$\Rightarrow y = 62.886 \text{ kW}$$

Sensible capacity, SC

Interpolation method:

$$\Rightarrow \frac{40^{\circ}\text{C} - 35^{\circ}\text{C}}{40^{\circ}\text{C} - 37^{\circ}\text{C}} = \frac{42.728\text{kW} - 46.857\text{kW}}{42.728\text{kW} - y}$$

$$\Rightarrow y = 45.205 \text{ kW}$$

7 Capacity tables

7 - 1 Cooling capacity tables

UATP180AY1

COOLING MODE

ID DB°C	ID WB°C	Outdoor DB°C											
		20		25		30		35		40		46	
		TC(kW)	SC(kW)	TC(kW)	SC(kW)	TC(kW)	SC(kW)	TC(kW)	SC(kW)	TC(kW)	SC(kW)	TC(kW)	SC(kW)
20	15	17.777	11.021	16.766	10.257	15.754	9.493	14.743	8.729	13.732	7.965	12.518	7.048
	16	18.848	10.334	17.673	9.631	16.497	8.928	15.322	8.225	14.147	7.523	12.737	6.679
24	16	18.848	13.213	17.673	12.510	16.497	11.807	15.322	11.104	14.147	10.402	12.737	9.558
	17	19.918	12.526	18.579	11.884	17.241	11.242	15.902	10.601	14.563	9.959	12.956	9.189
	18	20.989	11.838	19.486	11.258	17.984	10.677	16.481	10.097	14.978	9.516	13.175	8.820
	19	22.059	11.151	20.393	10.632	18.727	10.112	17.060	9.593	15.394	9.074	13.394	8.450
	20	23.137	10.461	21.366	9.981	19.595	9.501	17.823	9.021	16.052	8.542	13.927	7.966
28	18	20.989	14.717	19.486	14.137	17.984	13.556	16.481	12.976	14.978	12.395	13.175	11.699
	19	22.059	14.030	20.393	13.511	18.727	12.991	17.060	12.472	15.394	11.953	13.394	11.330
	20	23.137	13.340	21.366	12.860	19.595	12.380	17.823	11.901	16.052	11.421	13.927	10.845
	21	24.219	12.648	22.383	12.194	20.546	11.739	18.709	11.284	16.873	10.829	14.669	10.283
	22	25.302	11.957	23.399	11.527	21.497	11.097	19.595	10.667	17.693	10.237	15.411	9.721
	23	26.384	11.265	24.416	10.860	22.449	10.455	20.481	10.051	18.513	9.646	16.152	9.160
30	24	27.466	10.574	25.433	10.194	23.400	9.814	21.367	9.434	19.334	9.054	16.894	8.598
	20	23.137	14.780	21.366	14.300	19.595	13.820	17.823	13.340	16.052	12.860	13.927	12.284
	21	24.219	14.088	22.383	13.633	20.546	13.178	18.709	12.723	16.873	12.269	14.669	11.723
	22	25.302	13.396	23.399	12.967	21.497	12.537	19.595	12.107	17.693	11.677	15.411	11.161
	23	26.384	12.705	24.416	12.300	22.449	11.895	20.481	11.490	18.513	11.085	16.152	10.599
	24	27.466	12.013	25.433	11.633	23.400	11.253	21.367	10.873	19.334	10.494	16.894	10.038

UATP240AY1

COOLING MODE

ID DB°C	ID WB°C	Outdoor DB°C											
		20		25		30		35		40		46	
		TC(kW)	SC(kW)	TC(kW)	SC(kW)	TC(kW)	SC(kW)	TC(kW)	SC(kW)	TC(kW)	SC(kW)	TC(kW)	SC(kW)
20	15	21.239	10.801	20.058	9.824	18.876	8.847	17.695	7.870	16.514	6.893	15.097	5.720
	16	22.927	10.517	21.441	9.421	19.955	8.324	18.470	7.228	16.984	6.132	15.201	4.817
24	16	22.927	15.453	21.441	14.357	19.955	13.261	18.470	12.165	16.984	11.069	15.201	9.753
	17	24.615	15.169	22.825	13.954	21.034	12.739	19.244	11.523	17.453	10.308	15.305	8.850
	18	26.304	14.885	24.208	13.551	22.113	12.216	20.018	10.882	17.923	9.548	15.409	7.946
	19	27.992	14.601	25.592	13.148	23.192	11.694	20.792	10.241	18.392	8.787	15.513	7.043
	20	29.694	14.326	27.101	12.831	24.509	11.335	21.917	9.840	19.325	8.344	16.215	6.550
28	18	26.304	19.822	24.208	18.487	22.113	17.153	20.018	15.818	17.923	14.484	15.409	12.883
	19	27.992	19.538	25.592	18.084	23.192	16.631	20.792	15.177	18.392	13.724	15.513	11.979
	20	29.694	19.263	27.101	17.767	24.509	16.272	21.917	14.776	19.325	13.281	16.215	11.486
	21	31.404	18.994	28.695	17.508	25.985	16.022	23.276	14.536	20.566	13.049	17.315	11.266
	22	33.115	18.726	30.288	17.249	27.461	15.772	24.635	14.295	21.808	12.818	18.416	11.046
	23	34.826	18.457	31.882	16.990	28.937	15.522	25.993	14.055	23.049	12.587	19.516	10.826
30	24	36.537	18.188	33.475	16.730	30.414	15.272	27.352	13.814	24.290	12.356	20.617	10.606
	20	29.694	21.731	27.101	20.235	24.509	18.740	21.917	17.244	19.325	15.749	16.215	13.954
	21	31.404	21.462	28.695	19.976	25.985	18.490	23.276	17.004	20.566	15.518	17.315	13.734
	22	33.115	21.194	30.288	19.717	27.461	18.240	24.635	16.763	21.808	15.286	18.416	13.514
	23	34.826	20.925	31.882	19.458	28.937	17.990	25.993	16.523	23.049	15.055	19.516	13.294
	24	36.537	20.657	33.475	19.198	30.414	17.740	27.352	16.282	24.290	14.824	20.617	13.074

7 Capacity tables

7 - 1 Cooling capacity tables

1
7

UATP280AY1

COOLING MODE

ID DB°C	ID WB°C	Outdoor DB°C											
		20		25		30		35		40		46	
		TC(kW)	SC(kW)	TC(kW)	SC(kW)	TC(kW)	SC(kW)	TC(kW)	SC(kW)	TC(kW)	SC(kW)	TC(kW)	SC(kW)
20	15	30.082	18.358	28.158	16.600	26.234	14.842	24.310	13.084	22.386	11.325	20.078	9.216
	16	31.597	17.965	29.436	16.120	27.274	14.276	25.113	12.431	22.952	10.586	20.358	8.373
24	16	31.597	23.712	29.436	21.867	27.274	20.022	25.113	18.178	22.952	16.333	20.358	14.119
	17	33.111	23.319	30.713	21.388	28.314	19.456	25.916	17.525	23.518	15.594	20.639	13.277
	18	34.626	22.926	31.990	20.908	29.355	18.890	26.719	16.873	24.083	14.855	20.920	12.434
	19	36.140	22.533	33.268	20.428	30.395	18.324	27.522	16.220	24.649	14.116	21.201	11.591
	20	37.669	22.146	34.671	20.008	31.674	17.870	28.676	15.732	25.679	13.595	22.082	11.029
28	18	34.626	28.672	31.990	26.655	29.355	24.637	26.719	22.619	24.083	20.602	20.920	18.180
	19	36.140	28.279	33.268	26.175	30.395	24.071	27.522	21.967	24.649	19.863	21.201	17.338
	20	37.669	27.893	34.671	25.755	31.674	23.617	28.676	21.479	25.679	19.341	22.082	16.776
	21	39.206	27.510	36.159	25.374	33.112	23.238	30.065	21.101	27.018	18.965	23.362	16.401
	22	40.743	27.128	37.646	24.993	34.550	22.858	31.454	20.723	28.358	18.589	24.642	16.027
	23	42.280	26.745	39.134	24.612	35.989	22.479	32.843	20.346	29.697	18.212	25.922	15.653
30	24	43.817	26.363	40.622	24.231	37.427	22.099	34.232	19.968	31.037	17.836	27.203	15.278
	20	37.669	30.766	34.671	28.628	31.674	26.490	28.676	24.352	25.679	22.215	22.082	19.649
	21	39.206	30.383	36.159	28.247	33.112	26.111	30.065	23.975	27.018	21.838	23.362	19.275
	22	40.743	30.001	37.646	27.866	34.550	25.731	31.454	23.597	28.358	21.462	24.642	18.900
	23	42.280	29.618	39.134	27.485	35.989	25.352	32.843	23.219	29.697	21.086	25.922	18.526
24	43.817	29.236	40.622	27.104	37.427	24.973	34.232	22.841	31.037	20.709	27.203	18.152	

UATP320AY1

COOLING MODE

ID DB°C	ID WB°C	Outdoor DB°C											
		20		25		30		35		40		46	
		TC(kW)	SC(kW)	TC(kW)	SC(kW)	TC(kW)	SC(kW)	TC(kW)	SC(kW)	TC(kW)	SC(kW)	TC(kW)	SC(kW)
20	15	36.003	21.212	33.488	19.288	30.973	17.363	28.458	15.439	25.943	13.515	22.925	11.206
	16	37.990	19.736	35.099	17.973	32.208	16.209	29.317	14.446	26.427	12.683	22.958	10.567
24	16	37.990	26.292	35.099	24.529	32.208	22.765	29.317	21.002	26.427	19.239	22.958	17.123
	17	39.977	24.816	36.710	23.214	33.443	21.612	30.177	20.009	26.910	18.407	22.990	16.484
	18	41.964	23.340	38.321	21.899	34.679	20.458	31.036	19.016	27.393	17.575	23.022	15.846
	19	43.951	21.864	39.932	20.584	35.914	19.304	31.895	18.023	27.877	16.743	23.055	15.207
	20	45.962	20.384	41.771	19.227	37.580	18.070	33.388	16.913	29.197	15.757	24.167	14.368
28	18	41.964	29.896	38.321	28.455	34.679	27.014	31.036	25.572	27.393	24.131	23.022	22.402
	19	43.951	28.420	39.932	27.140	35.914	25.860	31.895	24.579	27.877	23.299	23.055	21.763
	20	45.962	26.940	41.771	25.783	37.580	24.626	33.388	23.469	29.197	22.313	24.167	20.925
	21	47.990	25.456	43.761	24.398	39.532	23.339	35.303	22.281	31.074	21.223	26.000	19.953
	22	50.018	23.973	45.751	23.013	41.485	22.053	37.219	21.093	32.952	20.133	27.832	18.981
	23	52.045	22.489	47.741	21.628	43.438	20.766	39.134	19.905	34.830	19.043	29.665	18.009
30	24	54.073	21.006	49.732	20.243	45.390	19.479	41.049	18.716	36.707	17.953	31.498	17.038
	20	45.962	30.218	41.771	29.061	37.580	27.904	33.388	26.747	29.197	25.591	24.203	24.203
	21	47.990	28.734	43.761	27.676	39.532	26.617	35.303	25.559	31.074	24.501	26.000	23.231
	22	50.018	27.251	45.751	26.291	41.485	25.331	37.219	24.371	32.952	23.411	27.832	22.259
	23	52.045	25.767	47.741	24.906	43.438	24.044	39.134	23.183	34.830	22.321	29.665	21.287
24	54.073	24.284	49.732	23.521	45.390	22.757	41.049	21.994	36.707	21.231	31.498	20.316	

7 Capacity tables

7 - 1 Cooling capacity tables

UATP450AY1

COOLING MODE

ID DB°C	ID WB°C	Outdoor DB°C											
		20		25		30		35		40		46	
		TC(kW)	SC(kW)	TC(kW)	SC(kW)	TC(kW)	SC(kW)	TC(kW)	SC(kW)	TC(kW)	SC(kW)	TC(kW)	SC(kW)
20	15	47.660	30.236	44.240	26.821	40.819	23.407	37.399	19.992	33.979	16.577	29.875	12.480
	16	48.482	28.579	45.052	25.159	41.622	21.739	38.192	18.320	34.761	14.900	30.645	10.796
24	16	48.482	37.353	45.052	33.933	41.622	30.513	38.192	27.094	34.761	23.674	30.645	19.570
	17	49.305	35.696	45.865	32.271	42.424	28.846	38.984	25.421	35.543	21.996	31.415	17.886
	18	50.128	34.040	46.677	30.609	43.227	27.179	39.776	23.749	36.325	20.319	32.185	16.202
	19	50.950	32.383	47.490	28.948	44.029	25.512	40.568	22.077	37.107	18.641	32.955	14.518
	20	51.782	30.745	48.389	27.463	44.995	24.180	41.601	20.898	38.207	17.615	34.134	13.676
28	18	50.128	42.814	46.677	39.384	43.227	35.953	39.776	32.523	36.325	29.093	32.185	24.976
	19	50.950	41.157	47.490	37.722	44.029	34.286	40.568	30.851	37.107	27.415	32.955	23.292
	20	51.782	39.519	48.389	36.237	44.995	32.954	41.601	29.672	38.207	26.389	34.134	22.450
	21	52.621	37.894	49.345	34.870	46.069	31.846	42.793	28.822	39.518	25.798	35.587	22.169
	22	53.459	36.269	50.301	33.504	47.144	30.738	43.986	27.973	40.828	25.207	37.039	21.889
	23	54.297	34.644	51.257	32.137	48.218	29.630	45.179	27.123	42.139	24.616	38.492	21.608
	24	55.135	33.019	52.214	30.771	49.293	28.522	46.371	26.274	43.450	24.025	39.945	21.327
30	20	51.782	43.906	48.389	40.624	44.995	37.341	41.601	34.059	38.207	30.776	34.134	26.837
	21	52.621	42.281	49.345	39.257	46.069	36.233	42.793	33.209	39.518	30.185	35.587	26.556
	22	53.459	40.656	50.301	37.891	47.144	35.125	43.986	32.360	40.828	29.594	37.039	26.276
	23	54.297	39.031	51.257	36.524	48.218	34.017	45.179	31.510	42.139	29.003	38.492	25.995
	24	55.135	37.406	52.214	35.158	49.293	32.909	46.371	30.661	43.450	28.412	39.945	25.714

UATP560AY1

COOLING MODE

ID DB°C	ID WB°C	Outdoor DB°C											
		20		25		30		35		40		46	
		TC(kW)	SC(kW)	TC(kW)	SC(kW)	TC(kW)	SC(kW)	TC(kW)	SC(kW)	TC(kW)	SC(kW)	TC(kW)	SC(kW)
20	15	56.583	34.633	53.494	32.278	50.406	29.923	47.317	27.569	44.228	25.214	40.522	22.389
	16	59.858	32.697	56.311	30.552	52.765	28.407	49.219	26.262	45.673	24.118	41.417	21.544
24	16	59.858	42.380	56.311	40.235	52.765	38.090	49.219	35.945	45.673	33.800	41.417	31.227
	17	63.133	40.444	59.129	38.509	55.125	36.574	51.121	34.639	47.117	32.704	42.312	30.382
	18	66.407	38.508	61.946	36.783	57.484	35.057	53.023	33.332	48.562	31.607	43.208	29.537
	19	69.682	36.572	64.763	35.057	59.844	33.541	54.925	32.026	50.006	30.510	44.103	28.692
	20	72.974	34.620	67.740	33.185	62.506	31.750	57.273	30.315	52.039	28.879	45.758	27.157
28	18	66.407	48.191	61.946	46.465	57.484	44.740	53.023	43.015	48.562	41.290	43.208	39.220
	19	69.682	46.255	64.763	44.739	59.844	43.224	54.925	41.708	50.006	40.193	44.103	38.375
	20	72.974	44.303	67.740	42.868	62.506	41.433	57.273	39.997	52.039	38.562	45.758	36.840
	21	76.277	42.341	70.824	40.900	65.371	39.458	59.917	38.017	54.464	36.575	47.920	34.845
	22	79.581	40.380	73.908	38.932	68.235	37.484	62.562	36.036	56.889	34.588	50.082	32.851
	23	82.884	38.418	76.992	36.964	71.099	35.509	65.207	34.055	59.314	32.601	52.243	30.856
	24	86.187	36.456	80.075	34.996	73.963	33.535	67.851	32.074	61.739	30.614	54.405	28.861
30	20	72.974	49.145	67.740	47.709	62.506	46.274	57.273	44.839	52.039	43.404	45.758	41.681
	21	76.277	47.183	70.824	45.741	65.371	44.300	59.917	42.858	54.464	41.416	47.920	39.687
	22	79.581	45.221	73.908	43.773	68.235	42.325	62.562	40.877	56.889	39.429	50.082	37.692
	23	82.884	43.259	76.992	41.805	71.099	40.351	65.207	38.897	59.314	37.442	52.243	35.697
	24	86.187	41.297	80.075	39.837	73.963	38.376	67.851	36.916	61.739	35.455	54.405	33.703

7 Capacity tables

7 - 1 Cooling capacity tables

1
7

UATP700AY1

COOLING MODE

ID DB°C	ID WB°C	Outdoor DB°C											
		20		25		30		35		40		46	
		TC(kW)	SC(kW)	TC(kW)	SC(kW)	TC(kW)	SC(kW)	TC(kW)	SC(kW)	TC(kW)	SC(kW)	TC(kW)	SC(kW)
20	15	73.780	42.021	69.096	38.222	64.412	34.423	59.729	30.624	55.045	26.825	49.424	22.267
	16	75.967	38.405	71.136	35.264	66.305	32.122	61.474	28.980	56.643	25.839	50.846	22.069
24	16	75.967	53.555	71.136	50.414	66.305	47.272	61.474	44.130	56.643	40.988	50.846	37.218
	17	78.154	49.940	73.176	47.455	68.198	44.971	63.220	42.486	58.242	40.002	52.268	37.020
	18	80.341	46.324	75.216	44.497	70.091	42.670	64.965	40.842	59.840	39.015	53.690	36.822
	19	82.529	42.709	77.256	41.539	71.983	40.369	66.711	39.199	61.438	38.028	55.111	36.624
	20	84.727	39.056	79.396	38.227	74.065	37.397	68.735	36.568	63.404	35.739	57.008	34.744
28	18	80.341	61.474	75.216	59.647	70.091	57.820	64.965	55.992	59.840	54.165	53.690	51.972
	19	82.529	57.859	77.256	56.689	71.983	55.519	66.711	54.348	61.438	53.178	55.111	51.774
	20	84.727	54.205	79.396	53.376	74.065	52.547	68.735	51.718	63.404	50.889	57.008	49.894
	21	86.932	50.527	81.602	49.828	76.273	49.129	70.944	48.431	65.615	47.732	59.220	46.893
	22	89.137	46.848	83.809	46.280	78.481	45.711	73.154	45.143	67.826	44.574	61.433	43.892
	23	91.342	43.169	86.016	42.731	80.689	42.293	75.363	41.855	70.037	41.417	63.646	40.891
30	24	93.547	39.491	88.222	39.183	82.897	38.875	77.573	38.567	72.248	38.260	65.859	37.890
	20	84.727	61.780	79.396	60.951	74.065	60.122	68.735	59.293	63.404	58.464	57.469	57.469
	21	86.932	58.102	81.602	57.403	76.273	56.704	70.944	56.005	65.615	55.307	59.220	54.468
	22	89.137	54.423	83.809	53.855	78.481	53.286	73.154	52.718	67.826	52.149	61.433	51.467
30	23	91.342	50.744	86.016	50.306	80.689	49.868	75.363	49.430	70.037	48.992	63.646	48.466
	24	93.547	47.066	88.222	46.758	82.897	46.450	77.573	46.142	72.248	45.835	65.859	45.465

UATP850AY1

COOLING MODE

ID DB°C	ID WB°C	Outdoor DB°C											
		20		25		30		35		40		46	
		TC(kW)	SC(kW)	TC(kW)	SC(kW)	TC(kW)	SC(kW)	TC(kW)	SC(kW)	TC(kW)	SC(kW)	TC(kW)	SC(kW)
20	15	93.421	56.330	87.291	50.822	81.160	45.315	75.030	39.808	68.900	34.301	61.543	27.692
	16	94.381	51.720	88.530	47.059	82.679	42.397	76.828	37.736	70.977	33.074	63.956	27.481
24	16	94.381	70.207	88.530	65.546	82.679	60.884	76.828	56.223	70.977	51.561	63.956	45.967
	17	95.342	65.598	89.770	61.782	84.198	57.966	78.627	54.151	73.055	50.335	66.369	45.756
	18	96.302	60.988	91.009	58.019	85.717	55.049	80.425	52.079	75.133	49.109	68.782	45.545
	19	97.262	56.379	92.249	54.255	87.236	52.131	82.223	50.007	77.210	47.883	71.195	45.334
	20	98.216	51.726	93.428	50.078	88.639	48.430	83.851	46.782	79.063	45.134	73.318	43.156
28	18	96.302	79.475	91.009	76.505	85.717	73.535	80.425	70.565	75.133	67.596	68.782	64.032
	19	97.262	74.866	92.249	72.742	87.236	70.618	82.223	68.494	77.210	66.370	71.195	63.821
	20	98.216	70.212	93.428	68.564	88.639	66.916	83.851	65.268	79.063	63.620	73.318	61.643
	21	99.165	65.529	94.565	64.111	89.966	62.693	85.366	61.274	80.766	59.856	75.247	58.154
	22	100.114	60.846	95.703	59.657	91.292	58.469	86.881	57.280	82.470	56.092	77.176	54.666
	23	101.063	56.163	96.841	55.204	92.618	54.245	88.395	53.286	84.173	52.327	79.106	51.177
30	24	102.013	51.479	97.979	50.750	93.944	50.021	89.910	49.292	85.876	48.563	81.035	47.688
	20	98.216	79.456	93.428	77.808	88.639	76.160	83.851	74.512	79.063	72.864	73.318	70.886
	21	99.165	74.772	94.565	73.354	89.966	71.936	85.366	70.518	80.766	69.099	75.247	67.398
	22	100.114	70.089	95.703	68.901	91.292	67.712	86.881	66.524	82.470	65.335	77.176	63.909
30	23	101.063	65.406	96.841	64.447	92.618	63.488	88.395	62.529	84.173	61.571	79.106	60.420
	24	102.013	60.723	97.979	59.994	93.944	59.265	89.910	58.535	85.876	57.806	81.035	56.931

7 Capacity tables

7 - 1 Cooling capacity tables

UATPC10AY1

COOLING MODE

ID DB°C	ID WB°C	Outdoor DB°C											
		20		25		30		35		40		46	
		TC(kW)	SC(kW)	TC(kW)	SC(kW)	TC(kW)	SC(kW)	TC(kW)	SC(kW)	TC(kW)	SC(kW)	TC(kW)	SC(kW)
20	15	113.782	73.870	106.055	66.180	98.329	58.490	90.602	50.800	82.876	43.109	73.604	33.881
	16	114.260	69.578	107.014	62.403	99.768	55.228	92.523	48.053	85.277	40.878	76.582	32.268
24	16	114.260	90.286	107.014	83.111	99.768	75.936	92.523	68.761	85.277	61.586	76.582	52.976
	17	114.738	85.993	107.973	79.334	101.208	72.674	94.443	66.014	87.679	59.355	79.561	51.363
	18	115.216	81.701	108.932	75.556	102.648	69.412	96.364	63.268	90.080	57.123	82.539	49.750
	19	115.694	77.408	109.891	71.779	104.088	66.150	98.285	60.521	92.481	54.892	85.518	48.137
28	20	116.162	73.102	110.750	67.880	105.339	62.657	99.927	57.435	94.516	52.213	88.022	45.946
	18	115.216	102.409	108.932	96.264	102.648	90.120	96.364	83.976	90.080	77.831	82.539	70.458
	19	115.694	98.116	109.891	92.487	104.088	86.858	98.285	81.229	92.481	75.600	85.518	68.845
	20	116.162	93.810	110.750	88.588	105.339	83.366	99.927	78.143	94.516	72.921	88.022	66.654
	21	116.622	89.496	111.543	84.608	106.464	79.720	101.384	74.831	96.305	69.943	90.210	64.077
	22	117.082	85.182	112.335	80.628	107.589	76.074	102.842	71.520	98.095	66.966	92.398	61.501
30	23	117.543	80.867	113.128	76.648	108.713	72.428	104.299	68.208	99.884	63.988	94.586	58.925
	24	118.003	76.553	113.921	72.667	109.838	68.782	105.756	64.897	101.674	61.011	96.775	56.349
	20	116.162	104.164	110.750	98.942	105.339	93.720	99.927	88.497	94.516	83.275	88.022	77.008
	21	116.622	99.850	111.543	94.962	106.464	90.074	101.384	85.186	96.305	80.297	90.210	74.432
30	22	117.082	95.536	112.335	90.982	107.589	86.428	102.842	81.874	98.095	77.320	92.398	71.855
	23	117.543	91.221	113.128	87.002	108.713	82.782	104.299	78.562	99.884	74.343	94.586	69.279
	24	118.003	86.907	113.921	83.021	109.838	79.136	105.756	75.251	101.674	71.365	96.775	66.703

UATPC12AY1

COOLING MODE

ID DB°C	ID WB°C	Outdoor DB°C											
		20		25		30		35		40		46	
		TC(kW)	SC(kW)	TC(kW)	SC(kW)	TC(kW)	SC(kW)	TC(kW)	SC(kW)	TC(kW)	SC(kW)	TC(kW)	SC(kW)
20	15	142.536	91.485	132.349	82.271	122.162	73.056	111.974	63.842	101.787	54.627	89.562	43.570
	16	147.379	86.805	136.503	77.788	125.627	68.771	114.751	59.754	103.874	50.737	90.823	39.916
24	16	147.379	111.046	136.503	102.028	125.627	93.011	114.751	83.994	103.874	74.977	90.823	64.157
	17	152.222	106.365	140.657	97.546	129.092	88.726	117.527	79.906	105.962	71.087	92.084	60.503
	18	157.065	101.685	144.811	93.063	132.557	84.440	120.303	75.818	108.049	67.196	93.345	56.849
	19	161.908	97.005	148.965	88.580	136.022	80.155	123.080	71.730	110.137	63.305	94.606	53.195
28	20	166.811	92.346	153.680	84.294	140.549	76.242	127.418	68.189	114.287	60.137	98.530	50.475
	18	157.065	125.926	144.811	117.304	132.557	108.681	120.303	100.059	108.049	91.437	93.345	81.090
	19	161.908	121.246	148.965	112.821	136.022	104.396	123.080	95.971	110.137	87.546	94.606	77.436
	20	166.811	116.586	153.680	108.534	140.549	100.482	127.418	92.430	114.287	84.378	98.530	74.716
	21	171.754	111.941	158.769	104.379	145.784	96.817	132.799	89.255	119.813	81.692	104.231	72.618
	22	176.697	107.296	163.857	100.224	151.018	93.151	138.179	86.079	125.339	79.007	109.932	70.520
30	23	181.640	102.651	168.946	96.068	156.253	89.486	143.559	82.903	130.865	76.321	115.633	68.422
	24	186.583	98.006	174.035	91.913	161.487	85.820	148.939	79.728	136.391	73.635	121.334	66.323
	20	166.811	128.707	153.680	120.655	140.549	112.603	127.418	104.551	114.287	96.499	98.530	86.836
	21	171.754	124.062	158.769	116.499	145.784	108.937	132.799	101.375	119.813	93.813	104.231	84.738
30	22	176.697	119.416	163.857	112.344	151.018	105.272	138.179	98.199	125.339	91.127	109.932	82.640
	23	181.640	114.771	168.946	108.189	156.253	101.606	143.559	95.024	130.865	88.441	115.633	80.542
	24	186.583	110.126	174.035	104.033	161.487	97.941	148.939	91.848	136.391	85.755	121.334	78.444

8 Dimensional drawing & centre of gravity

8 - 1 Dimensional drawing

UATP180AY1

(unit: mm)

* Except: Drain size. (unit: inch)

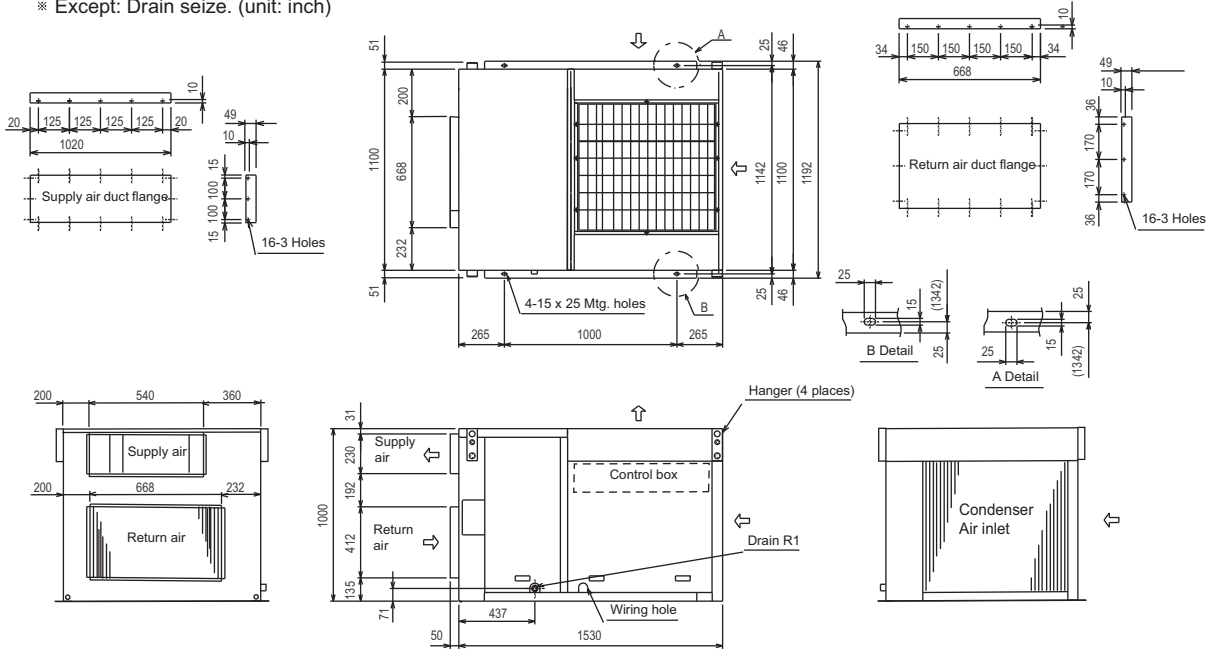

UATP240/280/320AY1

(unit: mm)

* Except: Drain size: (unit inch)

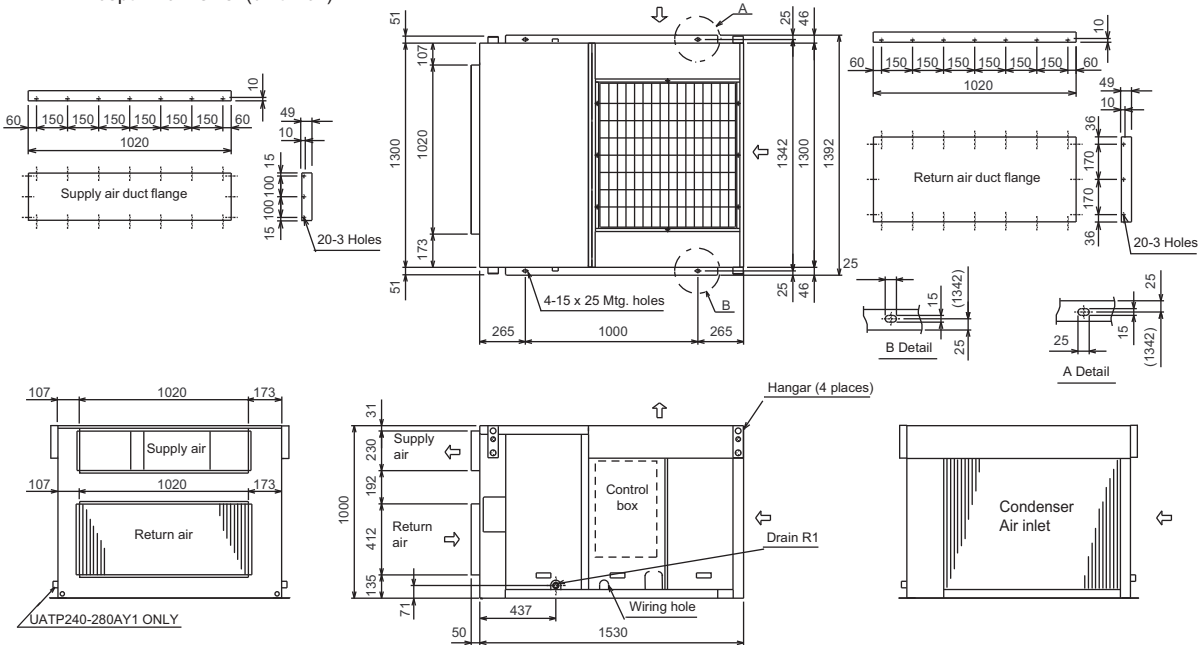

UATP240-280AY1 ONLY

8 Dimensional drawing & centre of gravity

8 - 1 Dimensional drawing

UATP450/560AY1

(unit: mm)

※ Except: Drain size: (unit inch)

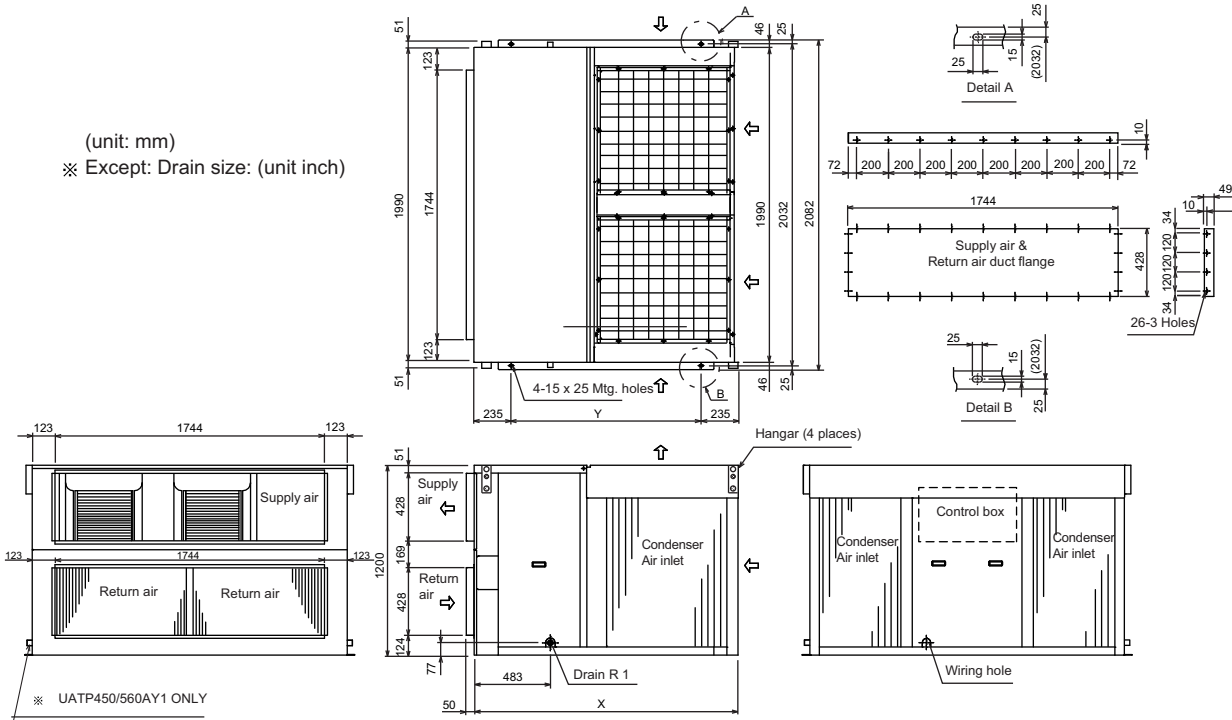

UATP700/850AY1

(unit: mm)

※ Except: Drain size: (unit inch)

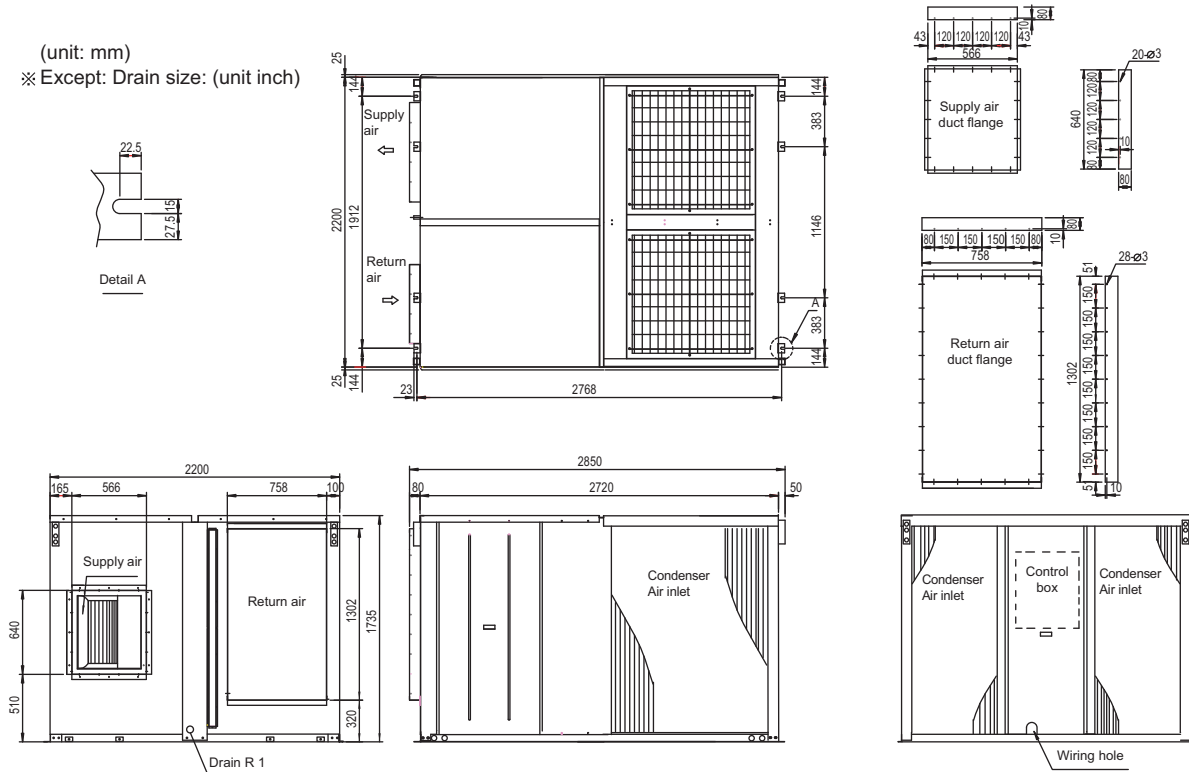

8 Dimensional drawing & centre of gravity

8 - 1 Dimensional drawing

UATP450/560AY1

(unit: mm)

※ Except: Drain size: (unit inch)

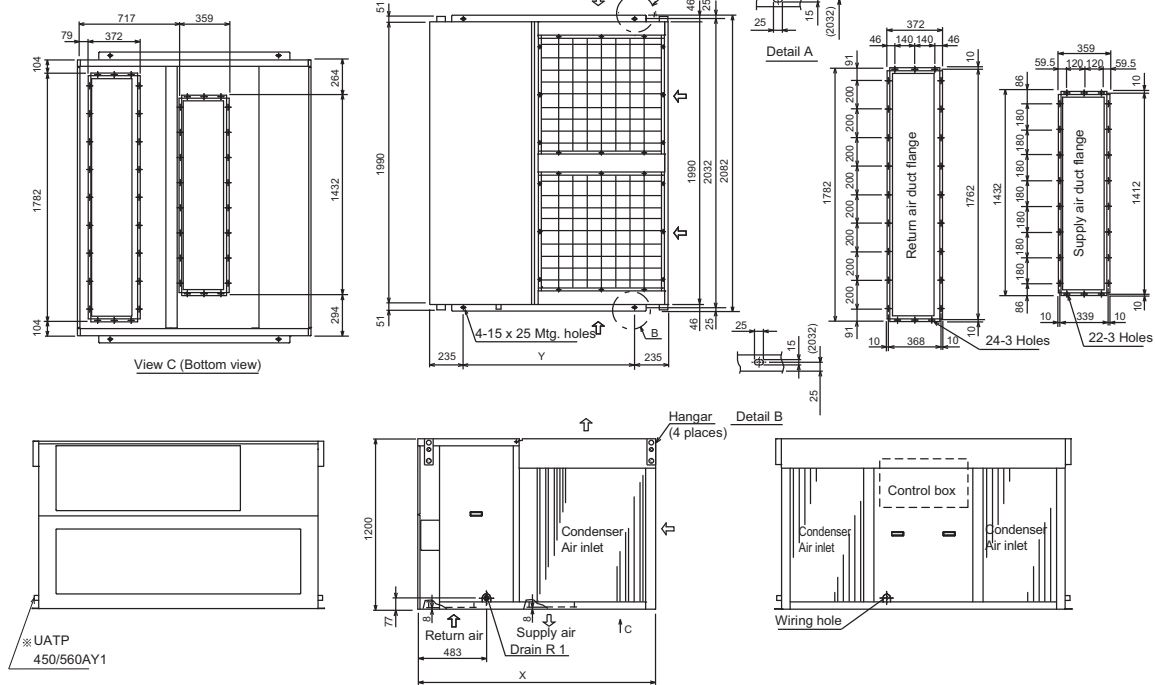

UATP700/850AY1

(unit: mm)

※ Except: Drain size: (unit inch)

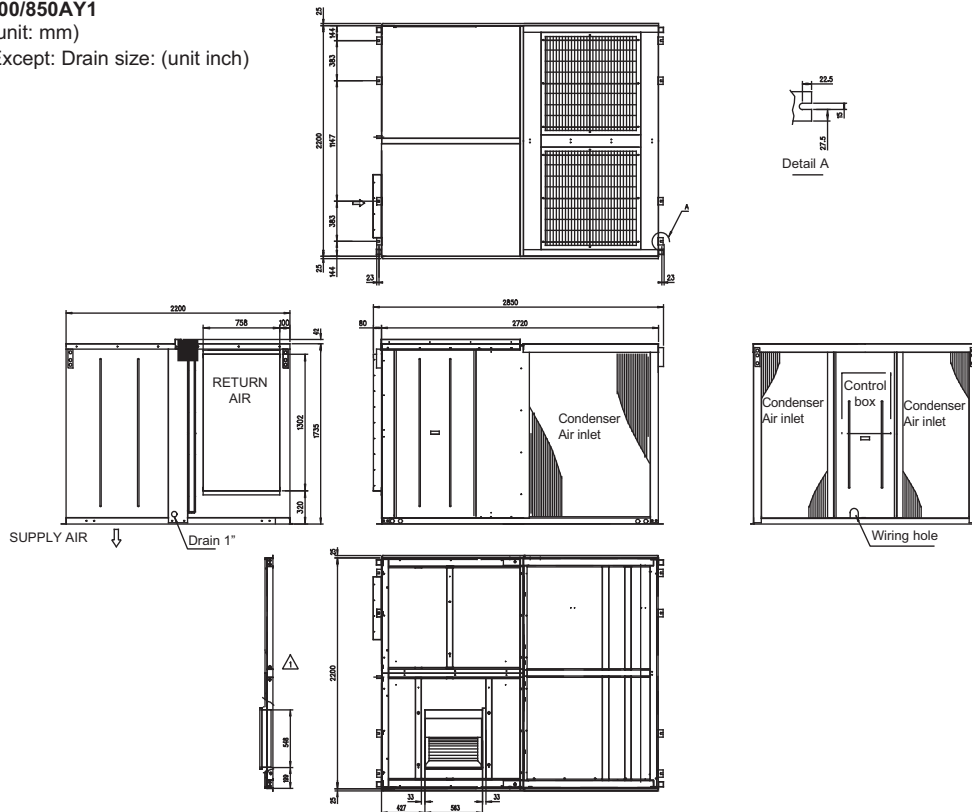

9 Piping diagram

1
9

UATP180AY1

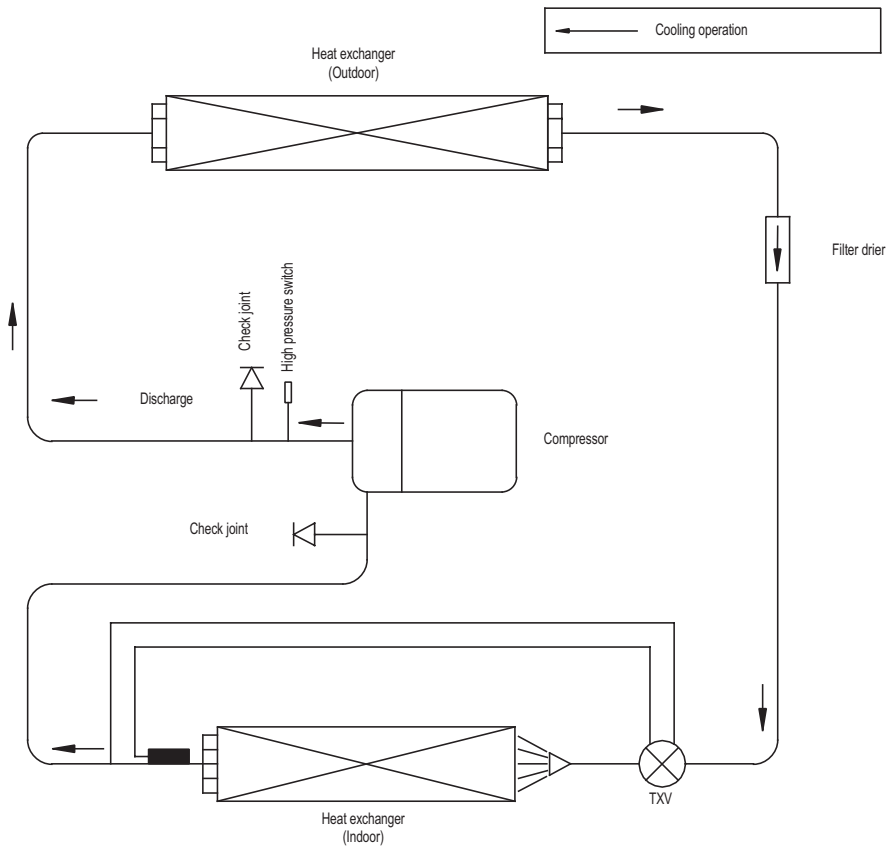

UATP240/280AY1

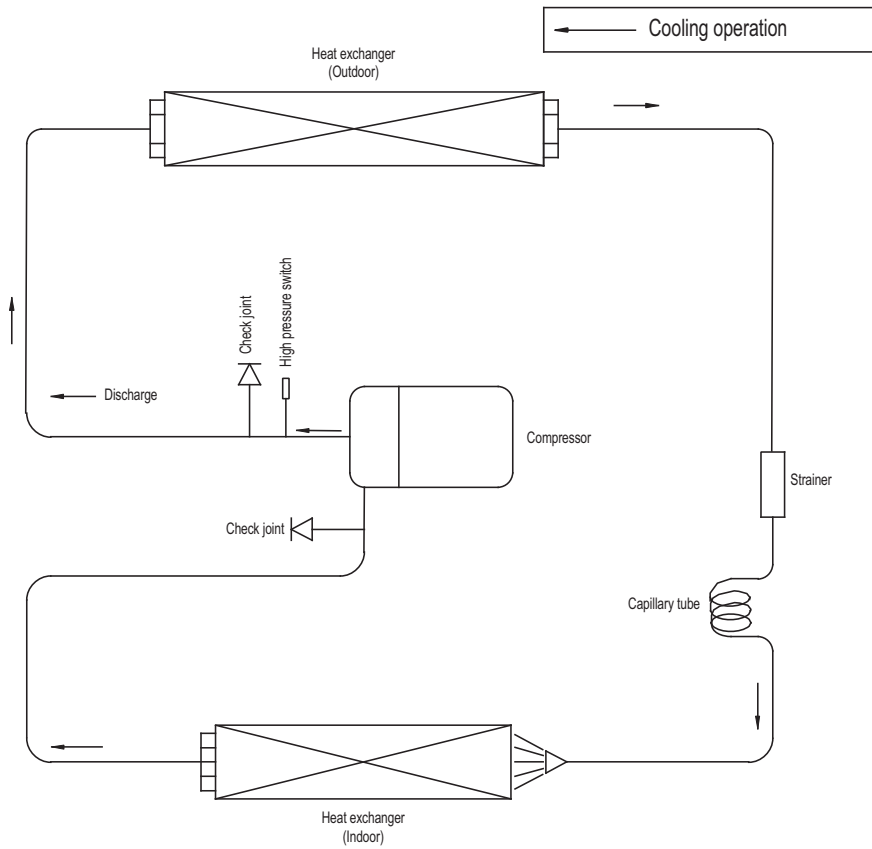

9 Piping diagram

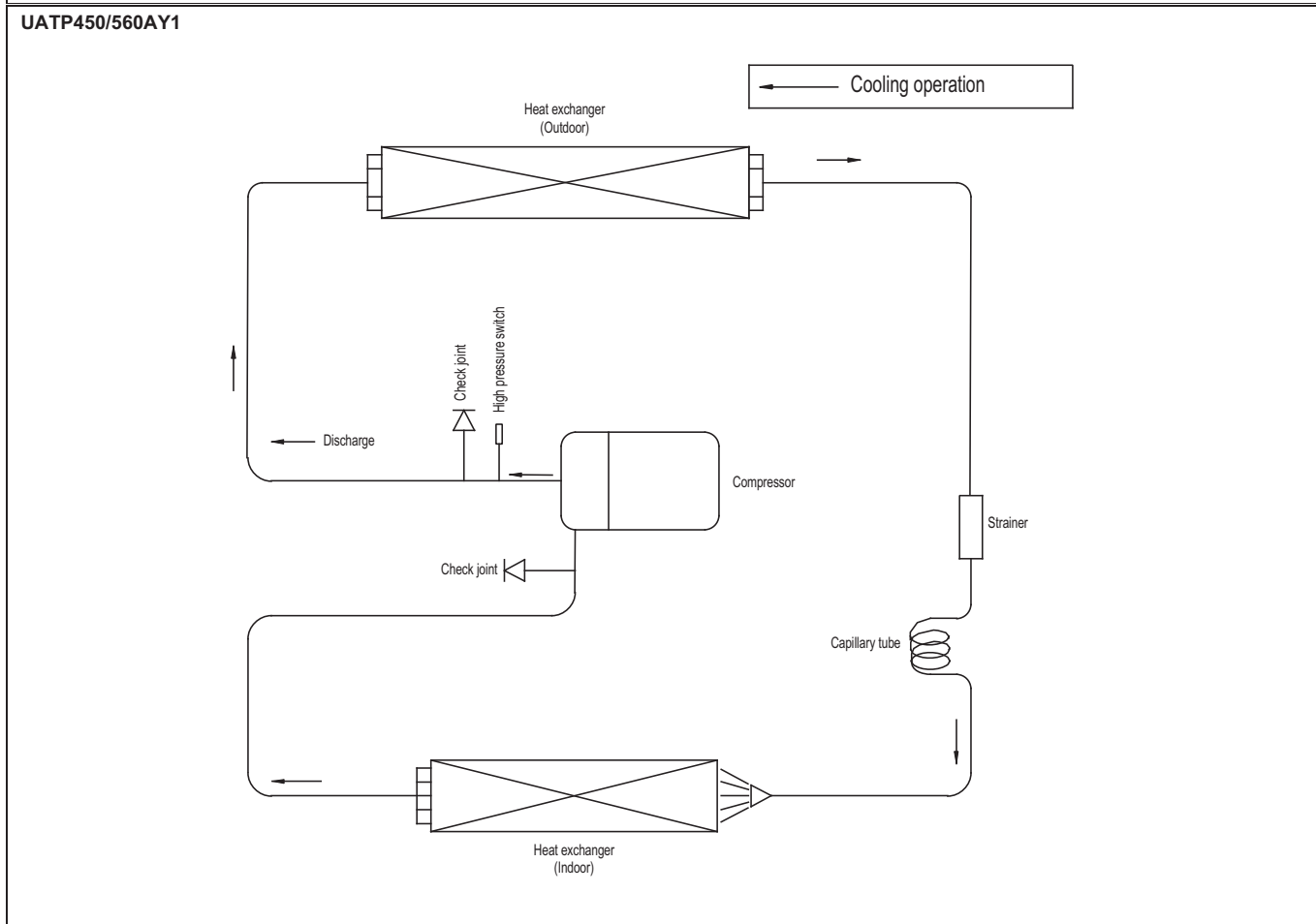
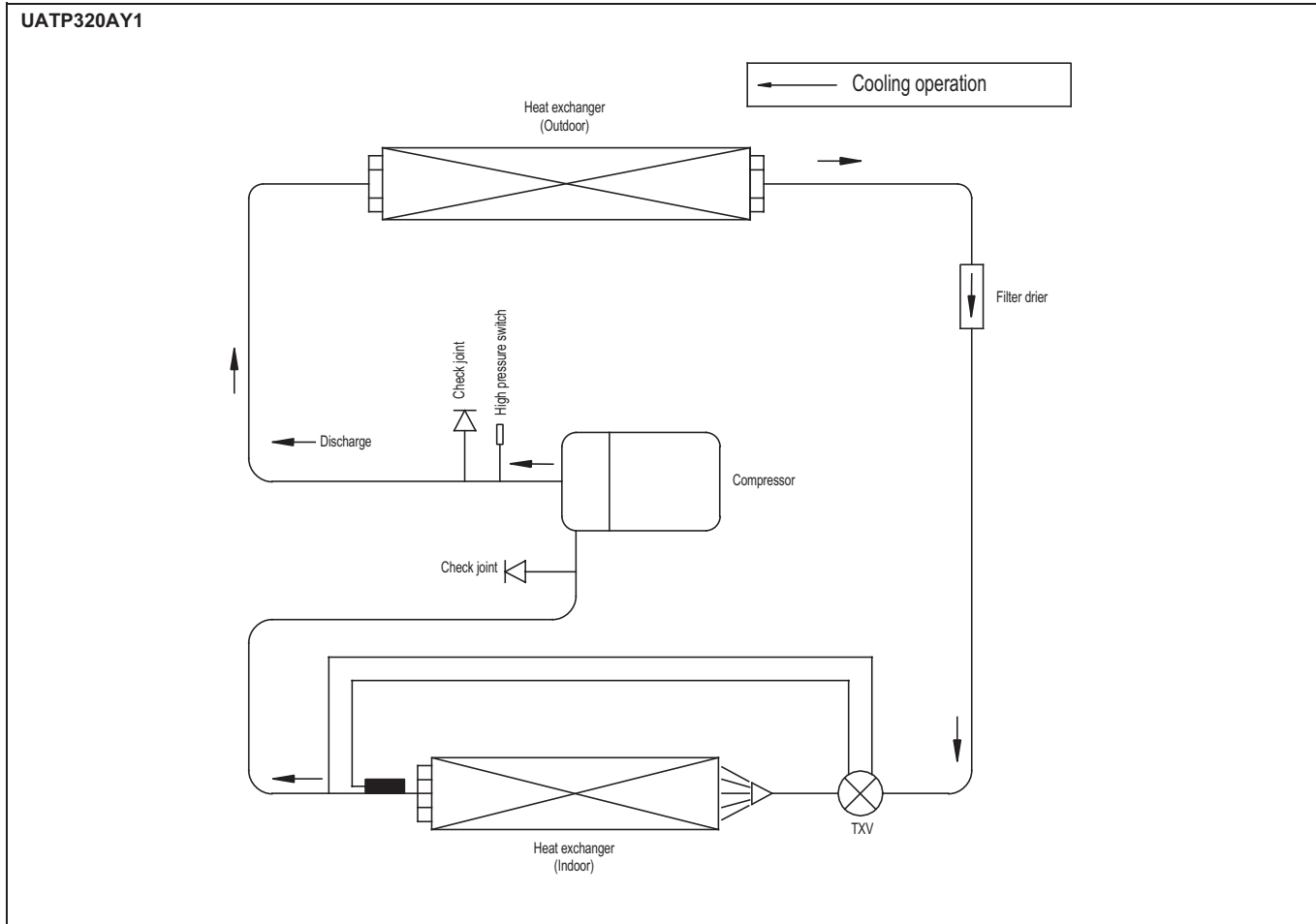

9 Piping diagram

1
9

UATP700/850AY1

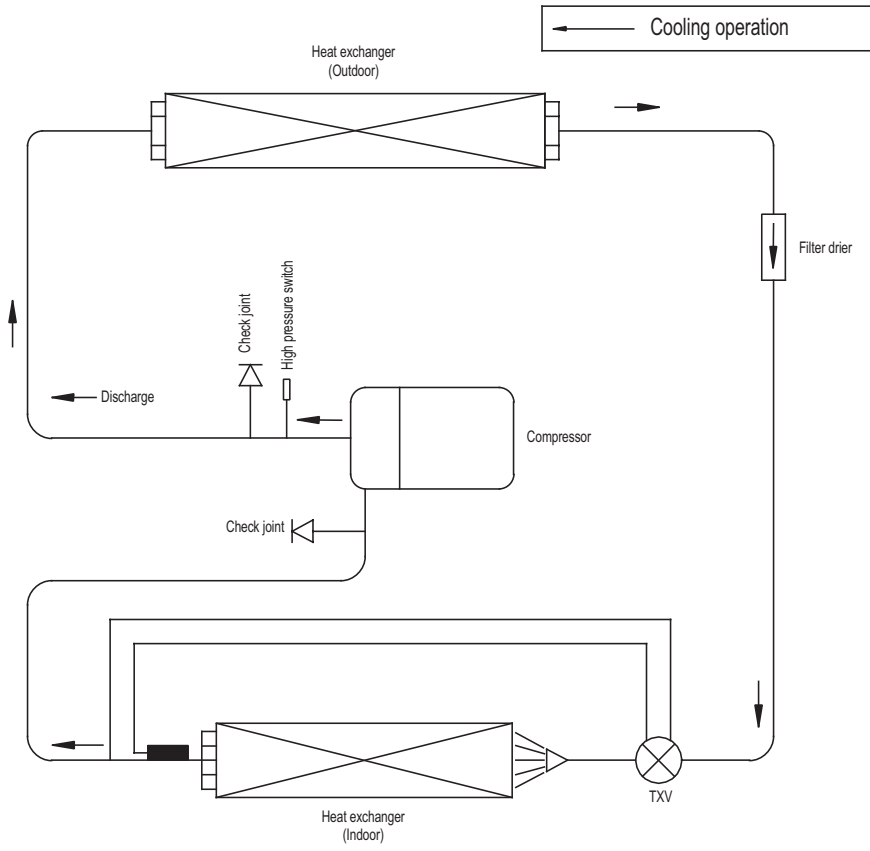

UATPC10/12AY1

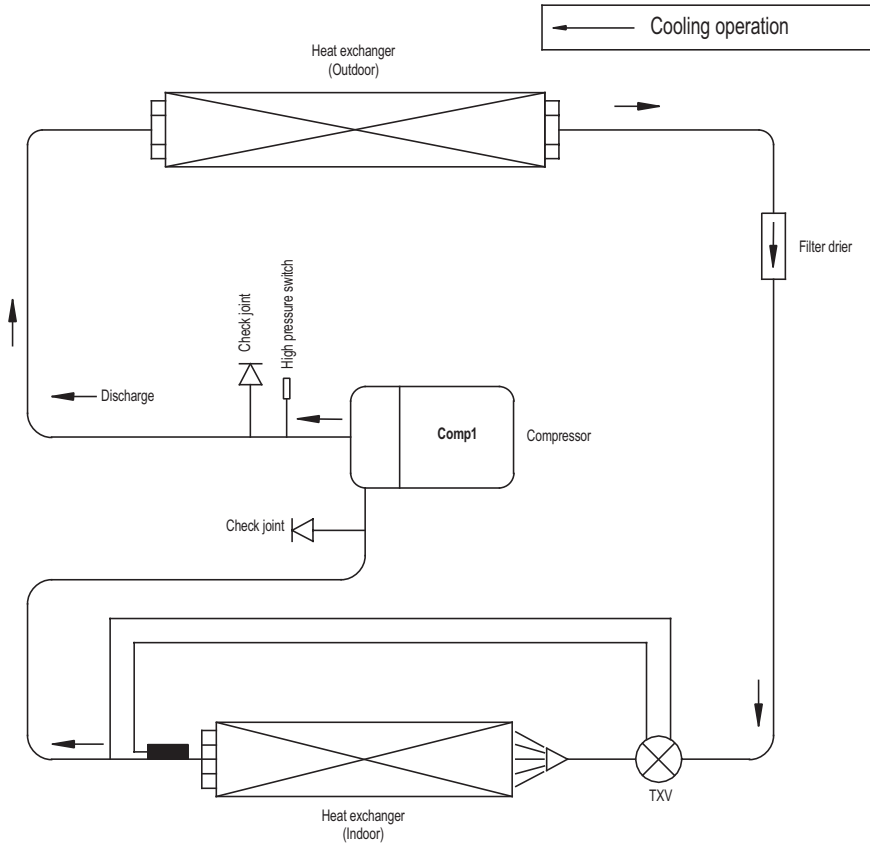

10 Wiring diagram

10 - 1 Wiring diagram

UATP180AY1

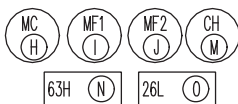
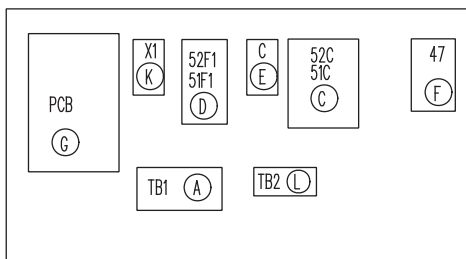
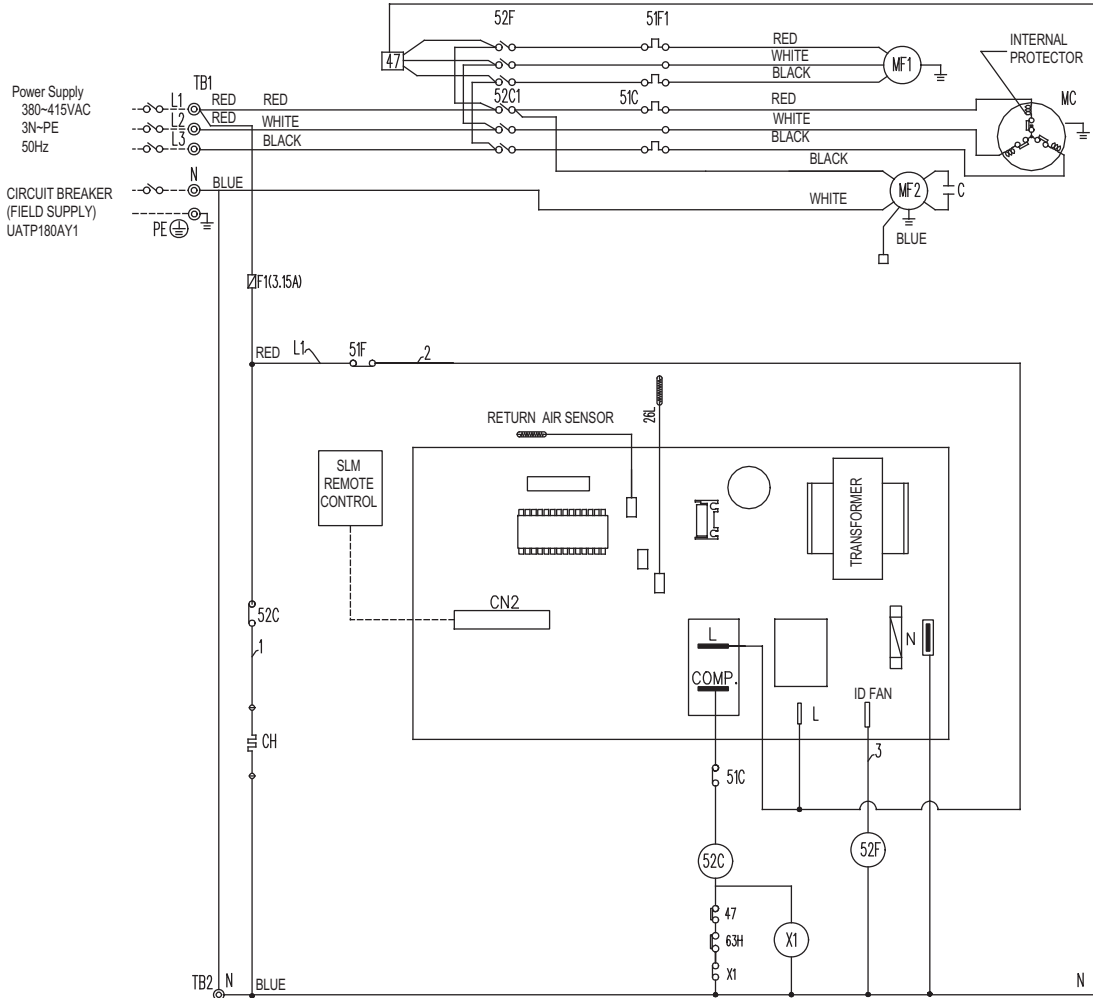

SYMBOL	NAME
MC	Compressor motor
MF1	Fan motor (indoor)
MF2	Fan motor (outdoor)
52C	Contactor (Compressor)
52F1	Contactor (fan I/D)
51C	Over current relay (comp)
C	Capacitor (o/d fan motor)
TB1,2	Terminal block
51F	Over current relay (fan I/D)
63H	High-pressure switch
CH	Crankcase heater
26L	Sensor (freeze protection)
PCB	Printed circuit board
47	Phase Protector / Discharge thermostat
X1	Auxiliary Relay (Self hold)
F1	Fuse (3.15A)

Caution,

1. To protect each Fan motor and compressor from abnormal current, Over current relays <51C>, <51F> are installed. Therefore, do not change factory set value of Over current relays.

NOTES

- The dotted lines show field wiring.
- The figure in the parenthesis shows field supply parts.
- Color of earth is yellow and green twisting.

10 Wiring diagram

10 - 1 Wiring diagram

UATP240/280/320AY1

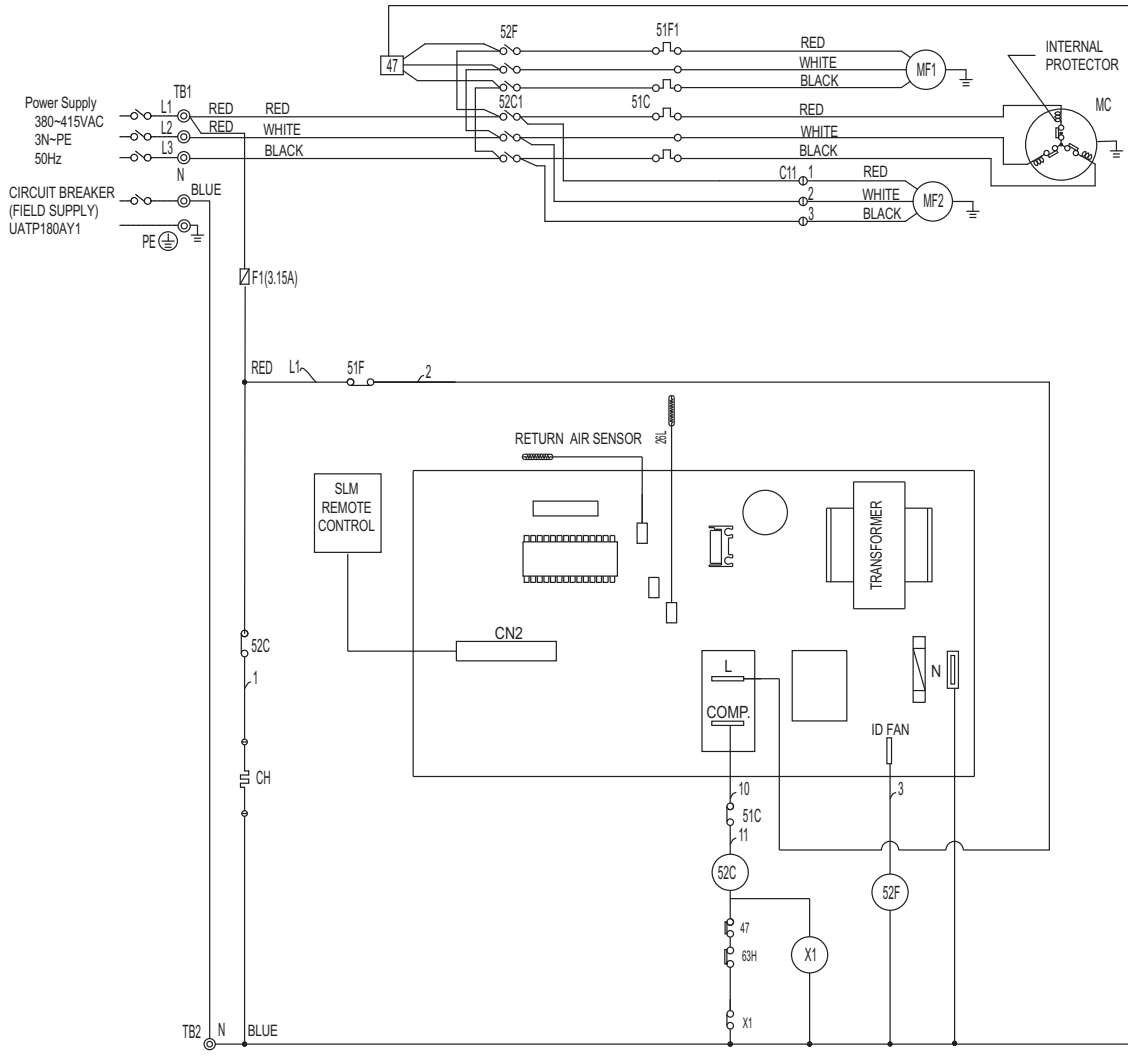

Arrangement

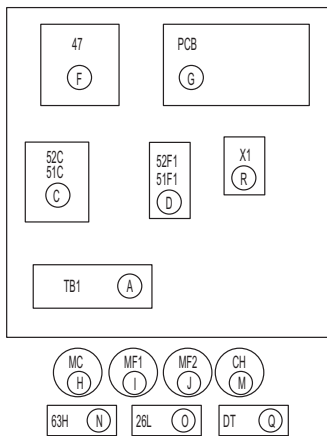

SYMBOL	NAME
MC	Compressor motor
MF1	Fan motor (indoor)
MF2	Fan motor (outdoor)
52C	Contactor (Compressor)
52F1	Contactor (fan I/D)
51C	Over current relay (comp)
TB1	Terminal block
F1	Fuse (3.15A)
51F	Over current relay (fan I/D)
63H	High-pressure switch
CH	Crankcase heater
26L	Sensor (freeze protection)
PCB	Printed circuit board
47	Phase Protector / Discharge thermostat
X1	Auxiliary Relay (Self hold)

Caution,

1. To protect each Fan motor and compressor from abnormal current, Over current relays <51C>, <51F> are installed. Therefore, do not change factory set value of Over current relays.

NOTES

- The dotted lines show field wiring.
- The figure in the parenthesis shows field supply parts.
- Color of earth is yellow and green twisting.

10 Wiring diagram

10 - 1 Wiring diagram

UATP450/560AY1

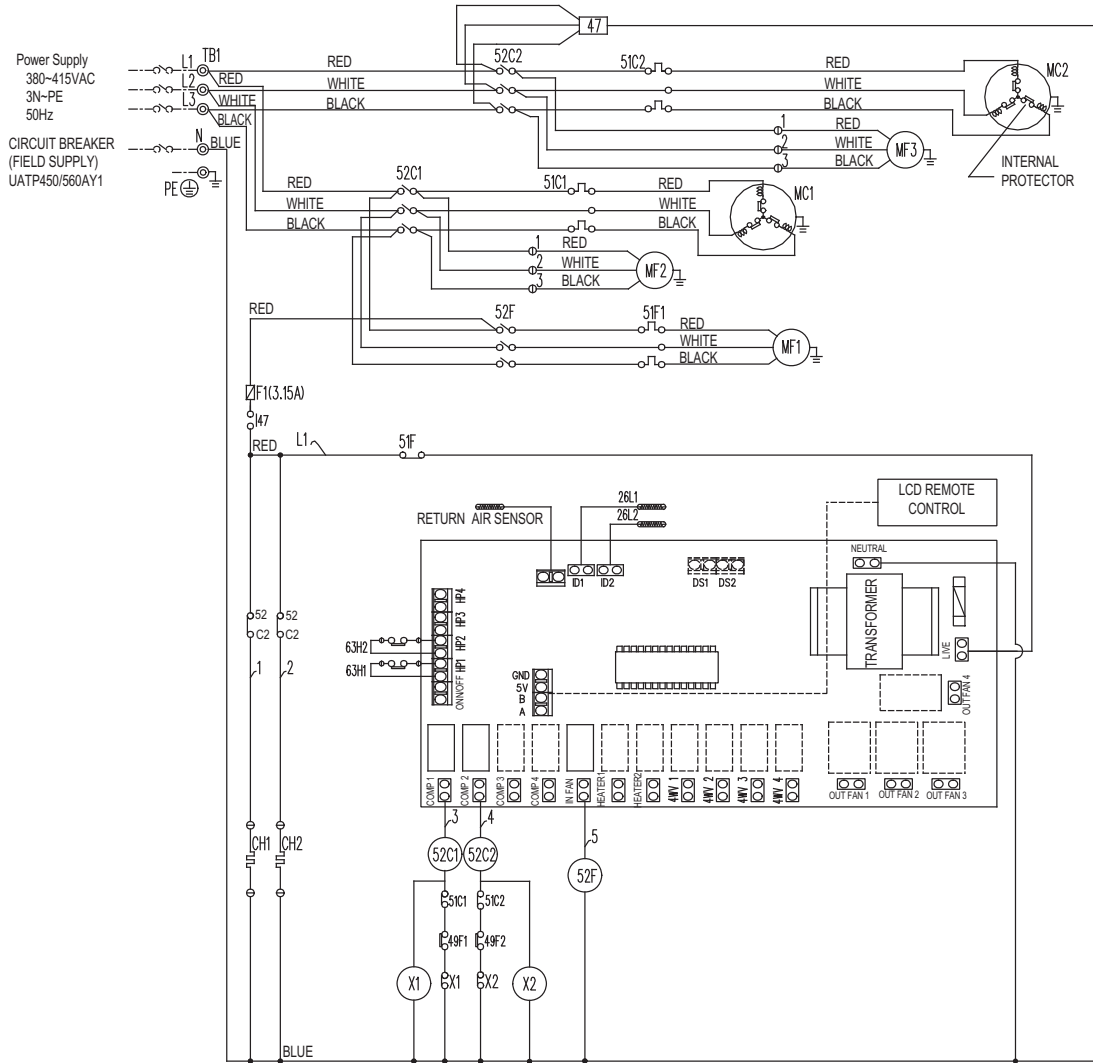

Arrangement

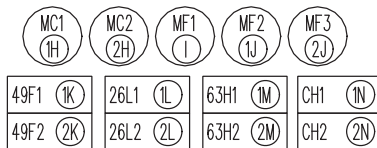
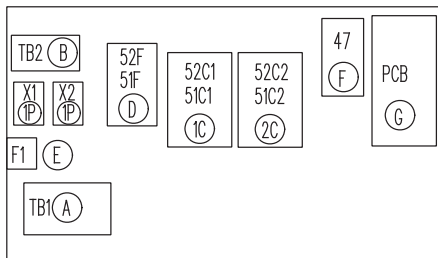

SYMBOL	NAME
MC	Compressor motor
MF1	Fan motor (indoor)
MF2,3	Fan motor (outdoor)
52C1,2	Contactora (Compressor)
52F	Contactora (fan I/D)
TB1,2	Terminal block
F1	Fuse (3.15A)
51C1,C2	Over current relay (fan I/D)
51F1	Over current relay (fan I/D)
CH1,2	Crankcase heater
26L1,2	Sensor (freeze protection)
PCB	Printed circuit board
47	Phase Protector
49F1,2	Internal protector (OD fan)
63H1,H2	High Pressure Switch
X1,2	Auxiliary Relay (Self Hold)

Caution,

1. To protect each Fan motor and compressor from abnormal current, Over current relays <51C>, <51F> are installed. Therefore, do not change factory set value of Over current relays.

NOTES

- The dotted lines show field wiring.
- The figure in the parenthesis shows field supply parts.
- Color of earth is yellow and green twisting.

10 Wiring diagram

10 - 1 Wiring diagram

1
10

UATP700/850AY1

Power Supply
380~415VAC
3N-PE
50Hz

CIRCUIT BREAKER
(FIELD SUPPLY)
UATP700/850AY1

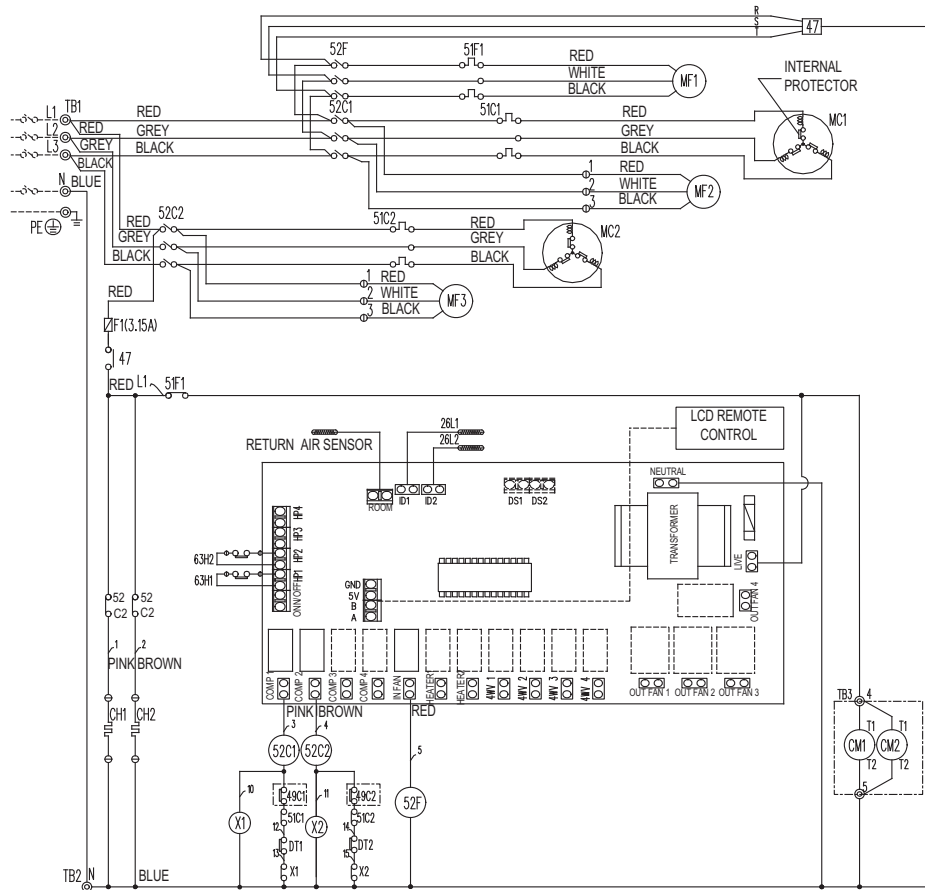

Arrangement

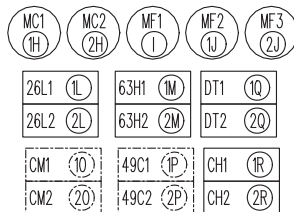
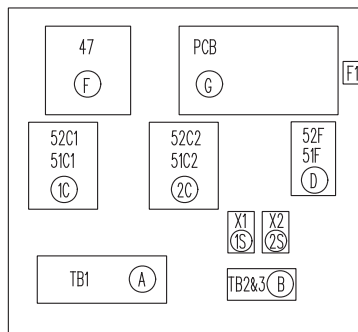

*UATP850AY1 only
*UATP850AY1 only

SYMBOL	NAME
MC1,2	Compressor motor
MF1	Fan motor (indoor)
MF2,3	Fan motor (outdoor)
52C1,2	Contactors (Compressor)
52F1	Contactors (fan I/D)
51C1,C2	Overload protector (compressor)
TB1,2,3	Terminal block
F1	Fuse (3.15A)
51F	Overload protector (fan I/D)
63H1,2	High Pressure Switch
CH1,2	Crankcase heater
26L1,2	Sensor (freeze protection)
PCB	Printed circuit board
47	Phase Protector
DT1,2	Discharged thermostat
X1,2	Auxiliary Relay (Self Hold)
49C1,C2	Compressor internal/Overload
CM1,2	Compressor Control Module

Caution,

1. To protect each Fan motor and compressor from abnormal current, Overload protectors are installed. Therefore, do not change factory set value of the overload protector.

NOTES

- The dotted lines show field wiring.
- Color of earth is yellow and green twisting.
- Each wire is addressed.
- shows wiring for model UATP850AY1
In the case of UATP700AY1: no wire connection at TB3(4) and (5), &49C is replaced by single

10 Wiring diagram

10 - 1 Wiring diagram

UATPC10/12AY1

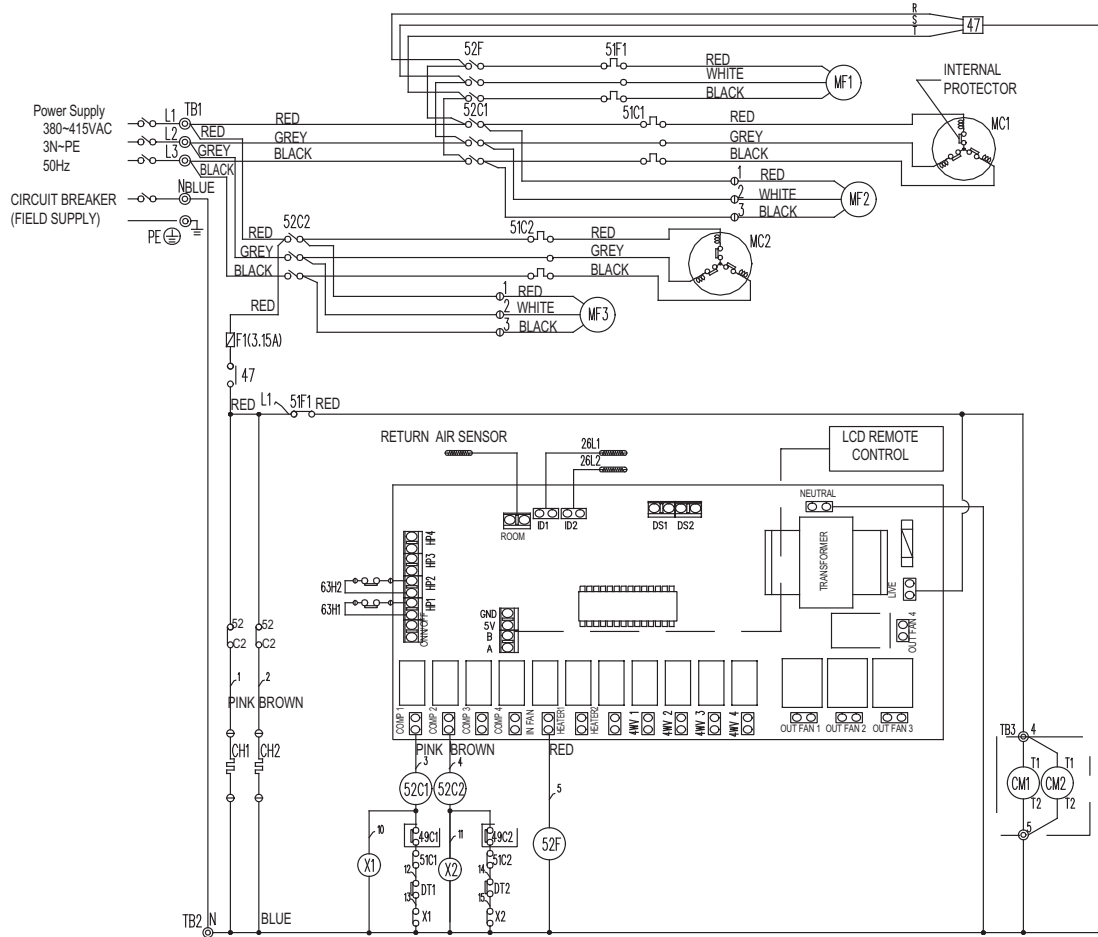

Arrangement

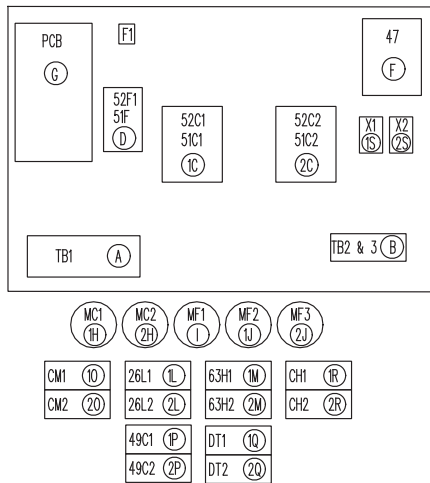

SYMBOL	NAME
MC1,2	Compressor motor
MF1	Fan motor (indoor)
MF2,3	Fan motor (outdoor)
52C1,2	Contact (Compressor)
52F1	Contact (fan I/D)
51C1,C2	Overload protector (compressor)
TB1,2,3	Terminal block
F1	Fuse (3.15A)
51F	Overload protector (fan I/D)
63H1,2	High-Pressure Switch
CH1,2	Crankcase heater
26L1,2	Sensor (freeze protection)
PCB	Printed circuit board
47	Phase Protector
DT1,2	Discharge thermostat
X1,2	Auxiliary Relay (Self Hold)
49C1,C2	Compressor internal Overload
CM1,2	Compressor Control Module

Caution,

1. To protect each Fan motor and compressor from abnormal current, Overload protectors are installed. Therefore, do not change factory set value of the overload protector.

NOTES

- The dotted lines show field wiring.
- Color of earth wire is yellow and green twisting.
- Specification subject to change without notice.
- Each wire is addressed.

11 Sound data

11 - 1 Sound pressure spectrum

1
11

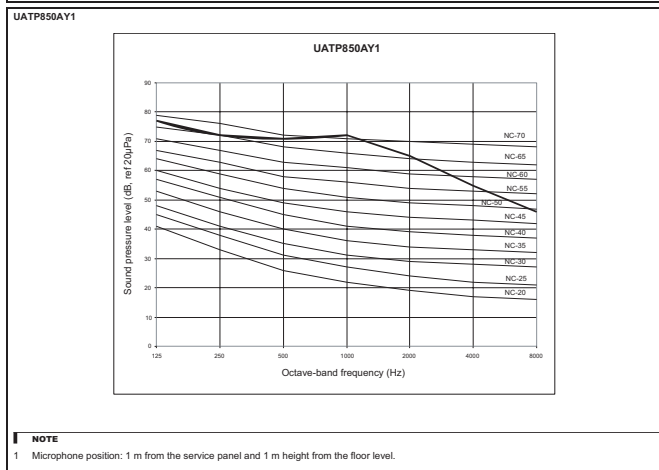
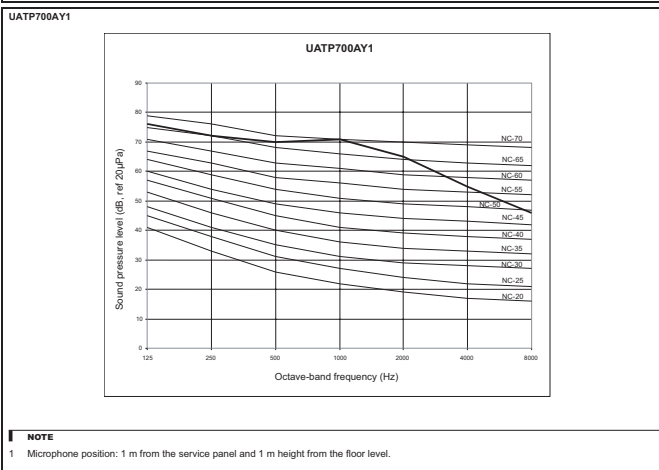
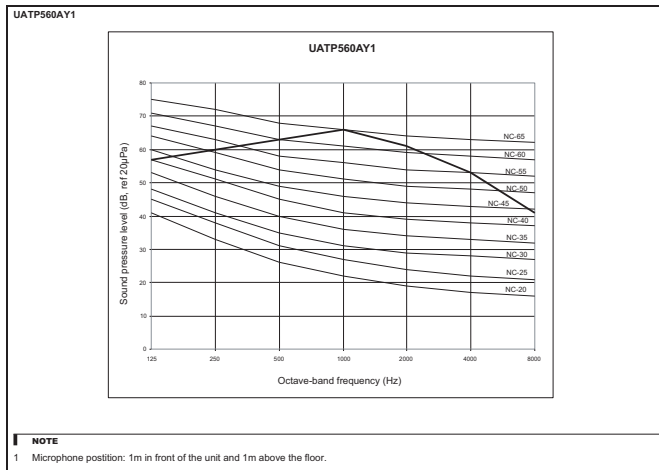
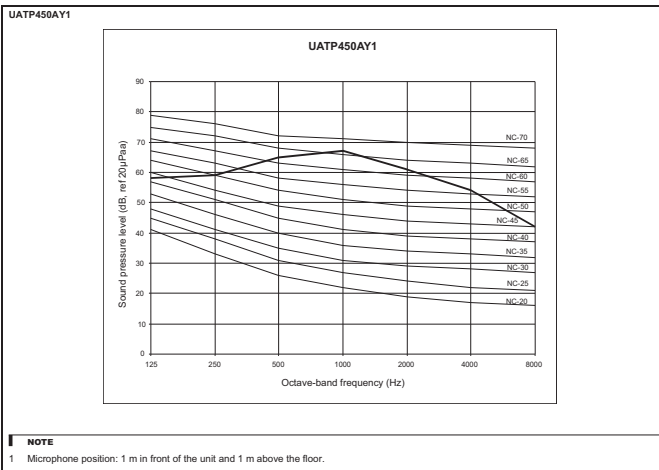
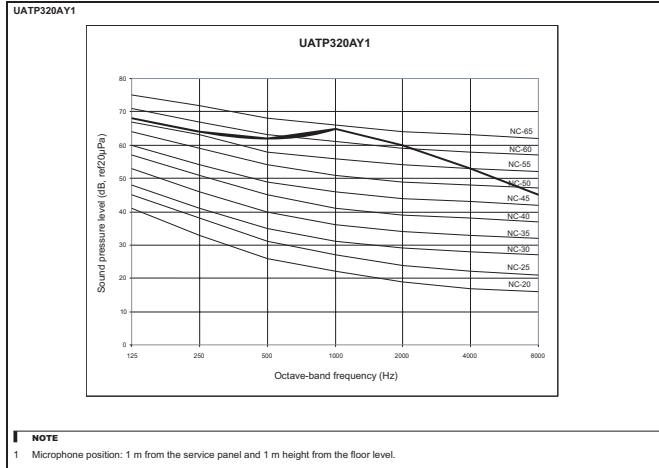
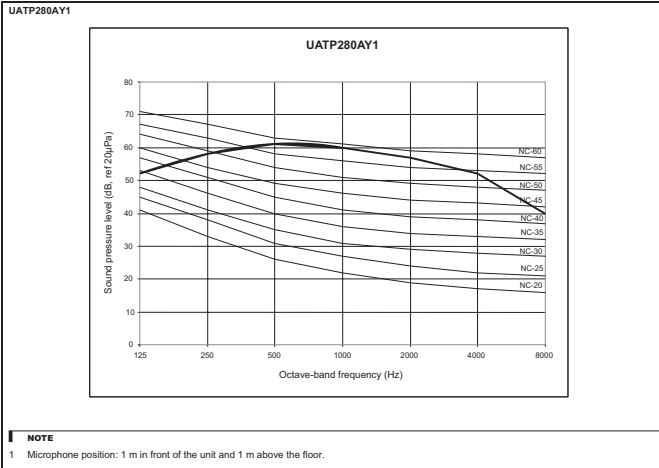
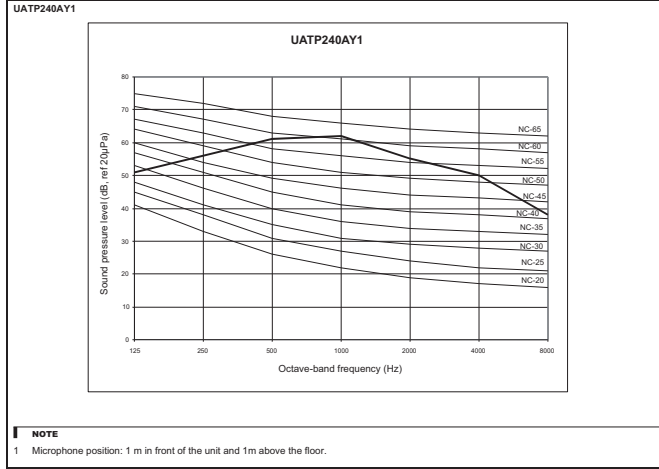
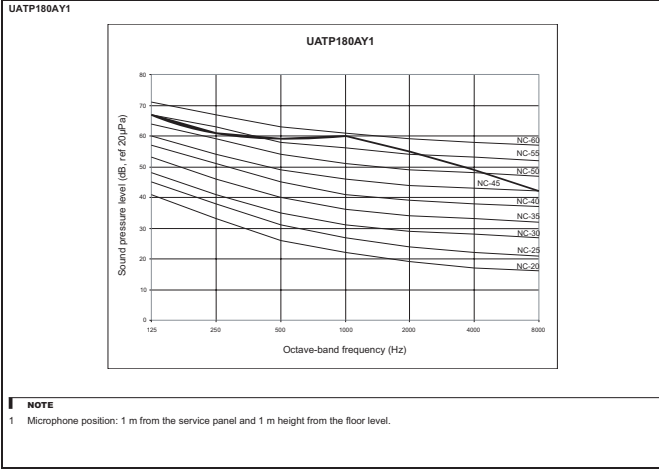

11 Sound data

11 - 1 Sound pressure spectrum

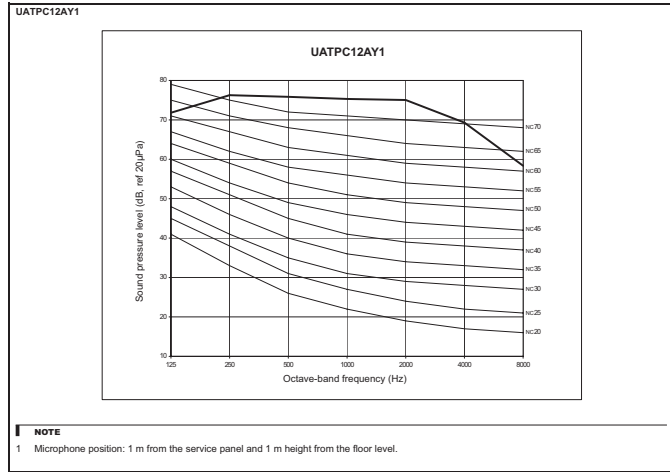
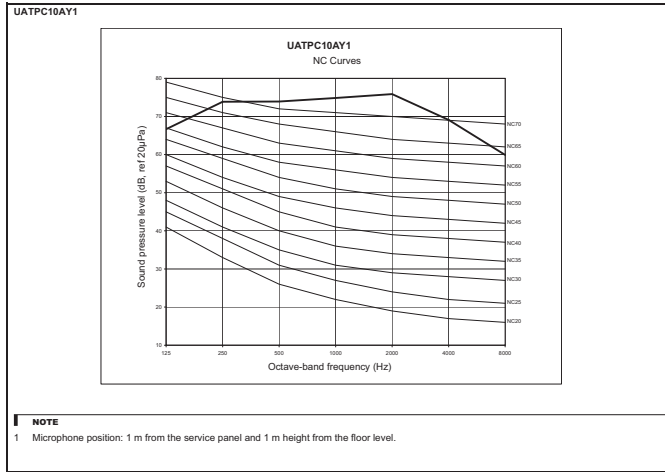

12 Fan characteristics

1
12

Selection Process

Drive Package

The following are the design requirements for UAT280AY1 unit:

Model: UAT280AY1

Supply Air Quantity = 3800 CFM
External Static Pressure = 150 Pa

Step 1: From the blower curve (at 8000 CFM), Standard operating system:
Internal Static pressure = 150 Pa

Step 2: Therefore at 3800 CFM and 150 Pa external static pressure, Total Static Pressure = 150 + 150 Pa = 300 Pa

Step 3: From the blower curve, the design requirement calls for RPM about 1200 RPM.

From the table:

Motor pulley	=	114	mm
Blower pulley	=	152	mm
Motor RPM	=	1080	

In order to obtain 1200 RPM, we calculate the new blower pulley as: (while maintaining the motor pulley)

$$Db = 114 \times (1080/1200) = 102.6 \text{ mm}$$

Let us take close approximation of 100 mm diameter pulley size

Recheck, with Db = 100mm

Blow pulley	=	1080 x (114/100)	
	=	1311.2	RPM

We thus need to change the blower pulley from 152 mm to 100 mm in order to obtain the higher operating static pressure.

Step 4: When the pulley is changed, the V-belt length must be rechecked. We have for horizontal air throw configuration:

$$V\text{-belt length, L} = 2C + 1.57(Db + Dm) = (2 \times 184) + 1.57(114 + 100) = 703.98$$

We thus can use a belt with a length of 704 mm.

where, C = distance between the centres of the two pulleys
Db = diameter of blower pulley
Dm = diameter of motor pulley

Step 5: From the blower curve, we can also notice that the motor power input has maintained within the current operating range of the standard unit's motor.

Summary:

i) Fan motor kW	=	1.5	kW
ii) Blower pulley diameter	=	100	mm
iii) V-belt size	=	704	mm

The following table summarizes the pulley data, motor size used for the UATP-series, as manufactured:

Model	Blower pulley, Db			Motor Pulley, Dm		
	Type	Diameter (mm)	Bore (mm)	Type	Diameter (mm)	Bore (mm)
UATP180A1	B1	152	20	B1	102	19
UATP240A1	B1	152	20	B1	102	24
UATP280A1	B1	152	20	B1	114	24
UATP320A1	B1	140	20	B1	114	24
UATP350A1	B2	254	28	B2	127	28
UATP500A1	B2	254	28	B2	152	28
UATP700A1	SPZ 2	224	25	SPZ 2	125	38
UATP850A1	SPZ 2	224	25	SPZ 2	140	38
UATPC10AY1	SPA	280	40	SPA	124	38
UATPC12AY1	SPA	250	40	SPA	118	38

Model	V-belt length, L (mm)	Pulley Centre Distance, C (mm)		Motor kW	Motor RPM
		Minimum	Maximum		
UATP180A1	762	180		0.75	980
UATP240A1	762	180		1.1	980
UATP280A1	797	184	126	1.5	1080
UATP320A1	762	180		1.5	1100
UATP350A1	1067	225	190	2.2	730
UATP500A1	1092	221	306	3.7	850
UATP700A1	1662	558	572	5.5	840
UATP850A1	1700	565		7.5	880
UATPC10AY1	2132	748		7.5	1440
UATPC12AY1	2060	739	730	7.5	1440

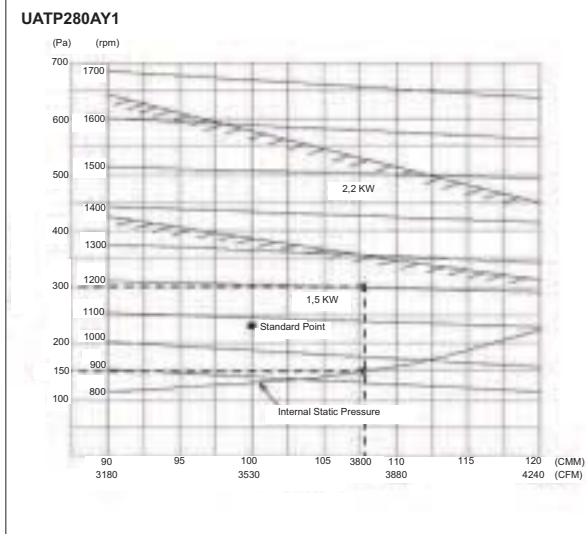

PULLEY OUTSIDE DIMENSIONS ARE SHOWN BELOW: (UNIT : MM)

(1) Shape Of Belt Groove

1.1

Shape of V-belt	Nominal Dia. ØPC	a (°)	W	Lo	K	Ko	e	f	f1	f2	f3	V-belt thickness (Reference)
B	Over 125	34	15.86	12.5	5.5	9.5	19.0	12.5	0.2-0.5	0.5-1.0	1-2	11
	Under 160											
	Over 160											
	Over 200	38	16.29									

Sectional plan of V-belt

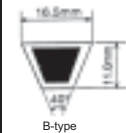

1.2 Taper lock type UATP700/850AY1

Section	Sheave dia. d2	Groove angle β	Wg	bmin	hmin	e	f
SPZ	71-80 > 80	34° 38'	8.5	2.0	9.0	12 ± 0.3	8 ± 1

Sectioned plan of V-belt

(2) Shape Of Motor Pulley Boss (unit:mm)

MOTOR CAPACITY (kW)	A	B	C
1.1, 1.5	Ø24 +0.028 +0.007	27 +0.128 +0.007	8 +0.018 -0.018
2.2, 3.7	Ø28 +0.028 +0.007	31 +0.128 +0.007	8 +0.028 -0.013
5.5, 7.5	Ø38 +0.028 +0.007	41 +0.128 +0.008	10 +0.028 -0.013

Fan Performance Curve UATP180AY1

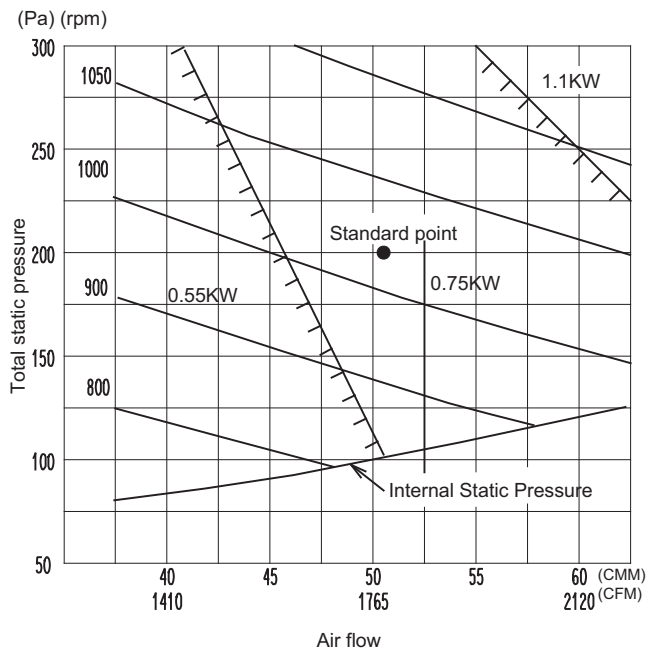

12 Fan characteristics

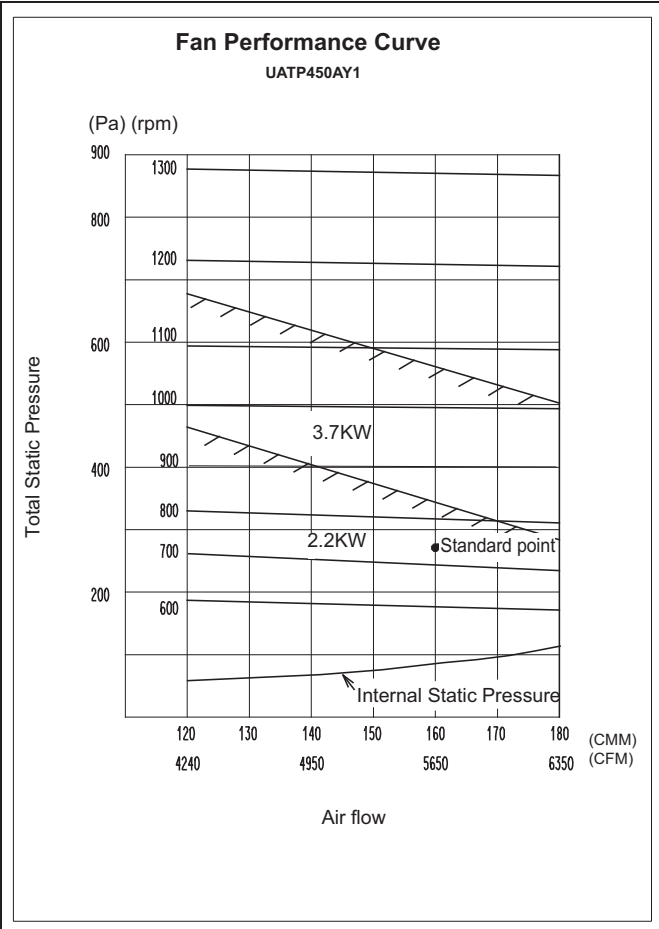
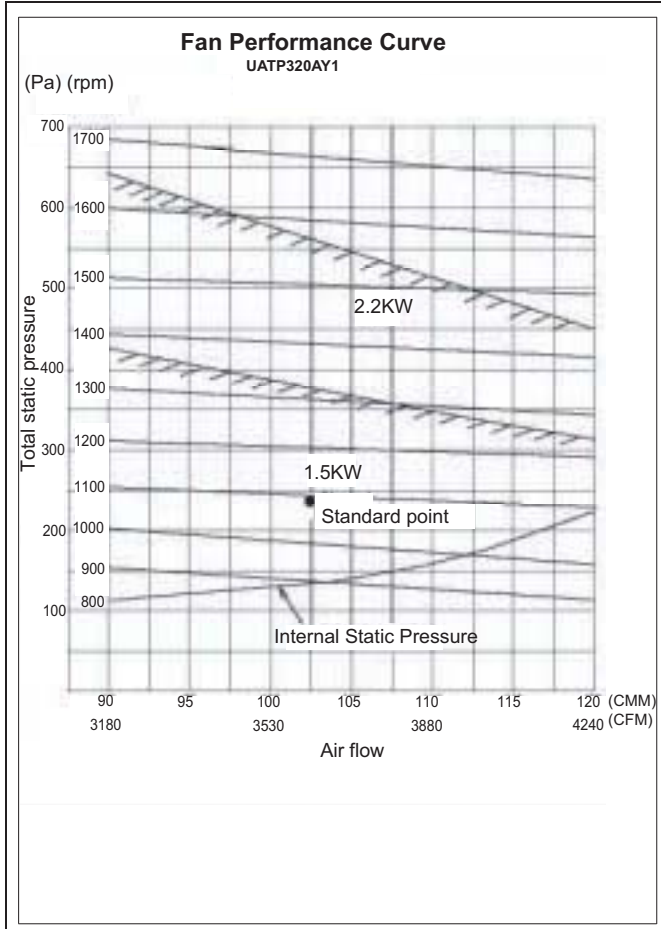
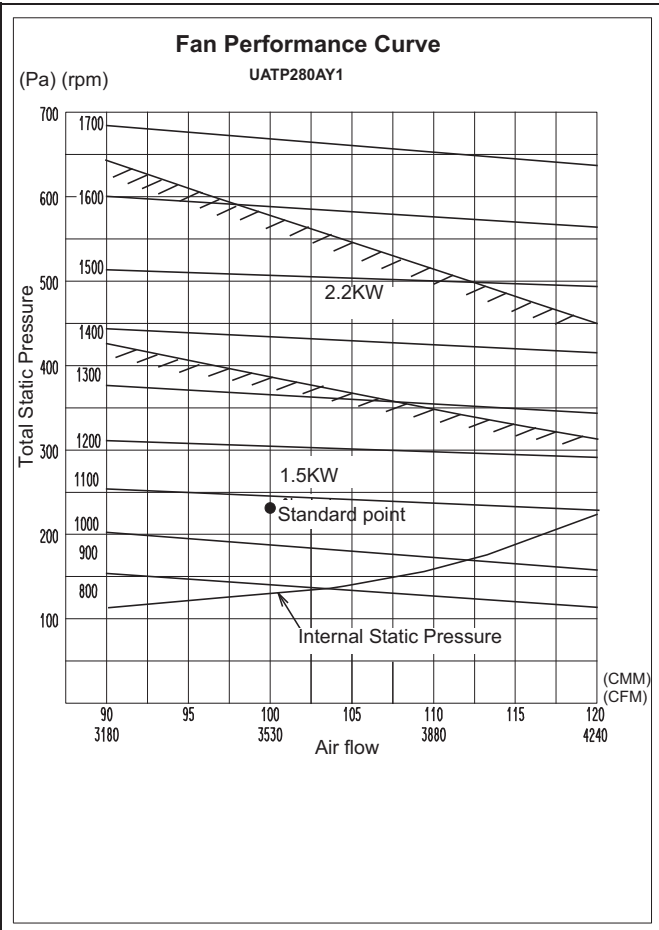
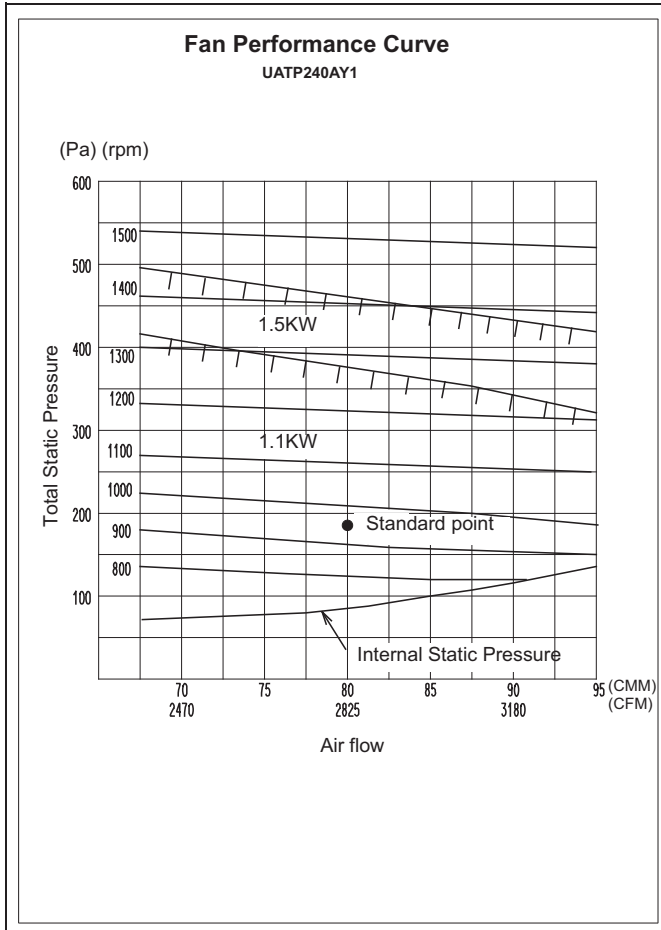

12 Fan characteristics

1
12

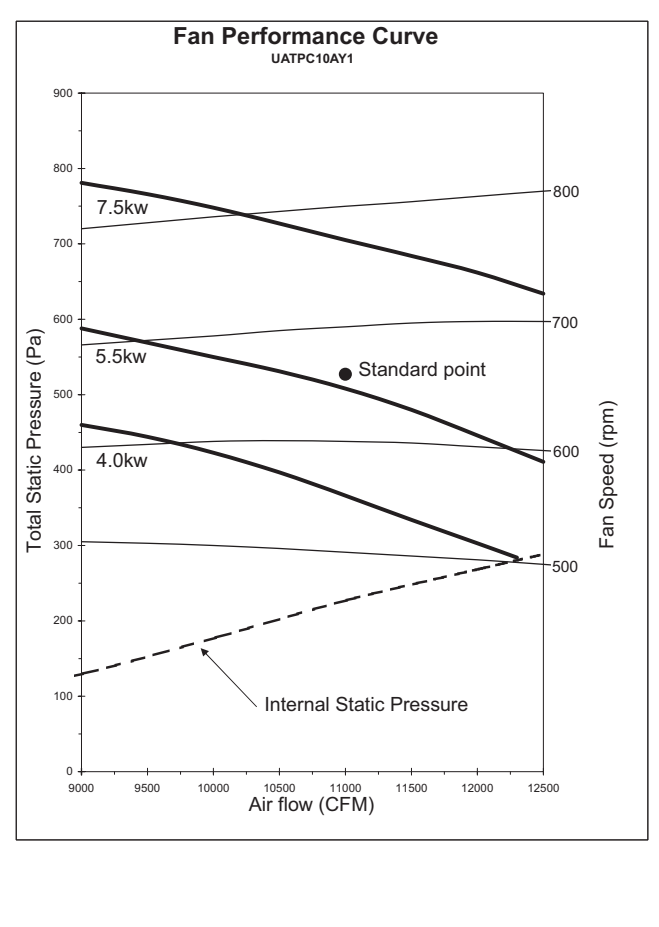
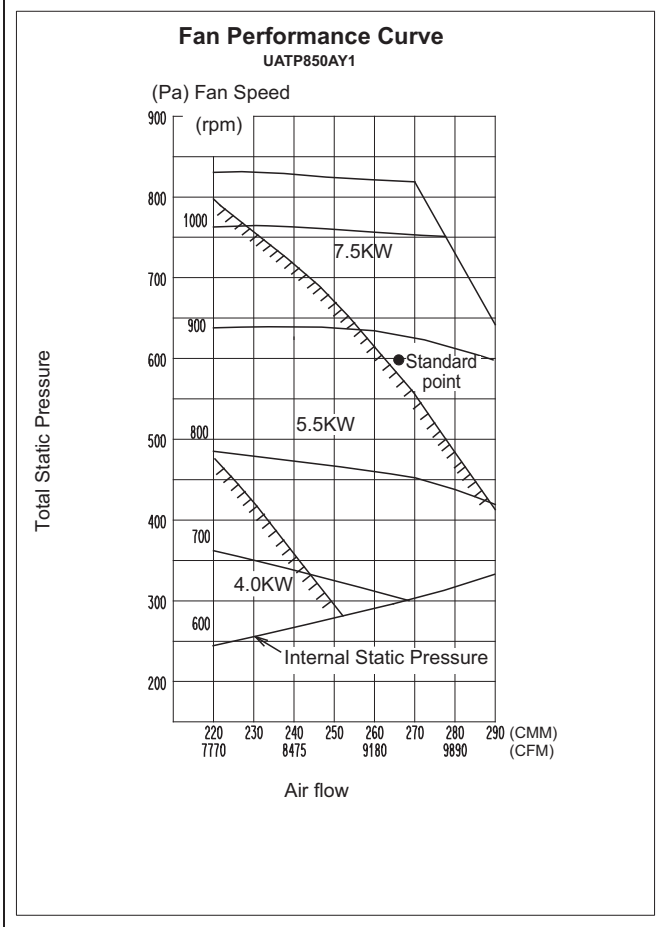
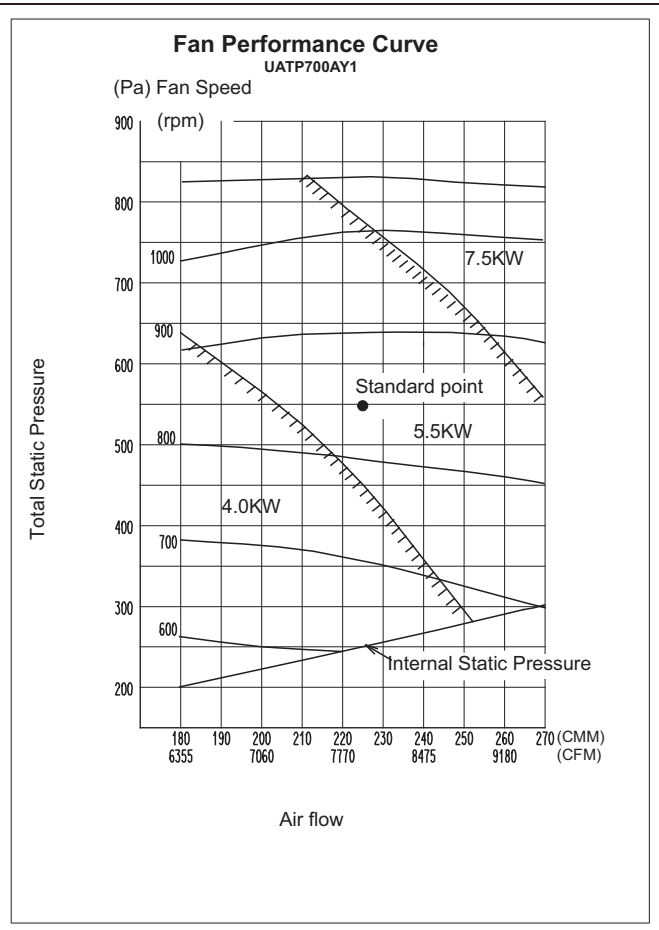
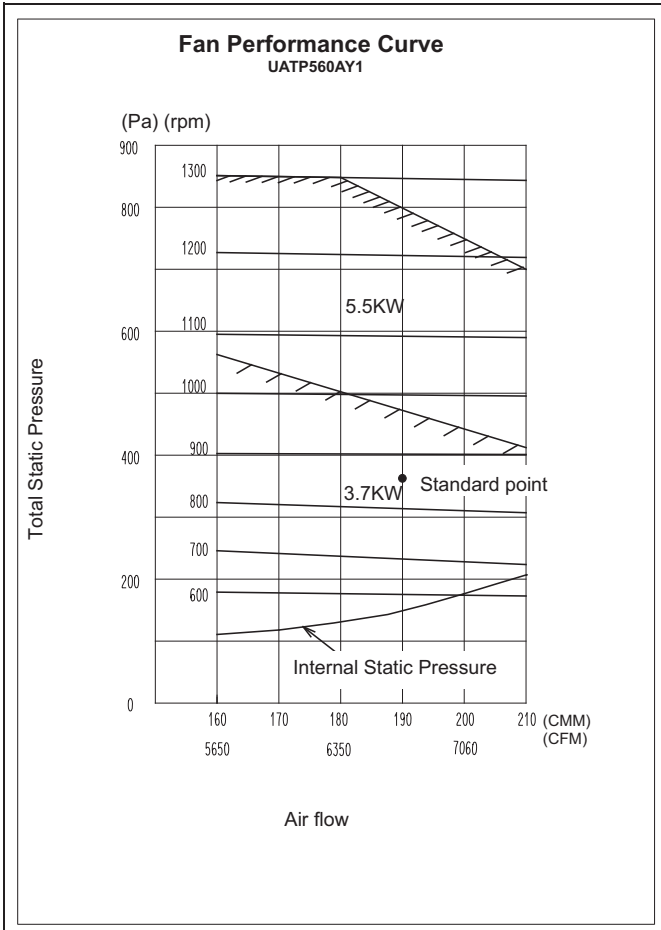

12 Fan characteristics

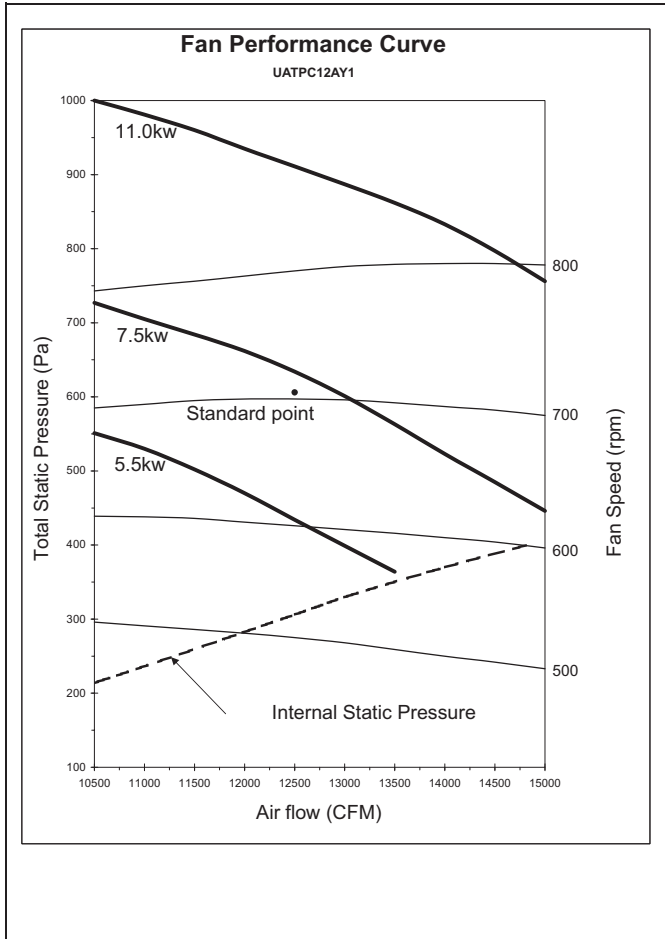

13 Operation range

1

13

UATP-AY1

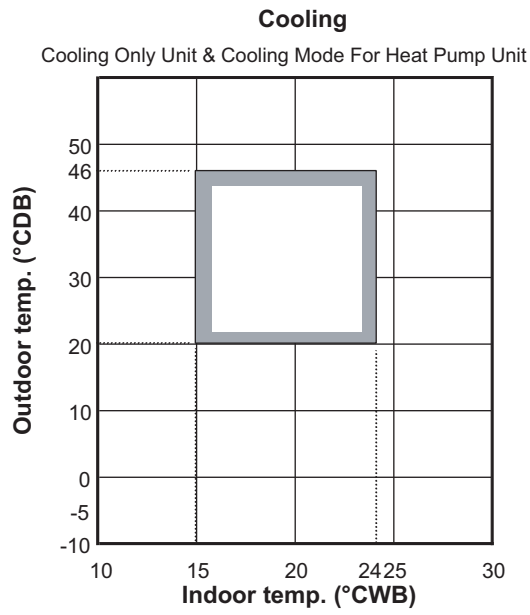

NOTES

- 1 The use of your air conditioner outside the range of working temperature and humidity can result in serious failure.

Rooftops



Daikin's unique position as a manufacturer of air conditioning equipment, compressors and refrigerants has led to its close involvement in environmental issues. For several years Daikin has had the intension to become a leader in the provision of products that have limited impact on the environment. This challenge demands the eco design and development of a wide range of products and an energy management system, resulting in energy conservation and a reduction of waste.



Daikin Europe N.V. is approved by LRQA for its Quality Management System in accordance with the ISO9001 standard. ISO9001 pertains to quality assurance regarding design, development, manufacturing as well as to services related to the product.



ISO14001 assures an effective environmental management system in order to help protect human health and the environment from the potential impact of our activities, products and services and to assist in maintaining and improving the quality of the environment.



Daikin units comply with the European regulations that guarantee the safety of the product.

The present publication is drawn up by way of information only and does not constitute an offer binding upon Daikin Europe N.V.. Daikin Europe N.V. has compiled the content of this publication to the best of its knowledge. No express or implied warranty is given for the completeness, accuracy, reliability or fitness for particular purpose of its content and the products and services presented therein. Specifications are subject to change without prior notice. Daikin Europe N.V. explicitly rejects any liability for any direct or indirect damage, in the broadest sense, arising from or related to the use and/or interpretation of this publication. All content is copyrighted by Daikin Europe N.V..

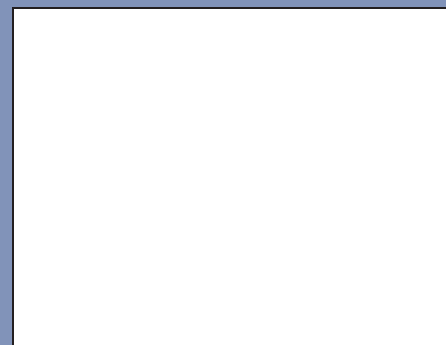

DAIKIN EUROPE N.V.

Naamloze Vennootschap
Zandvoordestraat 300
B-8400 Oostende, Belgium
www.daikin.eu
BTW: BE 0412 120 336
RPR Oostende



EEDEN07-105 • 09/2007 • Copyright • Daikin
Printed in Belgium by Lannoo (www.lannooprint.be), a company whose concern for the environment is set in the EMAS and ISO 14001 systems.
Responsible Editor: Daikin Europe N.V., Zandvoordestraat 300, B-8400 Oostende