



OPERATION MANUAL

Split system air conditioners

FUA71AVEB
FUA100AVEB
FUA125AVEB

CONTENTS

1. SAFETY PRECAUTIONS.....	1
2. WHAT TO DO BEFORE OPERATION.....	3
3. OPERATION RANGE.....	5
4. INSTALLATION SITE.....	5
5. OPERATION PROCEDURE.....	5
6. OPERATION CHARACTERISTICS.....	6
7. OPTIMUM OPERATION.....	8
8. MAINTENANCE (FOR SERVICE PERSONNEL).....	8
9. NOT MALFUNCTION OF THE AIR CONDITIONER.....	11
10. TROUBLESHOOTING.....	14
11. DISPOSAL REQUIREMENTS.....	15

The original instructions are written in English. All other languages are translations of the original instructions.

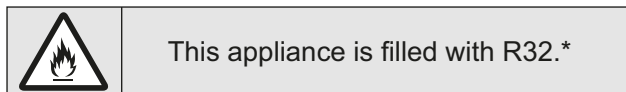

*Only applicable if this appliance is connected with the following models of outdoor units:
RZAG71, RZAG100, RZAG125, RZAG140,
RZASG71, RZASG100, RZASG125, RZASG140.

Important information regarding the refrigerant used

This product contains fluorinated greenhouse gases. Do not vent gases into the atmosphere.

Refrigerant type⁽¹⁾: **R410A or R32**
GWP⁽²⁾ value for **R410A** is **2087.5**
GWP⁽²⁾ value for **R32** is **675**

- ⁽¹⁾ For refrigerant used please refer to the nameplate of the outdoor unit.
⁽²⁾ GWP = global warming potential

Periodical inspections for refrigerant leaks may be required depending on European or local legislation. Please contact your local dealer for more information.



NOTICE regarding tCO₂eq

In Europe, the **greenhouse gas emissions** of the total refrigerant charge in the system (expressed as tonnes CO₂-equivalent) is used to determine the maintenance intervals. Follow the applicable legislation.

Formula to calculate the greenhouse gas emissions:

GWP value of the refrigerant × Total refrigerant charge [in kg] / 1000

1. SAFETY PRECAUTIONS

To gain full advantage of the air conditioner's functions and to avoid malfunction due to mishandling, please read this operation manual carefully before use.
This product comes under the term "appliances not accessible to the general public".

This appliance is intended to be used by expert or trained users in shops, in light industry and on farms, or for commercial and household use by lay persons.

This appliance can be used by children aged from 8 years and above and persons with reduced physical, sensory or mental capabilities or lack of experience and knowledge if they have been given supervision or instruction concerning use of the appliance in a safe way and understand the hazards involved. Children shall not play with the appliance. Cleaning and user maintenance shall not be made by children without supervision.

The appliance is not intended for use by unattended young children or persons who are incompetent to operate air conditioners.
It may result in injury or electric shocks.

- **This manual classifies the precautions into WARNINGS and CAUTIONS. Be sure to follow all the precautions below: They are all important for ensuring safety.**

! WARNING Indicates a potentially hazardous situation which, if not avoided, could result in death or serious injury.

! CAUTION Indicates a potentially hazardous situation which, if not avoided, may result in minor or moderate injury.
It may also be used to alert against unsafe practices.

- **After reading, keep this manual in a convenient place so that you can refer to it whenever necessary. If the equipment is transferred to a new user, be sure also to hand over the manual.**

! WARNING

When the air conditioner is malfunctioning (giving off a burning odor, etc.), turn off the power to the air conditioner and contact your local dealer.

Continued operation under such circumstances may result in a failure, electric shocks or a fire.

Consult your local dealer regarding modification, repair and maintenance of the air conditioner.

Improper workmanship may result in water leakage, electric shocks or a fire.

Be sure to use fuses with the correct ampere reading.

Do not use improper fuses, copper or other wiring as a substitute, as this may result in electric shocks, a fire, injury or damage to the air conditioner.

Consult your local dealer if the air conditioner undergoes a natural disaster, such as a flood or typhoon.

Do not operate the air conditioner in that case, or otherwise a malfunction, electric shocks, or a fire may result.

Start or stop the air conditioner with the remote controller. Never use the power circuit breaker for this purpose.

Otherwise, it may cause a fire or water leakage. Furthermore, if an automatic restart control is provided against power failure and the power is recovered, the fan will rotate suddenly and may cause injury.

Do not use the air conditioner in the atmosphere contaminated with oil vapor, such as cooking oil or machine oil vapor.

Oil vapor may cause crack damage to the air conditioner, electric shocks, or a fire.

Do not use flammable materials (e.g., hairspray or insecticide) near the air conditioner.

Do not clean the air conditioner with organic solvents such as paint thinner.

The use of organic solvents may cause crack damage to the air conditioner, electric shocks, or a fire.

Do not use the air conditioner in places with excessive oily smoke, such as cooking rooms, or in places with flammable gas, corrosive gas, or metal dust.

Using the air conditioner in such places may cause a fire or air conditioner failures.

Beware of a fire in case of refrigerant leakage.

If the air conditioner is not operating correctly, i.e. not generating cool or warm air, refrigerant leakage could be the cause. Consult your local dealer for assistance. The refrigerant used for the air conditioner is safe and normally does not leak. However, if the refrigerant leaks and gets in contact with a naked burner, heater or cooker, it may generate hazardous compounds. Turn off the air conditioner and call your local dealer. Turn on the air conditioner after the qualified service person makes sure to confirm that the leakage is repaired.

Do not place objects, including rods, your fingers, etc., in the air inlet or outlet.

Injury may result due to contact with the air conditioner's highspeed fan blades.

Consult your local dealer regarding cleaning the inside of the air conditioner.

Improper cleaning may cause breakage of plastic parts, water leakage and other damage as well as electric shocks.

Be aware that prolonged, direct exposure to cool or warm air from the air conditioner, or to air that is too cool or too warm can be harmful to your physical condition and health.

Consult your local dealer about installation work.

Doing the work yourself may result in water leakage, electric shocks or a fire.

Contact professional personnel about attachment of accessories and be sure to use only accessories specified by the manufacturer.

If a defect results from your own workmanship, it may result in water leakage, electric shocks or a fire.

Consult your local dealer regarding relocation and reinstallation of the air conditioner.

Improper installation work may result in leakage, electric shocks or a fire.

Be sure to earth the air conditioner.

Do not earth the air conditioner to a utility piping, lightning conductor or telephone earth lead.

Imperfect earthing may result in electric shocks or a fire. A high surge current from lightning or other sources may cause damage to the air conditioner.

Be sure to install an earth leakage breaker.

Failure to install an earth leakage breaker may result in electric shocks or a fire.

Be sure to use a dedicated power supply for the air conditioner.

The use of any other power supply may cause heat generation, a fire, or air conditioner failures.

Consult your local dealer regarding what to do in case of refrigerant leakage.

When the air conditioner is installed in a small room, it is necessary to take proper measures so that the amount of any leaked refrigerant does not exceed the concentration limit in the event of a leakage. Otherwise, this may lead to an accident due to oxygen depletion.

 **CAUTION**

Children should be watched so that they do not play with the indoor unit or its remote controller.

Accidental operation by a child may result in injury or electric shocks.

Do not allow a child to mount on the outdoor unit or avoid placing any object on it.

Falling or tumbling may result in injury.

Do not let children play on or around the outdoor unit. If they touch the unit carelessly, injury may be caused.

Be sure that children, plants or animals are not exposed directly to airflow from the indoor unit, as adverse effects may ensue.

Do not place flammable sprays or operate spray containers near the air conditioner as this may result in a fire.

Do not wash the air conditioner or the remote controller with water, as this may result in electric shocks or fire.

Do not place water containers (flower vases, etc.) on the indoor unit, as this may result in electric shocks or a fire.

Do not put flammable containers, such as spray cans, within 1 m from the air outlet.

The containers may explode because the warm air from the indoor or outdoor unit will affect them.

Turn off the power when the air conditioner is not used for long periods of time.

Otherwise, the air conditioner may get hot or catch on a fire due to dust accumulation.

Do not place objects in direct proximity of the outdoor unit and do not let leaves and other debris accumulate around the unit.

Leaves are a hotbed for small animals which can enter the unit. Once in the unit, such animals can cause malfunctions, smoke or a fire when making contact with electrical parts.

Before cleaning, be sure to stop the air conditioner operation, turn the power circuit breaker off.

Otherwise, an electric shocks and injury may result.

To avoid electric shocks, do not operate with wet hands.

Never touch the internal parts of the remote controller.

Touching certain internal parts will cause electric shocks and damage to the remote controller. Consult your local dealer about checking and adjustment of internal parts.

To avoid oxygen deficiency, ensure that the room is adequately ventilated if equipment such as a burner is used together with the air conditioner.

Do not leave the remote controller wherever there is a risk of wetting.

If water gets into the remote controller there is a risk of electrical leakage and damage to electronic components.

Watch your steps at the time of air filter cleaning or inspection.

High-place work is required, to which utmost attention must be paid.

If the scaffold is unstable, you may fall or topple down, thus causing injury.

Do not remove the outdoor unit's outlet side grille.

The grille protects against the unit's high speed fan, which may cause injury.

To avoid injury, do not touch the air inlet or aluminum fins of the air conditioner.

Do not place objects that are susceptible to moisture directly beneath the indoor or outdoor units.

Under certain conditions, condensation on the unit or refrigerant piping, air filter dirt or drain blockage may cause dripping, resulting in fouling or failure of the object concerned.

Do not place heaters directly below the indoor unit, as resulting heat can cause deformation.

Do not place appliances that produce naked flames in places exposed to the airflow from the air conditioner as this may impair combustion of the burner.

Do not block air inlets nor outlets.

Impaired airflow may result in insufficient performance or trouble.

Do not use the air conditioner for purposes other than those for which it is intended.

Do not use the air conditioner for cooling precision instruments, food, plants, animals or works of art as this may adversely affect the performance, quality and/or longevity of the object concerned.

Do not install the air conditioner at any place where there is a danger of flammable gas leakage.

In the event of a gas leakage, build-up of gas near the air conditioner may result in a fire.

Carry out drain piping properly to ensure complete drainage.

If drain piping is not carried out properly, drain will not flow out. Then, dirt and debris may be accumulated in the drain piping and may cause water leakage. If it occurs, stop the air conditioner and call your local dealer for assistance.

• NOTE TO SERVICE PERSONNEL

⚠ WARNING

⚠ RISK OF ELECTRIC SHOCKS OR A FIRE

- When checking the electric components (such as the inside of the control box, fan motor, drain pump, etc.), make sure to shut off all power supply for the air conditioner (including both indoor and outdoor units).
- When cleaning the heat exchanger, make sure to remove the electronic components above (If they get cleaning agent, there is a risk that the components will burn out because of insulation degradation).

⚠ CAUTION! DANGER OF ELECTRIC

- Shut off power supply before work.
- Never open the control box lid for 10 minutes after shutting off the power supply because there is residual voltage.
- After opening the control box lid, measure residual voltage between the points shown in **Fig. 1** on the printed circuit board by the tester without touching the live part and confirm that the residual voltage is DC50V or below.

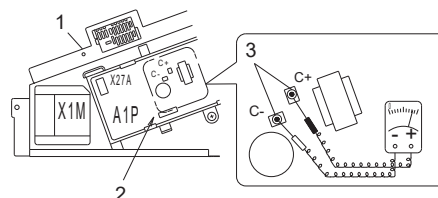

Figure 1

- 1 Control box
- 2 Printed circuit board
- 3 Measuring points for residual voltage

- After power failure, operation will restart automatically.

2. WHAT TO DO BEFORE OPERATION

This operation manual is for the following systems with standard control.

Before initiating operation, contact your local dealer for the operation that corresponds to your system.

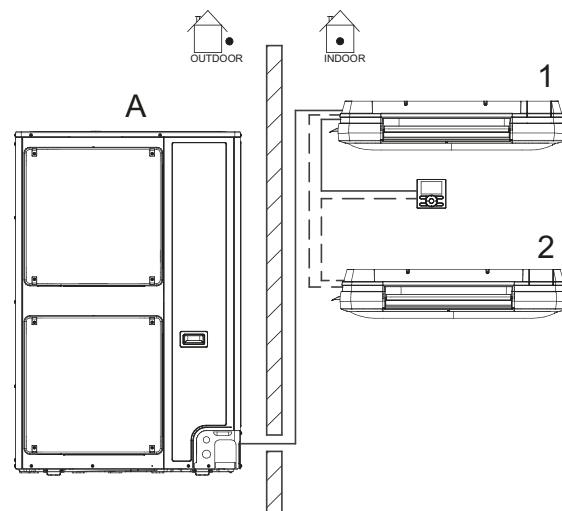

- A Pair system or simultaneous operation system
- B Multi system
- 1 Unit with remote controller
- 2 Unit without remote controller (when used as simultaneous operation)

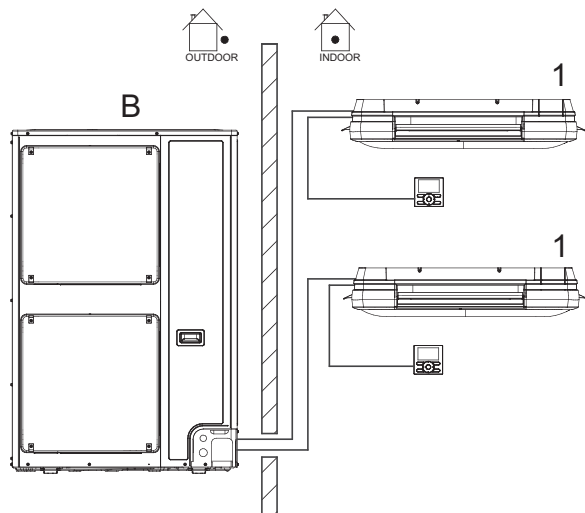

- A Pair system or simultaneous operation system
- B Multi system
- 1 Unit with remote controller
- 2 Unit without remote controller (when used as simultaneous operation)

NOTE

- Read the operation manual attached to the remote controller you are using.

When using a wireless remote controller, refer to the operation manual attached to the wireless remote controller kit.

If your installation has a customized control system, ask your local dealer for the operation that corresponds to your system.

- Heat pump type
This system provides COOLING, HEATING, AUTOMATIC, PROGRAM DRY, and FAN ONLY OPERATION modes.
- Cooling only type
This system provides COOLING, PROGRAM DRY, and FAN OPERATION modes.

PRECAUTIONS FOR GROUP CONTROL SYSTEM OR TWO REMOTE CONTROLLERS CONTROL SYSTEM

This system provides two other control systems beside individual control (one remote controller controls one indoor unit) system. Confirm the following if your unit is the following control system type.

- **Group control system**
One remote controller controls up to 16 indoor units. All indoor units are equally set.
- **Two remote controllers control system**
Two remote controllers control one indoor unit (In case of group control system, one group of indoor units).

NOTE

- Contact your local dealer in case of changing the combination or setting of group control and two remote controllers control systems.
- Please do not change the combination and settings for the group operation and two remote controllers control systems by yourself, but be sure to ask your local dealer.

Names and functions of parts

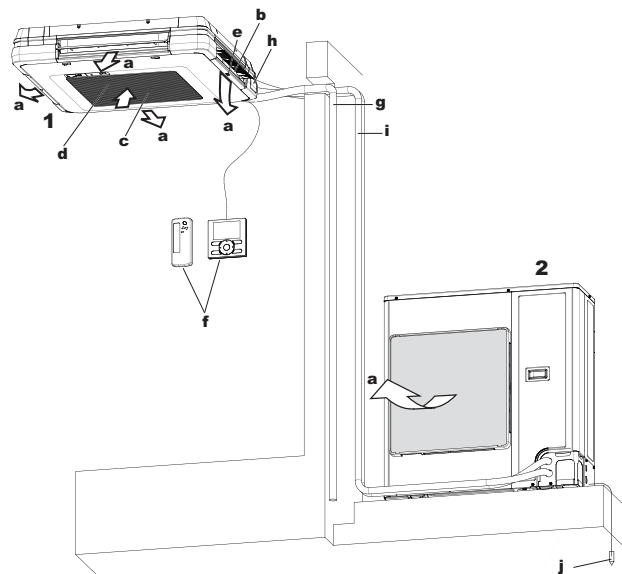

1	Indoor unit
2	Outdoor unit
a	Air discharge
b	Horizontal blade (inside air outlet)
c	Suction grille (Refer to " MAINTENANCE (FOR SERVICE PERSONNEL) " on page 8)
d	Air filter (inside suction grille) (Refer to " MAINTENANCE (FOR SERVICE PERSONNEL) " on page 8)
e	Air outlet identification mark (□, □□, □□□, □□□□) Use this mark as a reference for setting the airflow direction.(only for BRC1E53)
f	Remote controller (optional part) The remote controller may not be needed depending on the system configuration.
g	Drain piping
h	Draining device (built-in) It drains moisture in the room removed during the cooling operation.
i	Refrigerant piping; Transmission wiring; Earth wiring (Note) (Note) It is a wiring to let electricity flow from the indoor unit to the earth for prevention of electric shocks or a fire in case of emergency.
j	Earth wire Wire to ground from the outdoor unit to prevent electrical shocks and fire.

3. OPERATION RANGE

If the temperature or the humidity is beyond the following conditions, safety devices may work and the air conditioner may not operate, or sometimes, water may drop from the indoor unit.

COOLING [°C]

OUTDOOR UNIT	INDOOR			OUTDOOR TEMPERATURE	
		TEMPERATURE	HUMIDITY		
RZQG71/100/125/140	DB	18 to 37	80%* or below	DB	-15 to 50
	WB	12 to 28			
RZQ200	DB	20 to 37	80%* or below	DB	-5 to 46
	WB	14 to 28			

OUTDOOR UNIT	INDOOR			OUTDOOR TEMPERATURE	
		TEMPERATURE	HUMIDITY		
RZAG71/100/125/140	DB	18 to 37	80%* or below	DB	-20 to 52
	WB	12 to 28		WB	
RZASG71/100/125/140	DB	20 to 37	80%* or below	DB	-15 to 46
	WB	14 to 28		WB	

HEATING [°C]

OUTDOOR UNIT	INDOOR TEMPERATURE		OUTDOOR TEMPERATURE	
RZQG71/100/125/140	DB	10 to 27	DB	-19.5 to 21
			WB	-20 to 15.5
RZQ200	DB	10 to 27	DB	-14 to 21
			WB	-15 to 15

OUTDOOR UNIT	INDOOR TEMPERATURE		OUTDOOR TEMPERATURE	
RZAG71/100/125/140	DB	10 to 27	DB	-19.5 to 21
			WB	-20 to 15.5
RZASG71/100/125/140	DB	10 to 27	DB	-14 to 21
			WB	-15 to 15.5

*To avoid condensation and water dripping out the indoor unit.

D B: Dry bulb temperature

WB: Wet bulb temperature

The setting temperature range of the remote controller is 16°C-32°C depends on heating/cooling mode.

4. INSTALLATION SITE

Regarding places for installation

- **Is the air conditioner installed at a well-ventilated place where there are no obstacles around?**
- **Do not use the air conditioner in the following places.**
 - a. Filled with much mineral oil such as cutting oil
 - b. Where there is much salt such as a beach area
 - c. Where sulfured gas exists such as a hot-spring resort
 - d. Where there are considerable voltage fluctuations such as a factory or plant
 - e. Vehicles and vessels
 - f. Where there is much spray of oil and vapor such as a cookery, etc.

g. Where there are machines generating electromagnetic waves

h. Filled with acid and/or alkaline steam or vapor

- **Is a snow protection measure taken?**

For details, consult your local dealer about snow protection hoods, etc.

Regarding wiring

- **All wiring must be performed by an qualified personnel.**

To do wiring, ask your local dealer. Never do it by yourself.

- **Make sure that a separate power supply circuit is provided for this air conditioner and that all electrical work is carried out by qualified personnel according to local laws and regulations.**

Pay attention to running noises, too

- **Are the following places selected?**

a. A place that can sufficiently withstand the mass of the air conditioner with less running noises and vibrations.

b. A place where the hot wind discharged from the air outlet of the outdoor unit and the running noises do not cause a nuisance to neighbours.

- **Are you sure that there are no obstacles near the air outlet of the outdoor unit?**

Such obstacles may result in declined performance and increased running noises.

- **If abnormal noises occur in use, stop the operation of the air conditioner, consult your local dealer.**

Regarding drainage of drain piping

- **Is the drain piping carried out properly to ensure complete drainage?**

If drain piping is not carried out properly, dirt and debris may be accumulated in the drain piping and cause water leakage. If it occurs, stop the air conditioner and consult with your local dealer for assistance.

5. OPERATION PROCEDURE

Read the installation manual attached to the outdoor unit and manual for remote controller.

Operating procedure varies with heat pump and cooling only type. Contact your dealer to confirm your system type.

- To protect the air conditioner, turn on the main power switch 6 hours before operation.
- Do not shut off the power supply during seasonal use of the air conditioner.
This is required in order to activate the air conditioner smoothly.

- If the main power supply is turned off during operation, operation will restart automatically after the power turns back on again.

6. OPERATION CHARACTERISTICS

■ CHARACTERISTICS OF THE COOLING OPERATION (COOLING OPERATION AND AUTOMATIC COOLING OPERATION)

- If the COOLING OPERATION is used when the indoor temperature is low, frost adheres to the heat exchanger of the indoor unit. This can decrease the cooling capacity. In this case, the air conditioner automatically switches to the DEFROST OPERATION for a while. During the DEFROST OPERATION, the low fan speed or a gentle wind is used to prevent the discharge of melt water. (The remote controller displays the fan speed that is set.)
- When the outdoor temperature is high, it takes some time until the indoor temperature reaches the set temperature.

■ CHARACTERISTICS OF THE HEATING OPERATION (HEATING OPERATION AND AUTOMATIC HEATING OPERATION)

START OF OPERATION

- It generally takes a longer time for indoor temperature of the HEATING OPERATION to reach the set temperature compared to the COOLING OPERATION. It is advisable to start operation in advance using the TIMER OPERATION.

Perform the following operation to prevent heating capacity decrease and discharge of cool air.

AT THE START OF OPERATION AND AFTER THE DEFROST OPERATION

- A warm air circulating system is employed, and therefore it takes some time until the entire room is warmed up after the start of operation.
- The indoor fan runs to discharge a gentle wind automatically until the temperature inside the air conditioner reaches a certain level. At this time, the remote controller displays "❄️/🌀". Leave it as it stands and wait for a while. (The remote controller displays the fan speed that is set.)
- The airflow direction becomes horizontal to prevent a draft of cool air to the inhabitants. (The remote controller displays the set airflow direction that is set.)

DEFROST OPERATION

(Frost removal operation for the outdoor unit)

- As the frost on the coil of an outdoor unit increase, heating effect decreases and the air conditioner goes into the DEFROST OPERATION.
- The indoor unit fan stops and the remote controller display shows "❄️/🌀". With the wireless remote controller, the warm air stops, and the DEFROST OPERATION lamp on the light receiving unit turn on. (The remote controller displays the fan speed that is set.)
- After maximum 10 minutes of the DEFROST OPERATION, the air conditioner returns to the HEATING OPERATION.
- The airflow direction becomes horizontal. (The remote controller displays the airflow direction that is set.)
- During or after the DEFROST OPERATION, white mist comes out from the air inlet or outlet of the air conditioner. (Refer to "WHITE MIST COMES OUT OF THE AIR CONDITIONER" on page 13.)
- A hissing and "Shuh" sound may be heard during this particular operation.

Regarding outside air temperature and heating capacity

- The heating capacity of the air conditioner declines as the outside air temperature falls. In such a case, use the air conditioner in combination with other heating systems. (When a combustion appliance is used, ventilate the room regularly.) Do not use the combustion appliance where the air from the air conditioner is blown directly toward it.
- When the warm air stays under the ceiling and your feet are cold, we recommend that you use a circulator (a fan to circulate the air inside the room). For details, consult your local dealer.
- When the indoor temperature exceeds the set temperature, the indoor unit discharges a gentle breeze (switches to gentle wind). The airflow direction becomes horizontal. (The remote controller displays the fan speed and airflow direction that are set.)

■ CHARACTERISTICS OF THE PROGRAM DRY OPERATION

- This operation lowers the humidity without lowering the indoor temperature. The indoor temperature when the operation button is pressed will be the set temperature. At this time, the fan speed and temperature are set automatically, so the remote controller does not display the fan speed and set temperature.

To efficiently lower the indoor temperature and humidity, first use the COOLING OPERATION to lower the indoor temperature, and then use the PROGRAM DRY OPERATION. When the indoor temperature is lowered, airflow from the indoor unit may stop.

- When operating continuously at downward airflow direction, air blows in the automatic set direction for a period of time to prevent condensation on the horizontal blades. (The remote controller displays the airflow direction that is set.)
- If the PROGRAM DRY OPERATION is used when the indoor temperature is low, frost forms the heat exchanger of the indoor unit. In this case, the air conditioner automatically switches to the DEFROST OPERATION for a while. The low fan speed or a gentle wind is used to prevent the discharge of melt water.

■ SOUND PRESSURE LEVEL

- Sound pressure level is less than 70 dB(A).

AIRFLOW DIRECTION ADJUST

Airflow direction adjust can be individually set for each air outlet. (only BRC1E53)

- Check the air outlet identification mark (refer to page 4), and use the remote controller to set the airflow direction. (For details, refer to the operation manual attached to the remote controller.)
- The horizontal blades at the air outlet are closed while the indoor unit stops.



AIRFLOW DIRECTION ADJUST

Press the AIRFLOW DIRECTION ADJUST/SETTING button to adjust the airflow direction.

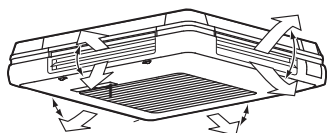

Up and down adjustment

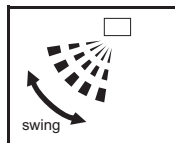

The AIRFLOW DIRECTION display swings as shown left and the airflow direction continuously varies. (Automatic swing setting)



Press AIRFLOW DIRECTION ADJUST/SETTING button to select the air direction of your choice.

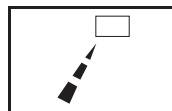

The AIRFLOW DIRECTION display stops swinging and the airflow direction is fixed (Fixed airflow direction setting).

MOVEMENT OF THE HORIZONTAL BLADE

For the following conditions, micro computer controls the airflow direction so it may be different from the display.

Operation mode	<ul style="list-style-type: none"> • COOLING • AUTOMATIC COOLING • PROGRAM DRY 	<ul style="list-style-type: none"> • HEATING • AUTOMATIC HEATING
Up and down direction	Air blows in the automatic set direction for a period of time to prevent condensation on the horizontal blades. <ul style="list-style-type: none"> • When operating continuously at downward airflow direction 	The airflow direction becomes horizontal so that it does not blow directly toward your body. <ul style="list-style-type: none"> • When room temperature is higher than the set temperature • When the HEATING OPERATION starts or during the DEFROST OPERATION (if frost forms on the outdoor unit)

NOTE

- When group control is performed on the simultaneous operation system (twin and triple), airflow direction cannot be individually set on the slave units.

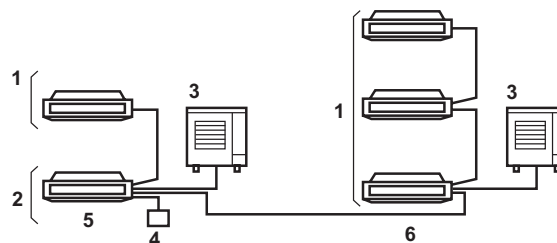

- 1 Indoor unit (Slave)
- 2 Indoor unit (Master)
- 3 Outdoor unit
- 4 Remote controller
- 5 Twin
- 6 Triple

Recommended airflow direction positions

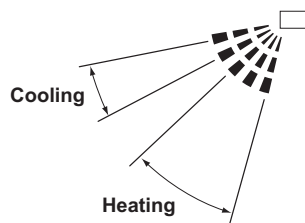

We recommend using the airflow in the position listed above when fixing the airflow direction.

7. OPTIMUM OPERATION

Observe the following precautions to ensure the air conditioner operates.

- Prevent direct sunlight from the window by using curtains or blinds during the COOLING OPERATION.
- Keep doors and windows closed. If the doors and windows remain open, room air will flow out and decrease the effect of cooling and heating.
- Never place objects near the air inlet and the air outlet of the air conditioner. It may decrease the effect or stop the operation.
- Adjust the room temperature properly for a comfortable environment. Avoid excessive heating or cooling. Not doing so wastes electricity.
- When the display shows "  " or "Time to clean filter", ask a qualified service person to clean the filters.

(Refer to "**MAINTENANCE (FOR SERVICE PERSONNEL)**" on page 8.)

Operating the indoor unit with stained air filter may decrease capacity or cause malfunction.

- Install TVs, radios, and stereos 1 m or more away from the indoor unit and remote controller. Images may become fuzzy and noise may be generated.
- Turn off the power circuit breaker when it is not in use for a long period. When the power circuit breaker is turned on, small amount of power is consumed even if the air conditioner is not in operation. (*1)

Turn off the power circuit breaker for saving energy. When reoperating, turn on the power circuit breaker 6 hours before operation for smooth running.

(Refer to "**MAINTENANCE (FOR SERVICE PERSONNEL)**" on page 8) (*2)

*1 The consumed power while the outdoor unit is not in operation depends on the model.

*2 The setting before the power circuit breaker is cut off is stored. (The timer setting is cleared.)

- Fully use the function of airflow direction adjust.

Cold air gathers on the floor, and warm air gathers under the ceiling.

Set the air direction to horizontal during the COOLING or PROGRAM DRY OPERATION, and set it downwards during the HEATING OPERATION.

Do not let the air blow directly to a person.

- Use the TIMER OPERATION effectively. It takes some time until the indoor temperature reaches the set temperature. It is advisable to start operation in advance using the TIMER OPERATION.

8. MAINTENANCE (FOR SERVICE PERSONNEL)

ONLY A QUALIFIED SERVICE PERSON IS ALLOWED TO PERFORM MAINTENANCE

— WARNING —

- Do not use flammable gas (such as hair sprays and insecticides) near the air conditioner.
- Do not wipe the air conditioner with benzine or thinner. It may cause cracks, electric shocks or a fire.
- Never put your fingers or rods in the air inlet, air outlet or horizontal blade. The fan is rotating at high speed, so you would get injured.

— CAUTION —

- Do not wash the air conditioner with water. It may cause electric shocks or a fire due to leakage.
- Make sure to turn off the air conditioner when taking care of the air conditioner and disconnect the power supply breaker. Unless the power supply is disconnected, it may cause electric shocks and injuries.
- When working at a high place, give caution to your footing. If the scaffold is unstable, it may cause injuries due to fall and stumbling.

NOTE

- Do not remove the air filter unless for cleaning. It may cause failure.
- Do not attach substance (such as paper towels) other than the specified air filter to the air inlet. The performance may drop and cause freeze-up/water leakage.

HOW TO CLEAN THE AIR FILTER

When the remote controller indicates " " or "Time to clean filter", clean the air filter.

- It indicates after running for a certain time.

NOTE

- You may change the time of indication " " or "Time to clean filter".

If the indoor unit is used in a space where the air is more contaminated, ask your local dealer for solution.

Contamination	Time until indication is displayed
Normal	2500 hours (equivalent to one year)
More contaminated	1250 hours (equivalent to a half year)

- If it becomes difficult to remove contamination from the air filter, replace the air filter. (Air filter for replacement is an optional accessory)

1. Open the suction grille.

Simultaneously slide the two knobs, slowly down the suction grille.

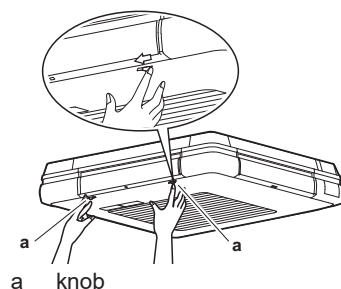

2. Take out the air filter.

Carry out the work in the order mentioned below.

- 1 Pull the air filter end inclined downward and unhook the hooking hole of the air filter from the projection of the grille. (both right and left)
- 2 Lift the air filter and unhook the hooking hole of the air filter from the projection at the grille upper part. (both left and right)

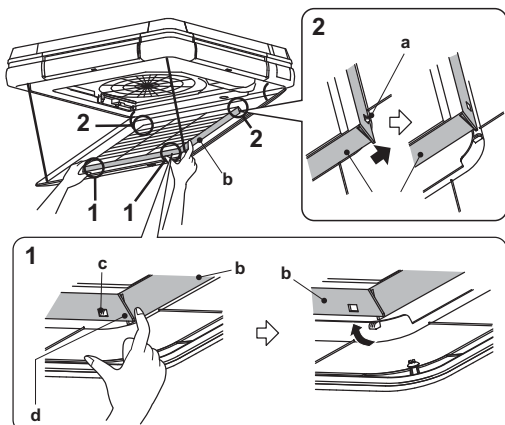

- a Grille upper part projection
- b Filter
- c Projection
- d Air filter end

3. Clean the filter.

Clean the contamination with a vacuum cleaner or wash it with water.

If the air filter is extremely contaminated, wash it with neutral detergent using a soft brush.



After dewatering, dry the air filter in the shade.

NOTE

- **Do not wash the air filter with water of 50°C or higher. It may cause decolorization and deformation.**
- **Do not heat the filter with fire. It may cause burning.**

4. Attach the air filter.

Attach the air filter in the reverse order mentioned in step 2.

5. Close the suction grille.

Simultaneously slide the two knobs, slowly lift the suction grille and securely fix it in the reverse order mentioned in step 1.

6. Turn off the indication " " or "Time to clean filter" displayed on the remote controller after turning on the power.

- For details, refer to the operation manual attached to the remote controller. The indication can be turned off whether in operation or at stop.

NOTE

- When closing the suction grille, the strap is likely to be sandwiched. **Before closing the suction grille, confirm if the strap is not sticking out from the side of the suction grille.**

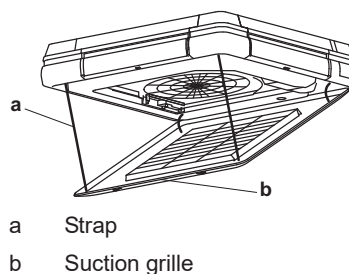

HOW TO CLEAN THE SUCTION GRILLE

1. Open the suction grille.

Simultaneously slide the two knobs, slowly down the suction grille.

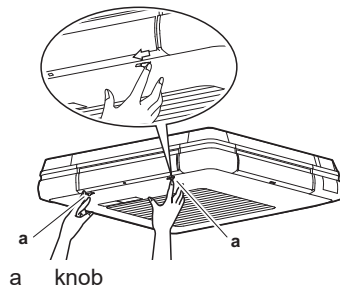

2. Remove the suction grille.

- 1 Remove the 4 straps attached to the indoor unit. (Refer to the figure shown below.)
- 2 Open the suction grille to 45° and lift it. Then, unhook it from the place to hook. (3 places)

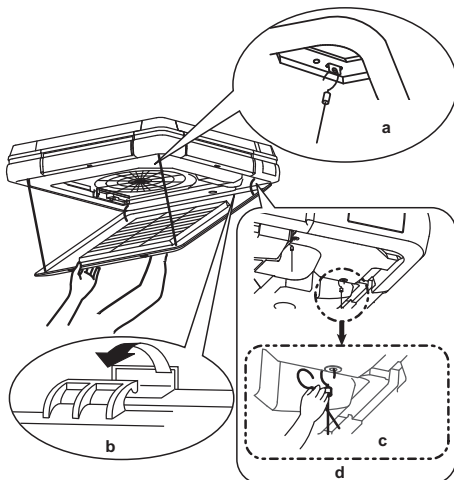

- a Place where the straps are to be hooked (A total of 4 places)
- b Place to hook (3 places)
- c Unhook the hook
- d Place where the straps are to be hooked

3. Take out the air filter.

Refer to step 2 of "HOW TO CLEAN THE AIR FILTER" on page 9.

4. Clean the suction grille.

Wash the suction grille with neutral detergent using a soft brush and then dewater.



Detergent

When the suction grille is extremely contaminated

- Spray the detergent for a ventilating fans and ranges directly to the suction grille, and keep it under that condition for about 10 minutes. After that, carefully wash the suction grille with water.

NOTE

- Do not wash the suction grille with warm water of 50°C or higher. It may cause discoloration and deformation.
 - When drying the suction grille, do not heat it with fire. It may cause burning.
 - Do not use such as gasoline, benzine, thinner, polishing powder and liquid insecticide sold in the market. It may cause discoloration and deformation.
5. Attach the air filter.
Refer to step 4 of "HOW TO CLEAN THE AIR FILTER" on page 9.
 6. Attach the suction grille.
Attach the suction grille in the reverse order mentioned in step 2.
 7. Close the suction grille.
Simultaneously slide the 2 knobs in the reverse order mentioned in step 1, slowly lift the suction grille and securely fix it.

HOW TO CLEAN OUTSIDE PANELS AND REMOTE CONTROLLER

- Wipe them with a dry soft cloth.
- When the stain cannot be wiped off, dip the cloth in the neutral detergent diluted with water and twist the cloth. After wiping off stain with this cloth, wipe them with dry cloth.

NOTE

- Do not use such as gasoline, benzine, thinner, polishing powder and liquid insecticide sold in the market. It may cause discoloration and deformation.
- Do not wash them with warm water of 50°C or higher. It may cause discoloration and deformation.

■ CLEANING BEFORE AND AFTER SEASONAL USE

WHAT TO DO WHEN START UP AFTER A LONG STOP

Confirm the following.

- Check that the air inlet and outlet of indoor and outdoor unit are not blocked.
Remove any obstacle.
Obstacles decrease the fan speed, and cause performance decrease and breakage of the devices.

Clean the air filter.

- After cleaning the air filter, make sure to attach it. (Refer to "**MAINTENANCE (FOR SERVICE PERSONNEL)**" on page 8.)
For information on how to install, remove, or clean a optional sold air filter, refer to the user's manual attached to the air filter.
- Turn off the indication "  " or "Time to clean filter" displayed on the remote controller after turning on the power.
- For details, refer to the operation manual attached to the remote controller.
The indication can be turned off whether in operation or at stop.

Turn on the power circuit breaker at least 6 hours before operation.

- This is required in order to activate the air conditioner smoothly, and to protect the air conditioner.
- The display on the remote controller will be shown when the power circuit breaker is turned on.

HEATING OPERATION within 6 hours after power is supplied to the air conditioner.

Some model series perform the following operation to protect the devices.

If the HEATING OPERATION is performed within 6 hours after power is supplied to the air conditioner, the indoor fan stops for about 10 minutes during the outdoor unit operation to protect the devices.

The above operation is performed not only for installation, but every time the power circuit breaker is turned off/on.

For comfortable use, do not turn off the power circuit breaker during seasonal use of the HEATING OPERATION.

WHAT TO DO WHEN STOPPING THE AIR CONDITIONER FOR A LONG PERIOD

Turn on FAN OPERATION for a half day on the fine day and dry the indoor unit.

- This can prevent the causes of mould.

Turn off the power circuit breaker.

- During the power circuit breaker is turned on, some watts of electricity is being used even if the air conditioner is not operating.
Turn off the power circuit breaker for saving energy.
- The display on the remote controller will vanish when the power circuit breaker is turned off.

Clean the air filter.

- Be sure to replace the air filter to its original place after cleaning.
(Refer to "**MAINTENANCE (FOR SERVICE PERSONNEL)**" on page 8.)
For information on how to install, remove, or clean an optional sold air filter, refer to the user's manual attached to the air filter.

NOTE

The inside of the air conditioner may become contaminated after several seasons of use, potentially causing performance degradation and water leakage.

Ask your local dealer for details on cleaning the inside of the indoor unit. This operation requires a qualified service person.

9. NOT MALFUNCTION OF THE AIR CONDITIONER

The following symptoms do not indicate air conditioner malfunction

- HEATING OPERATION within 6 hours after the power is supplied to the air conditioner.
Some model series perform the following operation to protect the devices.
If the HEATING OPERATION is performed within 6 hours after the power is supplied to the air conditioner, the indoor fan stops for about 10 minutes during the outdoor unit operation to protect the devices.
The above operation is performed not only for installation, but every time the power circuit breaker is turned off/on.
For comfortable use, do not turn off the power circuit breaker during seasonal use of the HEATING OPERATION.

I. THE AIR CONDITIONER DOES NOT OPERATE

- **The air conditioner does not restart immediately after the ON/OFF button is pressed.**
- **The air conditioner does not restart immediately when TEMPERATURE SETTING button is returned to the former position after pushing the button.**

If the OPERATION lamp lights, the air conditioner is in normal condition.

It does not restart immediately because a safety device operates to prevent overload of the air conditioner.

After 3 minutes, the air conditioner will start again automatically.

- **The air conditioner does not start when the display shows "  " and it flashes for few seconds after pressing an operation button.**

This is because the air conditioner is under centralized control.

Flashes on the display indicates that the air conditioner cannot be controlled by the remote controller.

- **HEATING OPERATION within 6 hours after power is supplied to the air conditioner.**

Some model series perform the following operation to protect the devices.

If the HEATING OPERATION is performed within 6 hours after power is supplied to the air conditioner, the indoor fan stops for about 10 minutes during the outdoor unit operation to protect the devices.

The above operation is performed not only for installation, but every time the power circuit breaker is turned off/on.

For comfortable use, do not turn off the power circuit breaker during seasonal use of the HEATING OPERATION.

- **The outdoor unit stops.**

This is because the indoor temperature has reached the set temperature.

The indoor unit is in the FAN OPERATION.

COOLING OPERATION
(AUTOMATIC COOLING OPERATION):

Lower the set temperature.

HEATING OPERATION
(AUTOMATIC HEATING OPERATION):

Raise the set temperature.

The operation starts after a while when the air conditioner is in normal condition.

- **The remote controller displays "  ", and airflow stops.**

This is because the air conditioner automatically switches to the DEFROST OPERATION to prevent a decrease in heating capacity when frost on the outdoor unit increases.

After maximum 10 minutes, the air conditioner returns to its original operation.

II. THE OPERATION SOMETIMES STOPS

- **The remote controller displays "U4" and "U5", and the operation stops. However, it will restart in a few minutes.**

This is because communication between the indoor and outdoor units or indoor units and remote controllers is shut off and stopped due to noise caused by devices other than the air conditioner.

When the electrical noise decreases, the air conditioner automatically restarts.

III. THE FAN SPEED IS DIFFERENT FROM THE SETTING

- **Pressing the fan speed control button does not change the fan speed.**

During the COOLING OPERATION, the low fan speed or a gentle wind is used to prevent the discharge of melt water.

During the DEFROST OPERATION (HEATING OPERATION), the wind from the air conditioner stops to prevent air discharge directly toward your body. After a while, the fan speed can be changed.

(The fan speed cannot be set for the PROGRAM DRY OPERATION.)

When the room temperature reaches the set temperature during the HEATING OPERATION, the outdoor unit stops and the indoor unit goes into gentle wind.

It takes some time until the fan speed changes.

Raise the set temperature.

After a while, the fan speed changes.

IV. THE AIRFLOW DIRECTION IS DIFFERENT FROM THE SETTING, OR THE AIRFLOW DIRECTION IS DIFFERENT FROM THE DISPLAY ON THE REMOTE CONTROLLER

- **The horizontal blades do not swing when the remote controller displays the swing operation.**

<HEATING OPERATION>

This is because the airflow direction is controlled so it is horizontal direction after the operation starts or when the indoor temperature is higher than the set temperature to prevent air discharge directly toward your body.

After a while, the swing operation starts.

(Refer to "**MOVEMENT OF THE HORIZONTAL BLADE**" on page 7.)

- **The airflow direction display of the remote controller differs from the actual operation of the horizontal blades.**

<COOLING and PROGRAM DRY OPERATIONS>

When the operation in a downward airflow direction is set, the airflow direction differs from the display for a period of time to prevent condensation on the horizontal blades.

<HEATING OPERATION>

This is because the airflow direction is controlled so it is horizontal direction after the operation starts or when the indoor temperature is higher than the set temperature to prevent air discharge directly toward your body.

After a while, the airflow direction changes to the set direction.

(Refer to "**MOVEMENT OF THE HORIZONTAL BLADE**" on page 7.)

V. HORIZONTAL BLADES DO NOT CLOSE

- **The horizontal blades do not close even when operation stops.**

This is because the horizontal blades close once airflow from the air conditioner stops. After a while, the horizontal blades close.

VI. WHITE MIST COMES OUT OF THE AIR CONDITIONER

- **When humidity is high during the COOLING OPERATION. (In oily or dusty places)**

If the inside of an indoor unit is extremely contaminated, the temperature distribution inside a room becomes uneven.

It is necessary to clean the inside of the indoor unit.

Ask your local dealer for details on cleaning the indoor unit.

This cleaning requires a qualified service person.

Check the usage environment.

- **When the air conditioner is changed over to the HEATING OPERATION after the DEFROST OPERATION and in the DEFROST OPERATION.**

Moisture generated by defrost becomes steam and exists.

When the remote controller display shows "", DEFROST OPERATION is being used.

VII. NOISE OF AIR CONDITIONERS

- **A ringing sound after the indoor unit is started.**

This sound is generated when the motors for driving the horizontal blades are working. It will quiet down after about a minute.

- **A low continuous flow "Shuh" sound which is heard when the air conditioner is in the COOLING or DEFROST OPERATION or a trickling sound which is heard when the air conditioner is in the DEFROST OPERATION.**

This is the sound of refrigerant gas flowing through both indoor and outdoor units.

- **A "Shuh" sound which is heard at the start or immediately after the stop of operation or which is heard at the start or immediately after the stop of the DEFROST OPERATION.**

This is the noise of refrigerant caused by flow stop and flow change.

During the HEATING OPERATION, the air conditioner switches to the DEFROST OPERATION automatically.

The remote controller shows "".

After maximum 10 minutes, the air conditioner returns to its original operation.

- **A continuous flow "Shah" sound is heard when the air conditioner is in the COOLING OPERATION or at a stop.**

The noise is heard when the drain pump is in operation.

Liquid removed from the indoor air during the COOLING OPERATION is discharged.

- **A "Pishi-pishi" squeaking sound is heard when the air conditioner is in operation or after the stop of operation.**

Expansion and contraction of resin parts caused by temperature change makes this noise.

VIII. DUST FROM THE INDOOR UNITS

- **Dust may blow out from the unit after starting operation from long resting time.**

Dust absorbed by the unit blows out.

IX. THE INDOOR UNITS GIVE OFF ODORS

- **During operation**

The unit absorbs the smell of rooms, furniture, cigarettes, etc., and then emits them.

If odor is a concern, set the fan speed to no airflow when the indoor temperature reaches the set temperature.

For details, contact your local dealer.

X. THE AIR CONDITIONER DOES NOT COOL EFFECTIVELY

- **The air conditioner is operating in PROGRAM DRY OPERATION.**

This is because program dry mode operates so that the indoor temperature decreases as little as possible.

Lower the indoor temperature using the COOLING OPERATION, and then use the PROGRAM DRY OPERATION.

(Refer to "CHARACTERISTICS OF THE PROGRAM DRY OPERATION" on page 7.)

- **Read through characteristics of the COOLING OPERATION, characteristics of the HEATING OPERATION, and characteristics of the PROGRAM DRY OPERATION on page 7.**

10. TROUBLESHOOTING

Please check before requesting a service.

1. If the air conditioner does not operate at all.

- Check if fuse has blown.
Turn off the power supply.

- Check if the power circuit breaker is blown.
If the tab of power circuit breaker is in the OFF position, turn the power on with the power circuit breaker switch.
If the tab of power circuit breaker is in the trip position, do not turn the power on with the power circuit breaker switch.
Contact your local dealer.

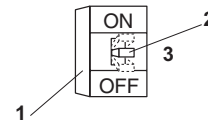

- 1 Power circuit breaker (earth leakage breaker)
- 2 Tab
- 3 Trip position

- Check if there is a power failure.
Wait until power is restored. If power failure occurs during operation, the air conditioner automatically restarts immediately after the power supply recovers.

2. If the air conditioner stops after operating the air conditioner.

- Check if the air inlet or outlet of outdoor or indoor unit is blocked by obstacles.
Remove the obstacle and make it well-ventilated.
The horizontal blades at the air outlet are closed while the indoor stops.
- Check if the air filter is clogged.
Ask a qualified service person to clean the air filters.
A decrease in the airflow volume of the air conditioner will result and the performance of the air conditioner will be degraded and power consumption will increase if the air filter is clogged with dust or dirt.
In addition, this may cause dew condensation at the air outlet.
(Refer to "MAINTENANCE (FOR SERVICE PERSONNEL)" on page 8.)

3. The air conditioner operates but it does not sufficiently cool or heat.

- Check if the air inlet or outlet of outdoor or indoor unit is blocked by obstacles.
Remove the obstacle and make it well-ventilated.
The horizontal blades at the air outlet are closed while the indoor unit stops.
Obstacles decrease the fan speed, and cause performance decrease and breakage when discharged air is suctioned.
They cause a waste of electricity, and that may stop the devices.

- Check if the air filter is clogged.
Ask a qualified service person to clean the air filters.

A decrease in the airflow volume of the air conditioner will result and the performance of the air conditioner will be degraded and power consumption will increase if the air filter is clogged with dust or dirt.

In addition, this may cause dew condensation at the air outlet.

(Refer to "**MAINTENANCE (FOR SERVICE PERSONNEL)**" on page 8.)

- Check if the set temperature is not proper.
Set to an appropriate temperature, fan speed, and airflow direction.
- Check if the FAN SPEED button is set to LOW SPEED.
Set to an appropriate temperature, fan speed, and airflow direction.
- Check if the airflow direction is not proper.
Set to an appropriate temperature, fan speed, and airflow direction.
- Check if the doors or the windows are open.
Shut doors or windows to prevent wind from coming in.
- Check if direct sunlight enters the room (when cooling).
Use curtains or blinds.
- When there are too many inhabitants in the room (when cooling).
- Check if the heat source of the room is excessive (when cooling).

4. Operation was performed or stopped although the on/off button was not pressed.

- Are you sure that the ON/OFF timer operation is not used?
Turn off the ON/OFF timer.
Please refer to operation manual attached to the remote controller.
- Are you sure that any remote control device is not connected?
Contact the central control room that directed the stop.
- Are you sure that the display for centralized control is not lit?
Contact the central control room that directed the stop.

If the problem is not solved after checking the above points, please do not try to repair it yourself.

In such cases, always ask your local dealer. At this time, please tell the symptom and model name (written on the model name plate).

If one of the following malfunctions occurs, take the measures shown below and contact your local dealer.

The air conditioner must be repaired by a qualified service person.

⚠ WARNING

When the air conditioner is malfunctioning (giving off a burning odor, etc.), turn off power to the air conditioner and contact your local dealer.

Continued operation under such circumstances may result in a failure, electric shocks or a fire. Contact your local dealer.

- If a safety device such as a fuse, a power circuit breaker or an earth leakage breaker frequently actuates;
Measure: Do not turn on the main power switch.
- If the ON/OFF switch does not properly work;
Measure: Turn off the main power switch.
- If water leaks from the indoor unit.
Measure: Stop the operation.

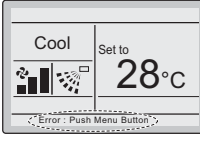
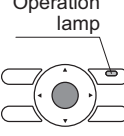
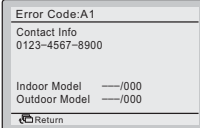
	<ul style="list-style-type: none"> •Screen and the operation lamp will blink. •If a warning occurs, only the error icon will blink and the operation lamp will not blink. •To display the error code and contact information, press the Menu/Enter button. 
	<ul style="list-style-type: none"> •The error code blinks and the contact address and model name will appear. •Notify your Daikin dealer of the Error code and Model name.

11. DISPOSAL REQUIREMENTS



For batteries, a chemical symbol can be printed beneath the symbol. This chemical symbol means that the battery contains a heavy metal above a certain concentration. Possible chemical symbols are:

Pb: lead (>0.004%)

Do not try to dismantle the system yourself: the dismantling of the product, treatment of the refrigerant, of oil and of other parts must be done by a qualified installer in accordance with relevant local and national legislation.

Units and waste batteries must be treated at a specialized treatment facility for re-use, recycling and recovery.

By ensuring correct disposal, you will help to prevent potential negative consequences for the environment and human health.

Please contact the installer or local authority for more information.

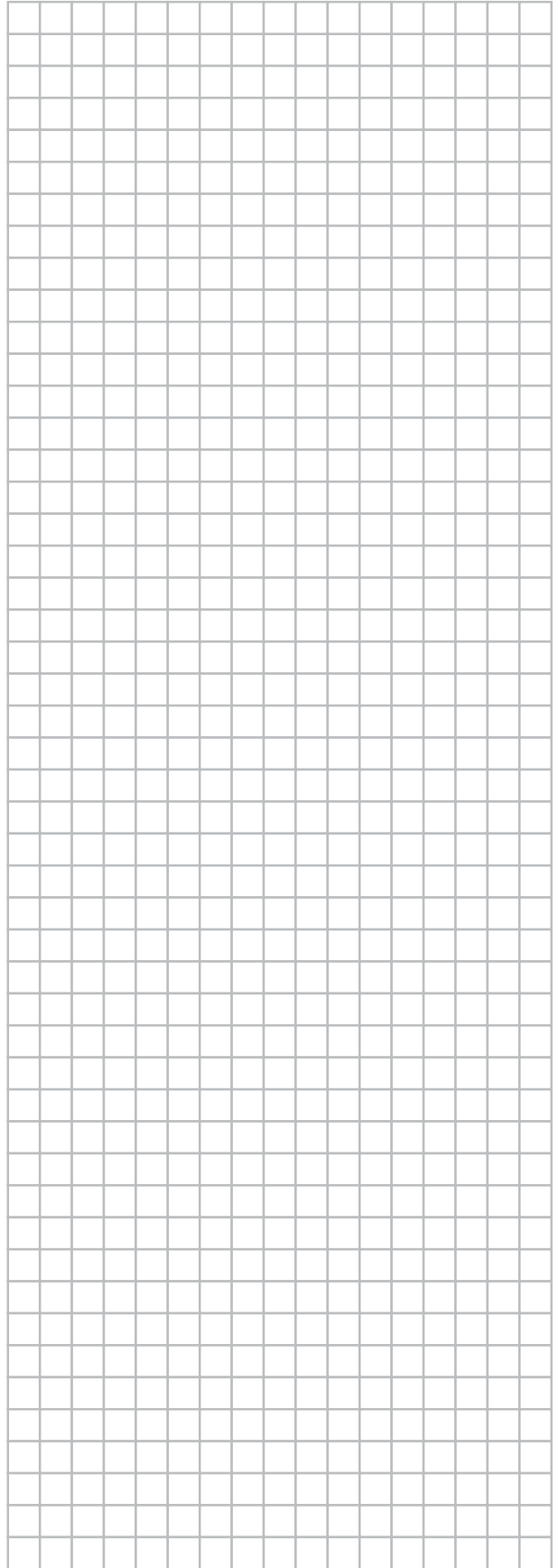
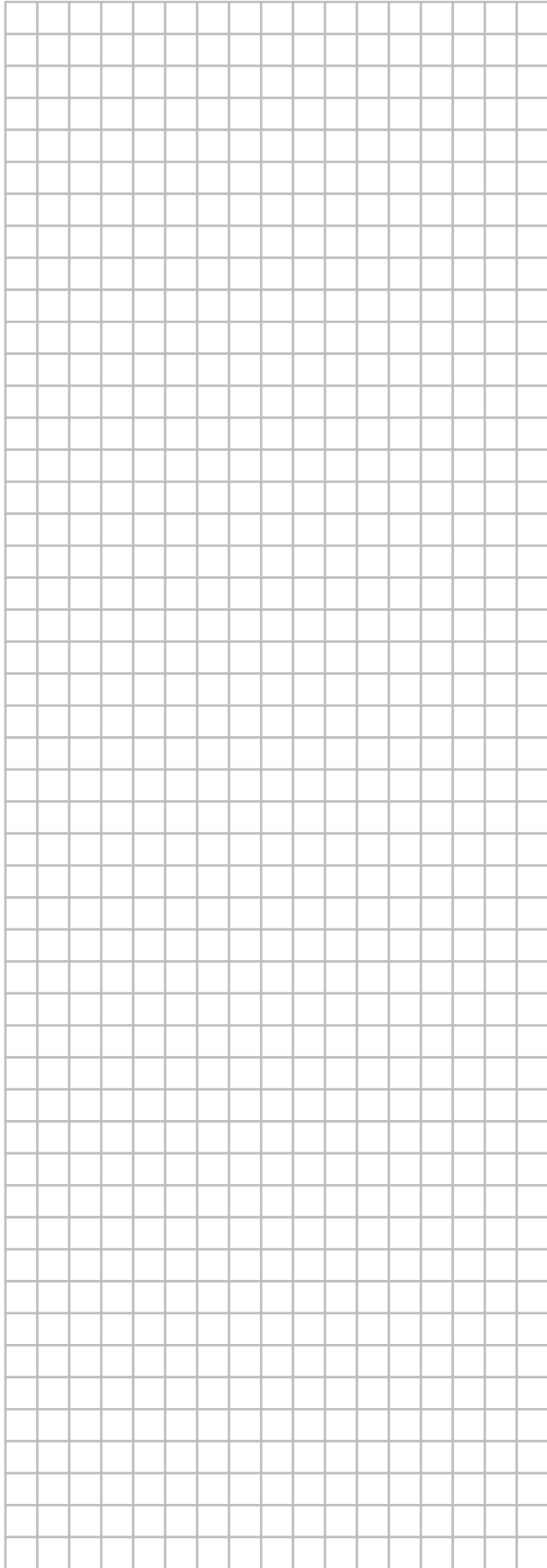

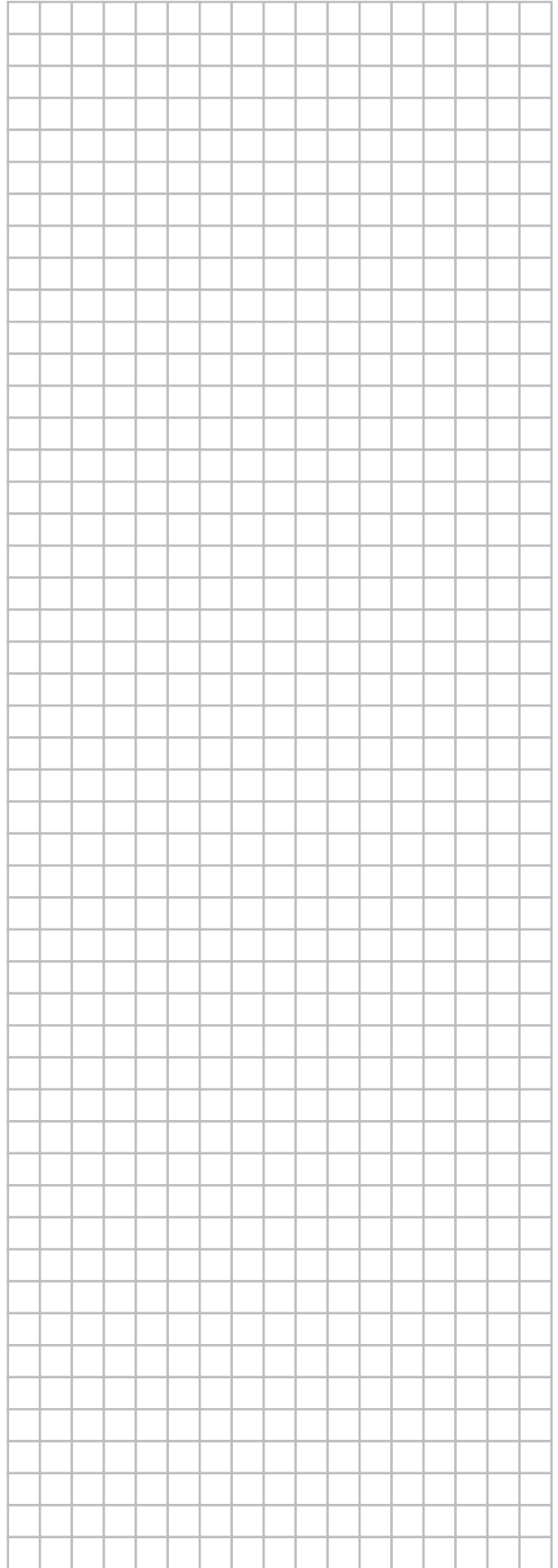
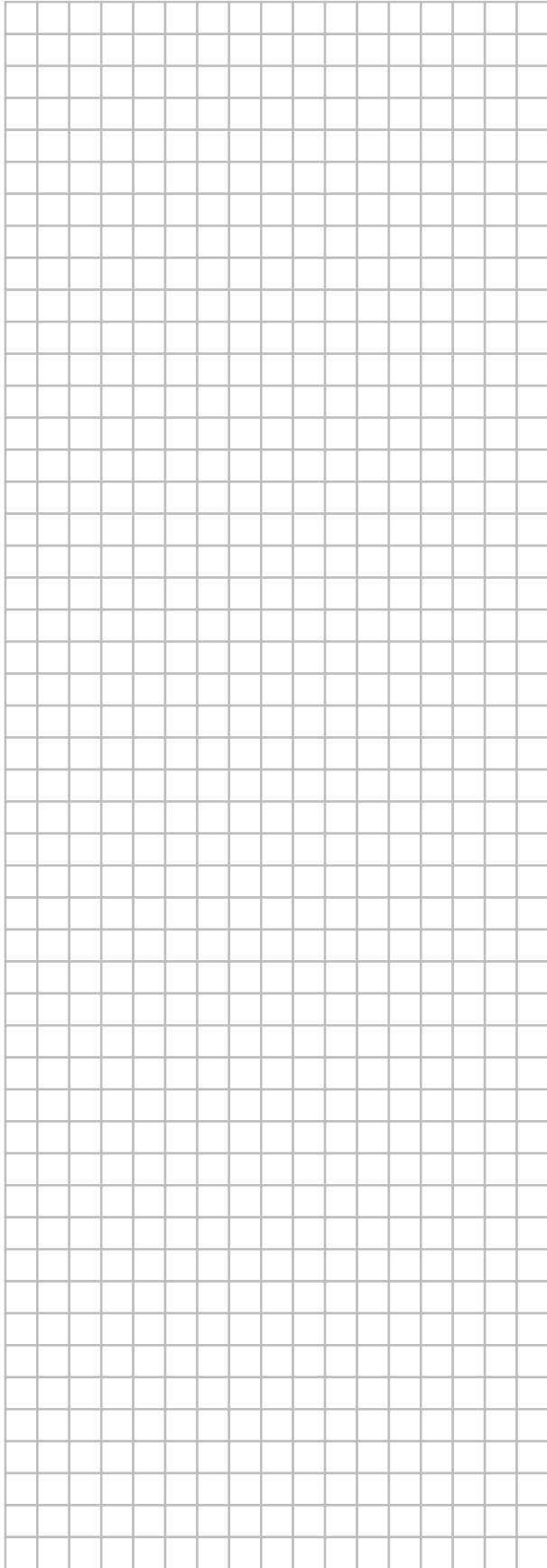

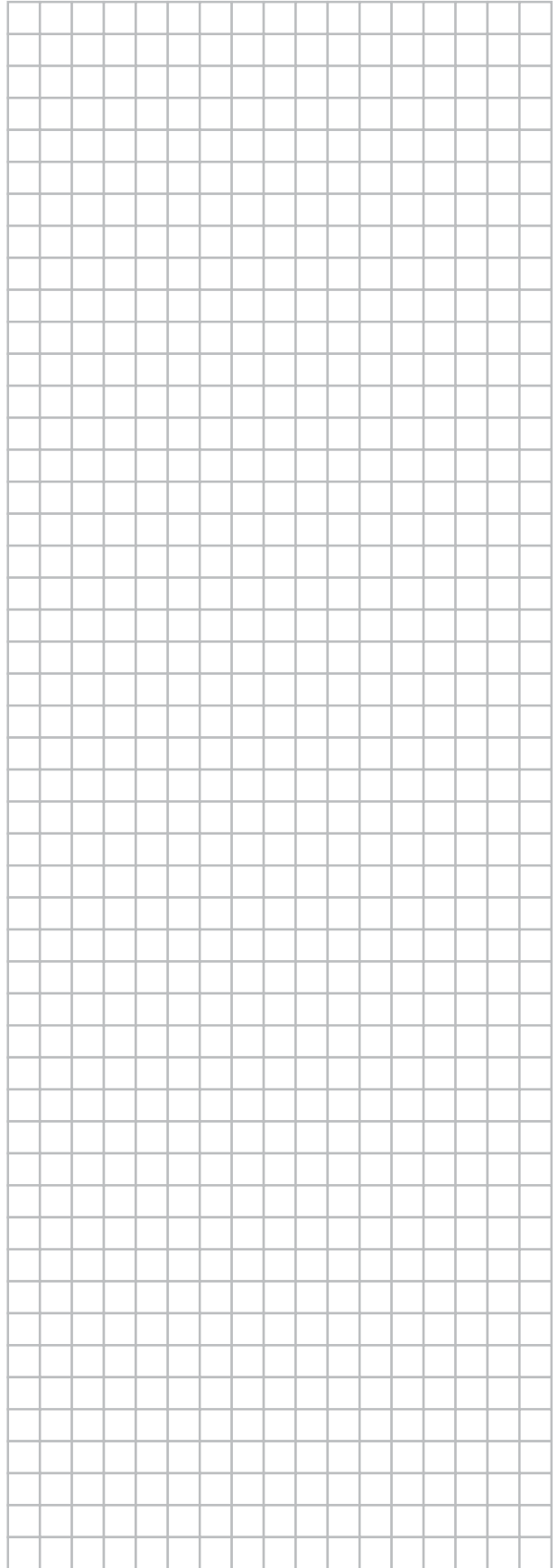
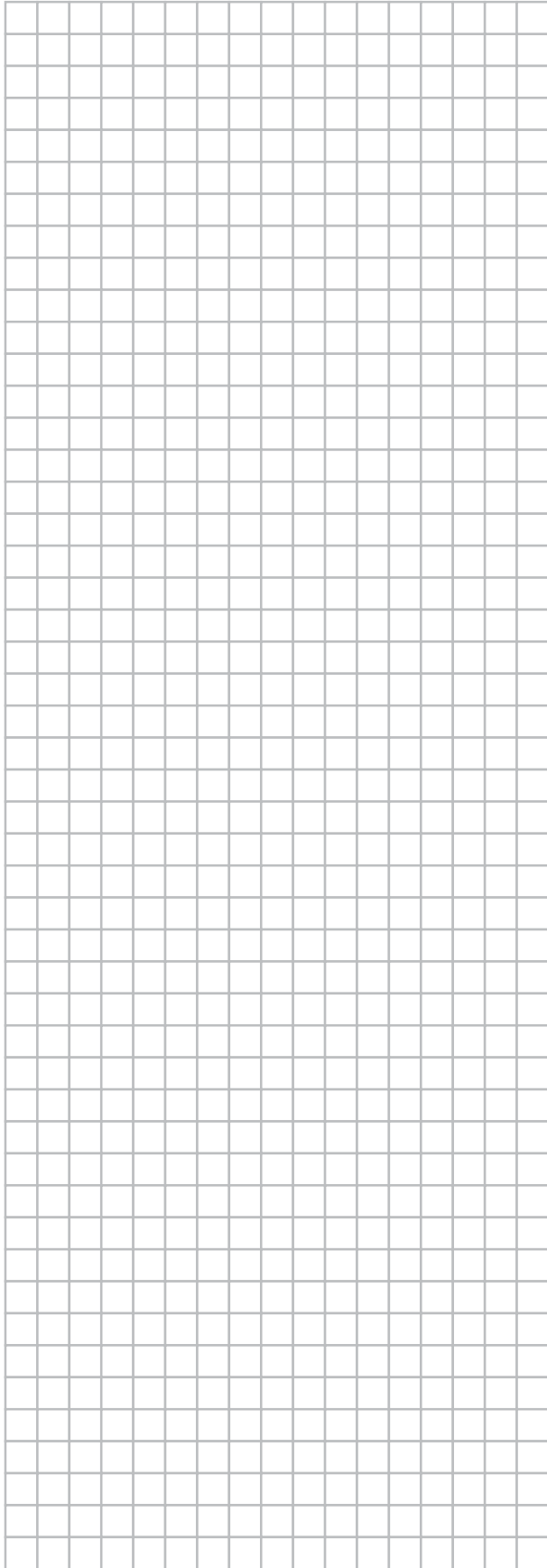

Copyright 2017 Daikin

ERC

4P465543-1 2017.01