

USER'S INFORMATION MANUAL

G17R Series Units

GAS UNITS
502,774M
9/92
Supersedes 502,689M

RETAIN THESE INSTRUCTIONS FOR FUTURE REFERENCE



▲ WARNING

If the information in this manual is not followed exactly, a fire or explosion may result causing property damage, personal injury or loss of life.

Do not store or use gasoline or other flammable vapors and liquids in the vicinity of this or any other appliance.

Installation and service must be performed by a qualified installer, service agency or the gas supplier.

WHAT TO DO IF YOU SMELL GAS:

- Do not try to light any appliance.
- Extinguish any open flames.
- Do not touch any electrical switch; do not use any phone in your building.
- Immediately call your gas supplier from a neighbor's phone. Follow the gas supplier's instructions.
- If you cannot reach your gas supplier, call the fire department.

G17R PARTS IDENTIFICATION

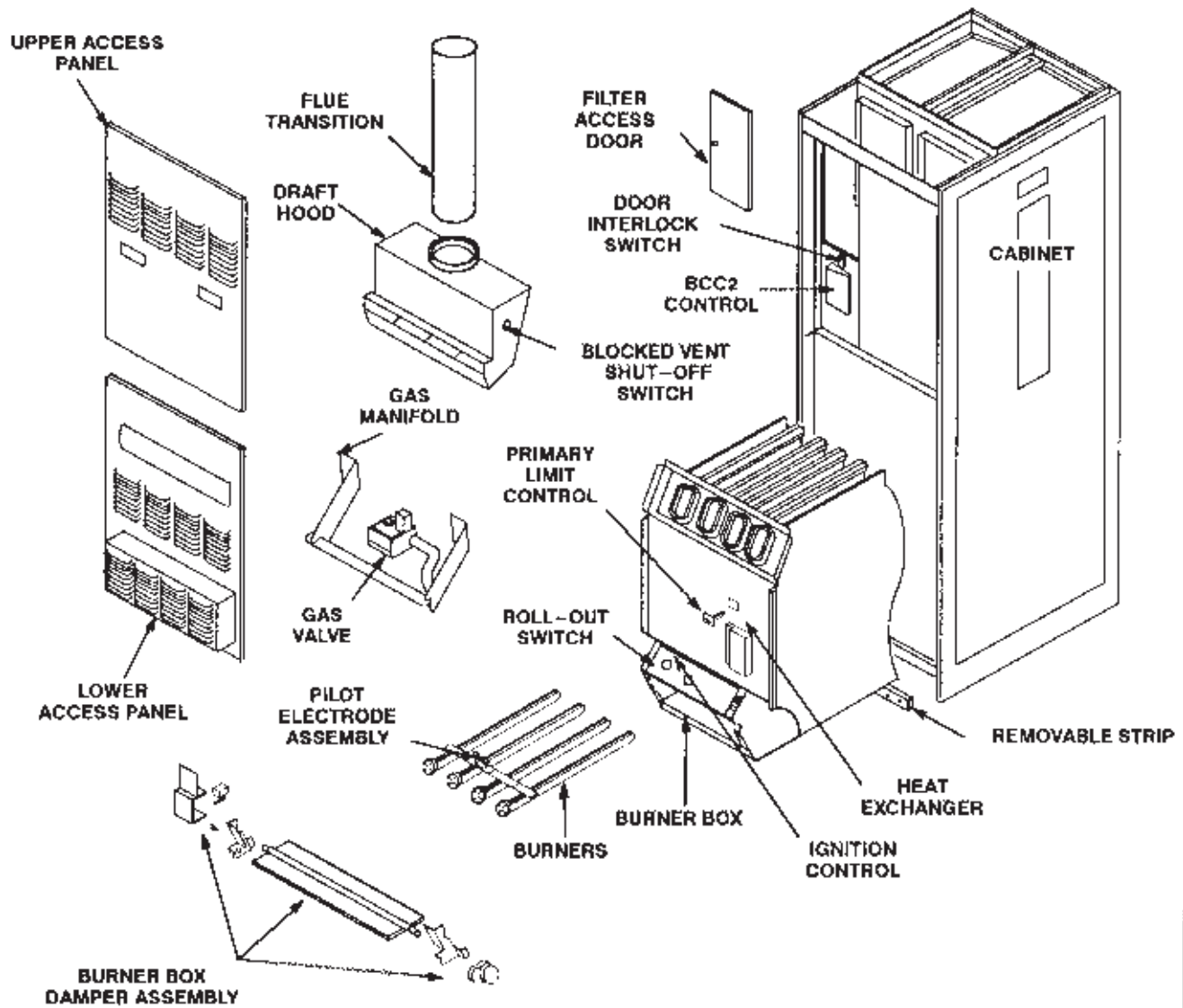

FIGURE 1

⚠ WARNING

Product contains fiberglass wool.

Disturbing the insulation in this product during installation, maintenance, or repair will expose you to fiberglass wool. Breathing this may cause lung cancer. (Fiberglass wool is known to the State of California to cause cancer.)

Fiberglass wool may also cause respiratory, skin, and eye irritation.

To reduce exposure to this substance or for further information, consult material safety data sheets available from address shown below, or contact your supervisor.

Lennox Industries Inc.
P.O. Box 799900
Dallas, TX 75379-9900

⚠ WARNING

If overheating occurs or if gas supply fails to shut off, shut off the manual gas valve to the appliance before shutting off electrical supply.

⚠ WARNING

Do not use this furnace if any part has been underwater. Immediately call a qualified service technician to inspect the furnace and to replace any part of the control system and any gas control which has been under water.

⚠ CAUTION

Before attempting to perform any service or maintenance, turn the electrical power to unit OFF at disconnect switch.

⚠ IMPORTANT

Any additions, changes, or conversions required in order for the appliance to satisfactorily meet the application needs must be made by a Lennox service technician using factory specified and approved parts.

IMPORTANT DIRECTIONS

- 1- Keep the furnace area clear and free of combustible material, gasoline, and other flammable vapors and liquids. If installed in an insulated area, furnace must be kept free of insulating material. Insulating material may be combustible. Inspect furnace venting system to make sure it is in place, physically sound, and without holes, corrosion, or blockage. Inspect furnace return air duct connection to ensure duct is sealed to the furnace and terminates outside the space containing the furnace. Inspect the physical support of the furnace to guarantee that it is sound without sagging, cracks or gaps around base and it maintains a seal between base and support.
- 2- DO NOT obstruct air flow to unit. Unit must receive an unobstructed flow of combustion and ventilating air.
- 3- DO NOT store chlorine or fluorine products near unit or introduce these products into combustion air. These products can cause furnace corrosion.

LIGHTING INFORMATION AND OPERATION

⚠ WARNING

If you do not follow these instructions exactly, a fire or explosion may result causing property damage, personal injury or loss of life.

BEFORE LIGHTING smell all around the appliance area for gas. Be sure to smell next to the floor because some gas is heavier than air and will settle on the floor.

Use only your hand to push in or turn the gas control knob. Never use tools. If the knob will not push in or turn by hand, do not try to repair it, call a qualified service technician. Force or attempted repair may result in a fire or explosion.

To place G17R furnace into operation:

G17R units are equipped with an intermittent pilot ignition system. Do not attempt to manually light pilots on these furnaces. Each time thermostat calls for heat, the pilot will be automatically lit. The pilot does not burn when there is no call for heat on units with electronic ignition.

Gas Valve Operation for Robertshaw 7100DER Series Valve (Figure 3 - 5)

- 1- STOP! Read the safety information at the beginning of this section.
- 2- Set thermostat to lowest setting. See figure 2.
- 3- Turn off all electrical power to appliance.

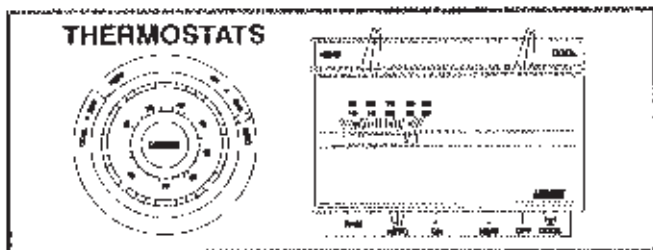

FIGURE 2

- 4- This appliance is equipped with an ignition device which automatically lights the pilot. Do not try to light the pilot by hand.
- 5- Remove lower access panel. See figure 1.
- 6- On Robertshaw 7100D and Honeywell VR8204 gas valves, turn knob on gas valve clockwise to OFF. Units with Robertshaw 7200 gas valve, depress lever and move to OFF position. Do not force. See figures 3 through 5.

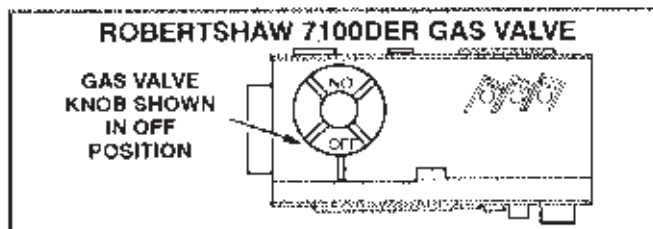

FIGURE 3

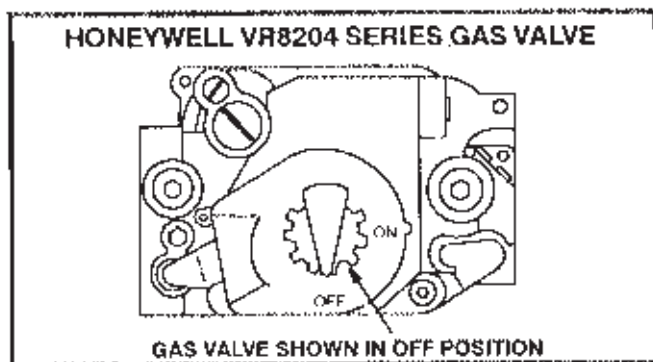

FIGURE 4

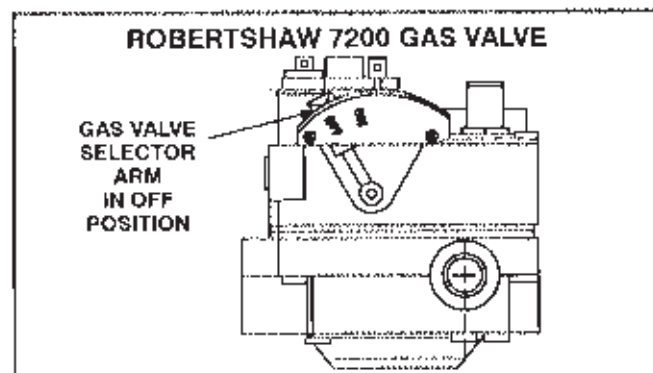

FIGURE 5

7- Wait fifteen (15) minutes to clear out any gas. If you then smell gas, STOP! Immediately call your gas supplier from a neighbor's phone. Follow the gas supplier's instructions. If you do not smell gas go to next step.

8- On Robertshaw 7100D and Honeywell VR8204 gas valves, turn knob on gas valve counterclockwise to ON. Units with Robertshaw 7200 gas valve, depress lever and move to ON position. Do not force.

9- Replace lower access panel.

10-Turn on all electrical power to unit.

11-Set thermostat to desired setting.

NOTE-When unit is initially started, steps 1 through 11 may need to be repeated to purge air from the pilot line.

12-If the appliance still will not operate, follow the instructions "To Turn Off Gas To Unit" and call your service technician or gas supplier.

To Turn Off Gas To Unit:

- 1- Set thermostat to lowest setting.
- 2- Turn off all electrical power to unit if service is to be performed.
- 3- Remove lower access panel.
- 4- On Robertshaw 7100D and Honeywell VR8204 gas valves, turn knob on gas valve clockwise to OFF. Units with Robertshaw 7200 gas valve, depress lever and move to OFF position. Do not force.
- 5- Replace lower access panel.

FILTERS

G17R series units are equipped with two permanent internal filters which should be inspected monthly and cleaned when necessary to assure proper furnace operation. See table 1 for filter sizes. Use the following procedure and figure 6 to clean filter.

TABLE 1

MODEL NO.	FILTER SIZE
Q2/3-50, Q3-75	20 X 10 X 1
Q3/4-100	20 X 12 X 1
Q5-100, Q4/5-125	20 X 14 X 1

- 1- Turn off electrical power to furnace.
- 2- Remove upper access panel.
- 3- Remove filter access door.
- 4- Lift left side filter over left support angle.

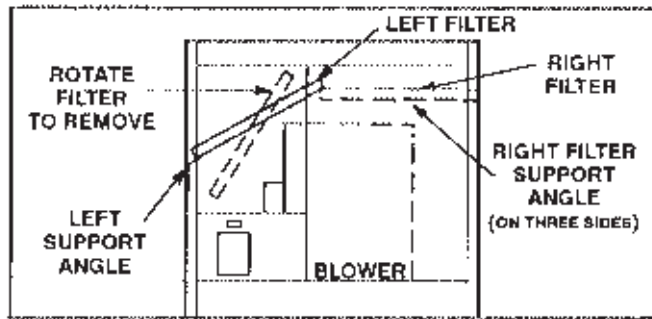

FIGURE 6

- 5- Rotate filter sideways and pull it through the filter access opening.
- 6- Pull the second filter out the same way as the first.
- 7- Wash filters with warm water and mild detergent. When dry, filters should be sprayed with filter handcoater before replacing. Filter Handcoater is RP products coating no. 418 and is available as Lennox part no. P-8-5069.
- 8- Replace filters blower access panel and upper access panel and restore power to unit.
- 9- If necessary, replace filters with permanent filter of like kind and size. DO NOT replace with disposable filter.

BLOWER

Check and clean blower wheel for any debris. Blower motor is prelubricated for extended bearing life. No further lubrication is needed.

PILOT AND BURNER FLAME

CAUTION

Check pilot flame and burner flame periodically to ensure proper operation.

- 1- *Pilot Flame* -- Pilot flame must surround the end of thermocouple for proper operation of pilot safety circuit. See figure 7.

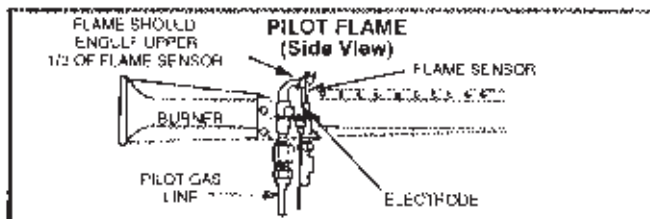

FIGURE 7

- 2- *Burner Flame* -- Start burner and allow to operate for a few minutes to establish normal burning conditions. Check burner flame by observation. Flame should be predominantly blue in color, strong in appearance and

should rise directly from the burner ports in the heat exchanger. Check to see that flame is burning from all continuous ribbon ports and that flame does not strike the sides of the heat exchanger. See figure 8.



FIGURE 8

VENTING SYSTEM INSPECTION

Annually (before heating season) inspect furnace venting system, draft hood, vent cap, heat exchanger, burners and pilot for corrosion, deterioration, or deposits of debris. Remove any obstructions.

Contact your Lennox dealer for a periodic unit inspection by a qualified service technician.

BLOCKED VENT SHUT-OFF SYSTEM

Your Lennox furnace is equipped with a blocked vent shut-off switch and a flame roll-out switch. The blocked vent shut-off switch shuts off the gas supply to the furnace in the event of flue or vent blockage. The flame roll-out switch shuts off the gas supply to the furnace if there is a blockage of the heat exchanger. If the furnace fails to operate due to the functioning of either of these safety switches, DO NOT attempt to place the furnace into operation. Contact a qualified service person.

SERVICE REMINDER

Call your Lennox service technician if unit is inoperative. Before calling, always check the following to be sure service is required.

- 1- Check to see that electrical disconnect switches are ON.
- 2- Check room thermostat for proper setting.
- 3- Replace any blown fuses or reset circuit breakers.
- 4- Gas valve should be ON.
- 5- Air filter should not be plugged limiting air flow.
- 6- Is gas turned on at meter?
- 7- Is manual main shut-off valve open?

PLANNED SERVICE

To keep your Lennox gas heating system in peak operating condition year after year, contact your independent Lennox dealer about a planned service program.