

Измерение давления

1 **2** **3** **4** **5**

позиция 1 = 0 позиция 2 = A

4

Результат измерения в Па

0	1	2	3	4	5
---	---	---	---	---	---

Измеренное давление в Па

5

1 **2** **3** **4** **5**

установить обратно в исходную позицию

4

А В С...

5

3

6

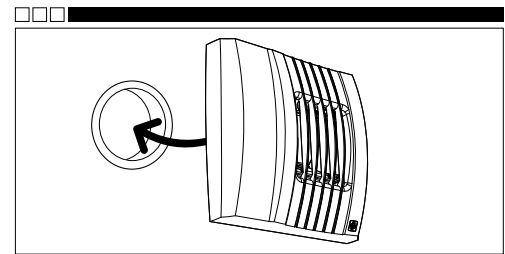

 **aereco**
 Aereco S.A.
 9 allée du Clos des Charmes - Collégien
 77615 Marne la Vallée Cdx 3 - FRANCE
 tel: +33 1 60 06 26 63 - fax: +33 1 60 06 22 11
www.aereco.com

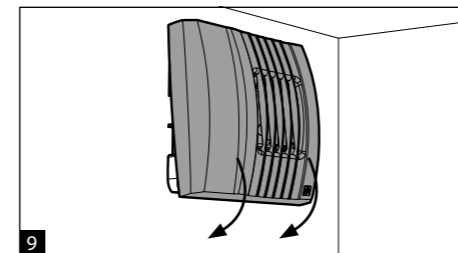
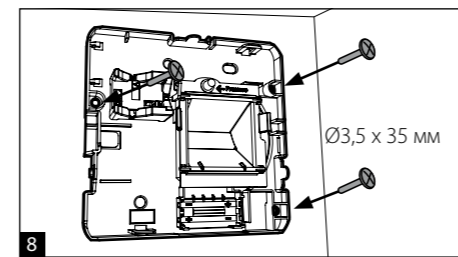
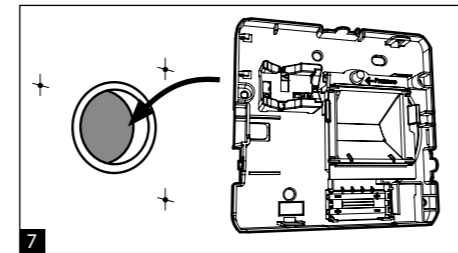
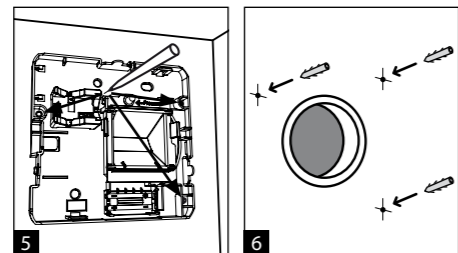
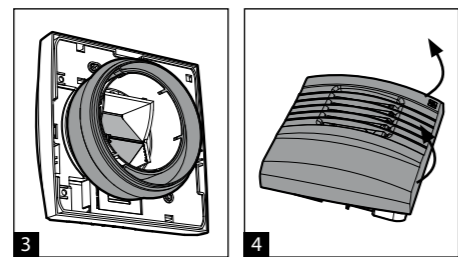
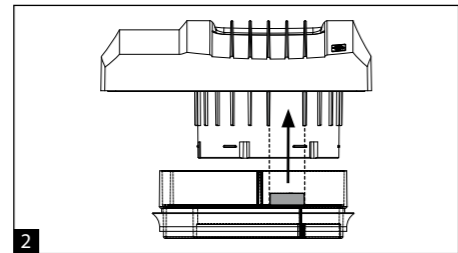
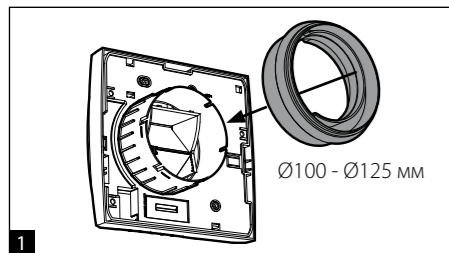
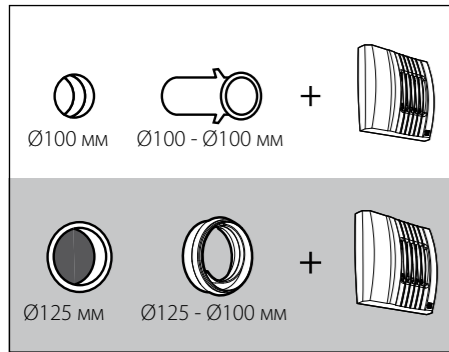
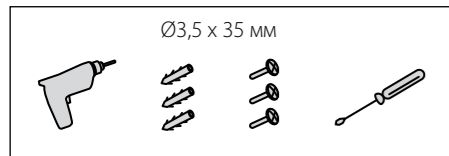

Установка расхода воздуха

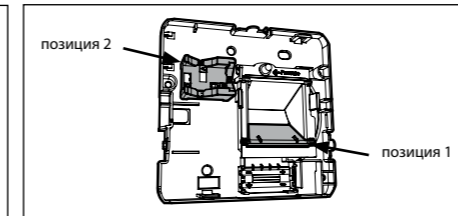

Ø 100 мм

Расход воздуха (м³/ч) при 100 Па		позиция 2		
		A	B	C
позиция 1	0	12	50	80
	1	18	55	90
	2	24	60	100
	3	30	70	110
	4	36	80	120
	5	42	90	130

Ø 125 мм

Расход воздуха (м³/ч) при 100 Па		позиция 2		
		A	B	C
позиция 1	0	12	50	70
	1	18	55	80
	2	24	60	90
	3	30	70	100
	4	36	75	110
	5	42	80	120

