

Data: November 2004

Supersedes: 508B - 04/03 B

Air cooled screw chillers

McPower 228.2÷478.3

Standard Efficiency – Cooling capacity from 760 to 1600 kW

High Efficiency – Cooling capacity from 820 to 1550 kW

50Hz – Refrigerant: HFC 407C

HFC 407C

ECOLOGICAL REFRIGERANT

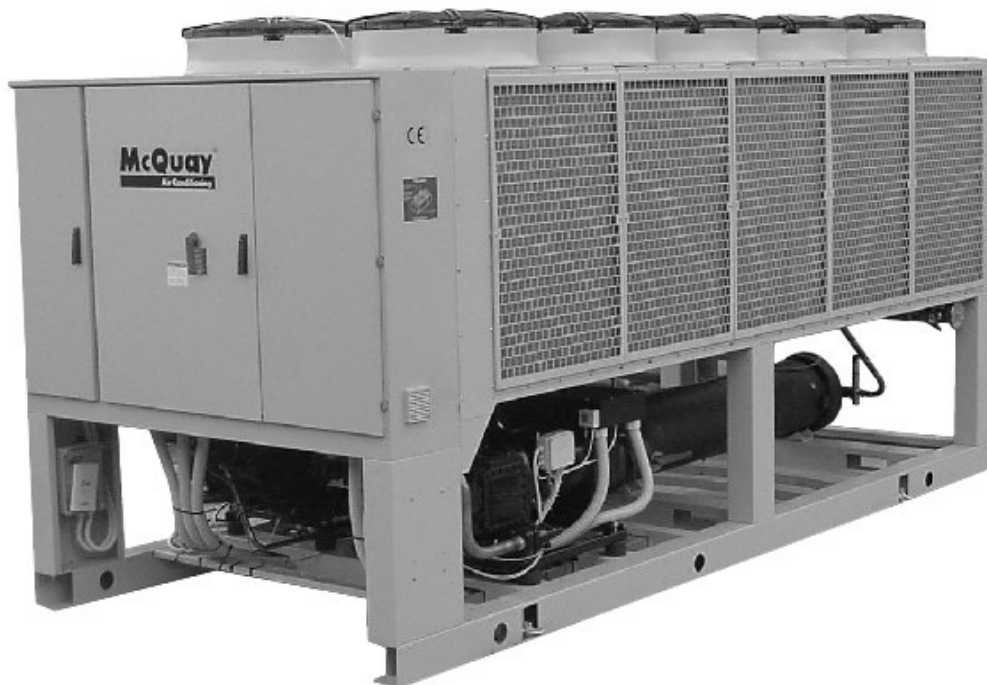

McQuay is participating in the Eurovent Certification Programme. Product are as listed in the Eurovent Directory of Certified Products and on the web site www.eurovent-certification.com

**McQuay**
Air Conditioning

New air cooled screw chillers McQuay McPower

McQuay International introduces its newest air cooled screw chillers equipped with new single screw compressors. McQuay air cooled McPower are a new range of chillers using the last generation of McQuay StarGate™ Frame 4 single screw compressors. They are manufactured by McQuay to satisfy the requirements of the consultants and the end user. McQuay McPower units are designed to minimise energy costs while maximising the refrigeration capacities. Once again McQuay has developed a line of chillers unsurpassed in performance and quality that will meet the most stringent requirements of comfort cooling, ice storage and process applications. McQuay's chiller design experience, combined with outstanding features makes the McPower chiller unmatched in the industry.

Lower noise – higher flexibility

The primary reason for quiet operation is the compressor design itself. McQuay continues the philosophy of a single main rotor with two adjacent twin rotating gaterotors. This allows the possibility to have two compression cycles per main rotor round and so a constant gas flow. This compression process completely eliminates gas pulsations, one of the most important noise source. The oil injection also results in a significant mechanical noise reduction.

The twin gas compressor discharge chambers are designed to act as attenuators, based on the harmonic wave principle with destructive interference, thus always resulting almost equal to zero. Of course also condenser fans are selected for both good performance and low sound levels.

The extremely low noise compressor performance allows the use of McPower chiller for all applications.

Lower Vibration Levels – higher reliability

Because the moving components in the McQuay Single Screw Compressor are purely rotational and the loads are basically balanced, the dynamic forces and vibrations created by the system are very low. This reduced vibration results in less movement to refrigerant lines and other parts of the system.

The extremely low vibration levels, inherent with the single-screw design, will not pass through system piping and allow objectionable resonated sound to be carried into the building.

The reduced level of vibrations produced from the McPower chillers offers a surprisingly quiet operation.

Code requirements

McPower units are designed and manufactured in accordance with applicable selections of the following which are equivalent to American Air-conditioning industry applicable codes:

Rating of chillers: EN 12055.

Construction of pressure vessel: PED, TUV Standards (on request).

Electrical codes: IEC 204-1 CEI 44-5 Elect. & Safety Codes

Safety Codes: CEI-EN 60204–1 Codes.

Manufacturing Quality Stds: ISO 9001:2000.

Infinitely variable capacity control

Cooling capacity control is infinitely variable by means of a capacity slide controlled by microprocessor system. Each unit has infinitely variable capacity control from 100% down to 6.25% (four compressors units), to 8.3% (three compressors units) to 12.5% (two compressors units). This modulation allows the compressor capacity to exactly match the building cooling load without any leaving evaporator water temperature fluctuation. This chilled water temperature fluctuation is avoided only with a stepless control, such as McQuay International has. With a compressor load step control in fact, the compressor capacity, at partial loads, will be or too high or too low compared to the building cooling load. The result is a decrease in chiller energy efficiency, particularly at part-load conditions at which the chiller operates most of the time.

Additionally, thanks to infinitely variable control, in some case there should be the possibility to avoid inertial tank in the water circuit.

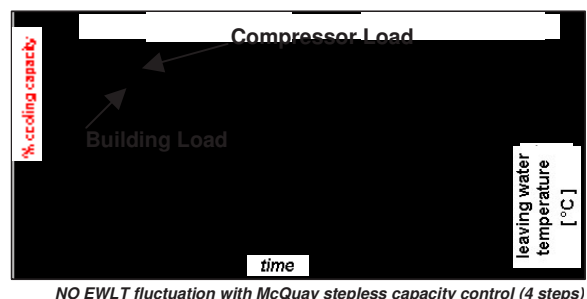
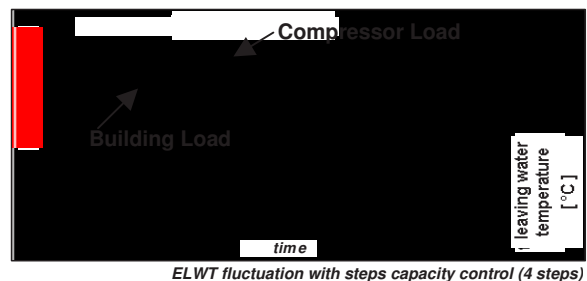

10 different lines

New McPower line is available with two different efficiencies in order to satisfy every kind of requirements. Acoustic flexibility up to 65 dBA thanks to different noise level versions:

- **SE Standard Efficiency** with COP up to **2,45** (nominal condition-only compressor power input).
 - **ST** Standard noise – 80,5 ÷ 81,5 dB(A)
 - **CN** Sound proof cabinet around compressors – 78,5 ÷ 79,5 dB(A)
 - **LN** Low noise – 75,0 ÷ 77,0 dB(A)
 - **XN** Extra low noise – 72,5 ÷ 73,5 dB(A)
 - **XXN** Super quiet – 66,5 ÷ 67,5 dB(A)
- **XE High Efficiency** with COP up to **2,9** (nominal condition-only compressor power input).
 - **ST** Standard noise – 80,5 ÷ 81,5 dB(A)
 - **CN** Sound proof cabinet around compressors – 78,5 ÷ 79,5 dB(A)
 - **LN** Low noise – 75,0 ÷ 77,0 dB(A)
 - **XN** Extra low noise – 72,5 ÷ 73,5 dB(A)
 - **XXN** Super quiet – 66,5 ÷ 67,5 dB(A)

ST – Standard version with additional base frame for compressors and oil separators installed on rubber isolators to eliminate the vibrations.

CN – Standard version with additional base frame for compressors and oil separators installed on rubber isolators to eliminate the vibrations and a compressors sound proof cabinet insulated with highly absorbent acoustical material.

LN – Version with additional base frame for compressors and oil separators installed on rubber isolators to eliminate the vibrations. Discharge flexible pipes and condenser fans rotating at fixed low speed.

XN – The main components are the same of LN version (same cooling capacity) but to reduce the sound level the compressors, the oil separators and delivery and suction pipes are located inside a cabinet which is sound insulated with highly absorbent acoustic material. Discharge flexible pipes and condenser fans rotating at fixed low speed are supplied as standard.

XXN The main components are the same of LN version (same cooling capacity) but to reduce the sound level the compressors, the oil separators and delivery and suction pipes are located inside a cabinet which is sound insulated with highly absorbent acoustic material. Discharge flexible pipes, condenser fans rotating at extremely low speed.

Unmatched serviceability

Field serviceability has not been sacrificed. Inspection covers allows visual inspection of the main screw and gaterotors.

Outstanding reliability features

Unsurpassed Efficiency

- Zero clearance fit between the two gaterotors and main screw rotor virtually eliminates leakage between the high and low-pressure sides during compression. Special gaterotor material made from an advanced composite, temperature stable material makes a zero clearance design possible.
- The McPower air-cooled chiller is equipped with the most advanced means of refrigerant flow control available. An electronic expansion valve coupled with the MicroTech II C Plus controller's control logic provides excellent operating efficiencies both at full and part load operation.
- Infinite unloading matches compressor capacity to load.
- Full factory testing of the unit with water hookups helps provides a trouble-free start-up. Extensive quality control checks during testing means that each equipment protection and operating control is properly adjusted and operates correctly before it leaves the factory. Factory-installed options minimize field expenses and startup labor.

- The rugged design of the single-screw compressor allows it to be tolerant of liquid slugging. McPower screw chiller will start and operate under conditions that would often destroy other compressors.
- Very low loading enhances the bearing and compressor reliability. Due to symmetrical compression taking place on both sides of the main screw rotor, balanced forces result in the elimination of the large radial force loads inherent in twin-screw compressors.
- Integral to the basic design of the single-screw compressor, the main screw rotor shaft and the gaterotor shafts cross at right angles in the compressor. The result is ample space to locate heavy duty bearings and increase compressor reliability since no limitations are placed on bearing design as found in twin-screw compressors.

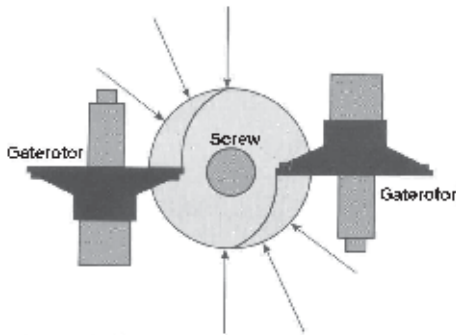

Balanced radial forces

Single Screw Compressor

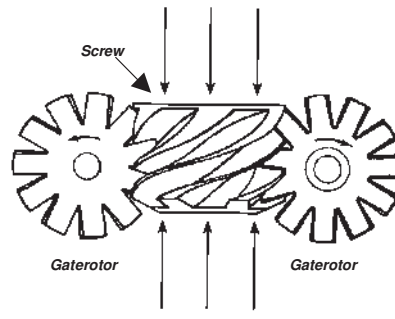

Balanced axial forces

Single Screw Compressor

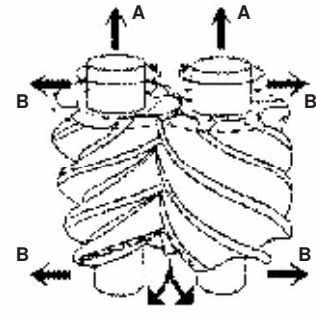

High Axial and Radial thrusts in TwinScrew Compressor

Twin Screw Compressor

General characteristics

Cabinet and structure

The cabinet of McPower units is made of galvanized steel sheet and painted to provide a high resistance to corrosion. The unit base frame has holes to lift the unit with ropes for an easy installation. The weight is uniformly distributed along the profiles of the base and this facilitates the arrangement of the unit. For the units XN & XXN the compressors and the oil separators are located inside a cabinet that is sound insulated in order to reduce their noise.

Screw compressors

The Stargate™ single-screw compressor has a well balanced compression mechanism which cancels the screw rotor load in both the radial and axial directions. Inherent to the basic single-screw compressor design is the virtually load-free operation, that gives main bearing design life of 3-4 times greater than twin-screws, and eliminates expensive and complicated thrust balancing schemes. The two exactly opposed gaterotors create two exactly opposed compression cycles. Compression is made at the lower and upper parts of the screw rotor at the same time, thus cancelling the radial loads. Also, both ends of the screw rotor are subjected to suction pressure only, which cancels the axial loads and eliminates the huge thrust loads inherent in twin-screw compressors (see images and drawings in this page).

Oil injection is used for these compressors in order to get high COP at high condensing pressure. McPower units are provided with an high efficiency oil separator to maximise oil extraction. Compressors have an infinitely variable capacity control down to 25% of its total capacity. This control is made by means of capacity slides controlled by microprocessors.

Standard start is star-delta type; Soft start type is available (as option) in order to have lower inrush current in almost all work conditions and to provide smooth, slow stepless acceleration and controlled slow deceleration reducing mechanical and electrical stress for even greater compressor/motor life.

Ecological HFC 407C refrigerant

McQuay can design and optimize Screw compressors to operate with any kind of HFC fluid refrigerant.

McPower units are designed to operate with ecological refrigerant HFC 407C which has zero ODP (Ozone Depletion Potential) because it contains no Chlorine and low GWP (Global Warming Potential).

This refrigerant is safe and chemically stable and is listed in ASHRAE Standard-34 (*Number Designation and Safety Classification For Refrigerants*) as "A-1" refrigerant: lowest toxicity, non-flammable.

HFC 407C has "Glide". Glide describes the property of a refrigerant boiling across a temperature range at a given pressure (*it is ZEOTROPIC*), rather than a single temperature (*AZEOTROPIC as HFC 134a*).

This ecological refrigerant is a blend of three constituents: 23% of R32, 25% of R125 and 52% of R134a and is zeotropic. At typical water chiller evaporator pressures, R407C has about 5 K of glide.

Evaporator

The units is supplied with new optimised counter-flow evaporator single refrigerant pass that allows a perfect oil circulation and so a perfect oil return to the compressor. "Counter Flow" heat exchanger design takes advantage of the Glide characteristic intrinsic to HFC 407C.(see figure) It is direct expansion with refrigerant inside the tubes and water outside (shell side) with carbon steel tube sheets, with straight copper tubes that are spirally wound internally for higher efficiencies, expanded on the tube plates. The external shell, is linked with an electrical heater to prevent freezing up to -28 C ambient temperature, commanded by a thermostat and is covered with a closed cell insulation material.

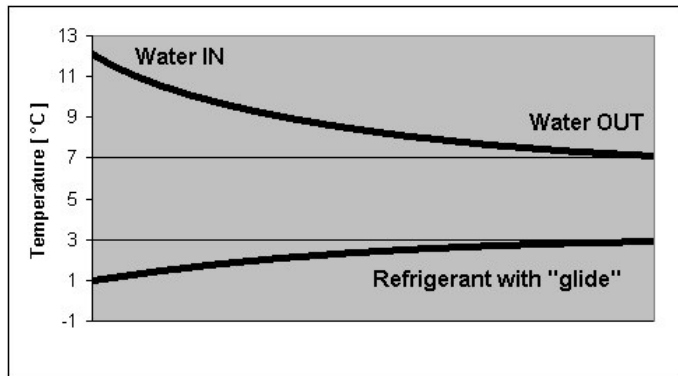

Each evaporator has 2 or 3 circuits, one for each compressor and is manufactured in accordance to PED approval. The evaporator water outlet connections are provided with Victaulic Kit

Chilled Water pump

As option unit can be provided with one or two pumps for the chilled water. The pump is unit mounted and connected to the electrical panel. The pump(s) are centrifugal type with stainless steel impeller.

A diaphragm expansion tank with nitrogen charge is furnished. The terminal connection for water pump's discharge line is Victaulic type. Chiller with two pumps is provided with two shut-off valves on the connection pipes for an easy maintenance.

Condenser coils

The new McPower units are constructed with internally enhanced seamless copper tubes arranged in a staggered row pattern and mechanically expanded into McQuay lanced and rippled aluminium condenser fins with full fin collars. An integral subcooler circuit provides sub-cooling to effectively eliminate liquid flashing and increases in cooling capacity without increasing the power input.

Condenser coil fans

The condenser fans are helical type with wing-profile blades to achieve a better performance. The direct coupling with the electrical motor eliminates any problems with regard to the application of transmission devices reducing vibrations caused by the functioning. The three-phase type motors are supplied as standard with IP54 protection (Insulation class F); they are protected against overloading and short circuits by circuit breakers located inside the electrical control panel.

With this new chiller line (McPower with HFC 407C) McQuay International starts to use a different fan shape (see image on the right). The fans, with their blades, are installed immediately at the top of the condenser coils in a circular baseframe with metal grill. This allows noise reduction on the top side of the chiller and a better performance of the highest condenser tube rows for a consequent higher air velocity. The chiller height doesn't change thanks to a new condenser coil design.

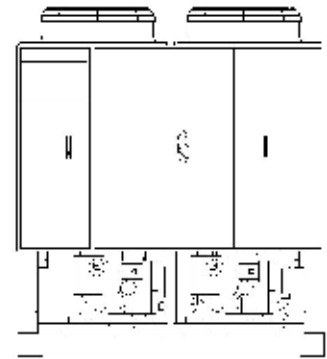

Electronic expansion valve (EEXV)

McPower air cooled chiller is equipped with the most advanced electronic expansion valve to achieve precise control of refrigerant mass flow. As today's system requires improved energy efficiency, tighter temperature control, wider range of operating conditions and incorporate new features like remote monitoring and diagnostics,

the application of electronic expansion valves becomes mandatory. McPower electronic expansion valve proposes features that makes it unique: short opening and closing time, high resolution, positive shut-off function to eliminate use of additional solenoid valve, highly linear flow capacity, continuous modulation of mass flow without stress in the refrigerant circuit and corrosion resistance stainless steel body.

EEXV strength point is the capacity to work with lower DeltaP between high and low pressure side, than a thermostatic expansion valve. The electronic expansion valve allows the system to work with low condenser pressure (winter time) without any refrigerant flow problems and with a perfect chilled water leaving temperature control.

Electrical control panel

Power and control are located into two sections of the main panel that is manufactured to insure protection for all weather conditions.

The power panel is fitted with an interlocked door main isolator to prevent access while power supply is on. Electrical panel is IP54.

Power section includes - The power section includes contactors, all compressors fuses, fans magneto-thermal relays, and control circuit transformer. Additional space is provided for an easy installation of the various optional accessories provided to enhance the McPower units capabilities.

Certifications

All the McPower units are CE marked (89/392). McQuay Italia obtained ISO 9001:2000.

Water content in cooling circuits

The cooled water distribution circuits should have a minimum water content to avoid excessive compressors start and stop.

In fact, each time the compressor starts up, an excessive quantity of oil goes from the compressor sump and simultaneously there is a rise in the temperature of the compressor motor's stator due to the inrush current during the start-up. To prevent damage to the compressors, McQuay has envisaged the application of a device to limit frequent stops and restarts.

During the span of one hour there will be no more than 6 starts of the compressor. The plant side should therefore ensure that the overall water content allows a more constant functioning of the unit and consequently greater environmental comfort. The minimum installation water content envisaged should be calculated with a certain approximation using this simplified formula:

$$(1) \quad Q = 35,83 \times \frac{P \text{ (kW)}}{\Delta T \text{ (}^\circ\text{C)}} \times \frac{1}{N}$$

where:

Q = Minimum content of the plant expressed in litres

P = Cooling capacity of the plant expressed in kW

ΔT = Entering/leaving water temperature difference of the evaporator expressed in $^\circ\text{C}$

N = Number of compressors.

This should be the minimum quantity of water through the chiller in each operating condition, also when thermal hydronic units are switched off.

Therefore for a more accurate determination of the water quantity, it is advisable to contact the designer of the plant.

MicroTech II C Plus controller

MicroTech II C Plus controller is installed as standard on all the units; it can be used to modify unit set points and check control parameters. A display illustrates the machine's operating status, programable values and setpoints e.g. temperatures, and pressures of fluids (water, refrigerant). Device controls maximise the McQuay chillers energy efficiency and reliability characteristics. It uses sophisticated software with predictive logic to select the most energy efficient combination of compressor, EEXV and condenser fan to keep stable operating conditions and maximise energy efficiency. The compressors are automatically rotated to ensure equal operating hours. MicroTech II protects critical components in response to external signals from its system sensors measuring: motor temperatures, refrigerant gas and oil pressures, correct phases sequence and phase loss.

Control section - main features:

- Management of the compressor capacity slide and the EEXV valve according to the distributed multiprocessor logic system
- Chillers enabled to work in partial failure condition thanks to the distributed multiprocessor logic system
- Full routine operation at condition of:
 - High ambient temperature value
 - High thermal load
 - High evaporator entering water temperature (start-up)
- Display of evaporator entering/leaving water temperature
- Display of condensing-evaporating temperature and pressure, suction and discharge superheat temperature for each circuit
- Leaving water cooled temperature regulation. Temperature tolerance $\pm 0,1$ °C
- Compressors and evaporator/condenser pumps hours counter
- Display of Status Safety Devices
- Start up numbers and compressors working hours equalization
- Excellent management of compressors load
- Cooling tower's fans management according to condensing pressure
- Automatic re-start in case of power supply interruption (adjustable)
- Soft Load
- Return Reset
- AOT Reset
- Setpoint Reset
- Demand limit or Current limit (optional)
- Speedtrol control (optional)

Safety for each refrigerant circuit

High pressure (pressure switch)

Low pressure (pressure switch)

Compressor overload (optional)

Condensation fan Magneto-thermal

High Discharge Temperature on the compressor

Phase Monitor

Star / Delta Transition Failed

Low Delta Pressure between Suction and Discharge

Low pressure ratio

High oil pressure drop

Low oil pressure

System security

Phase monitor

Freeze protection

An evaporator's flow controller input (stops the unit)

Remote on/off input.

Regulation type

Proportional + integral + derivative regulation on the input probe of the evaporator water leaving temperature.

Condensation

The condensation can be carried out according to temperature or pressure. The fans can be managed according to ON/OFF mode or with a 0/10 V modulating signal.

MicroTech II C Plus terminal

The MicroTech II C Plus terminal has following features:

- 4-lines by 20-character liquid crystal display back lighted
- Key-pad consisting of 15 keys " clear language display "
- Memory to protect the data
- General faults alarm led
- 4-level password access to modify the setting
- Service report displaying all running hours and general conditions
- Memorized alarm history to facilitate the fault's analysis.

MicroPlant™:

Solution for: tele-maintenance and supervisory systems

MicroTech II C Plus can be monitored locally or via modem by MicroPlant™ supervision program, that runs on PC systems under Windows '95 – '98.

MicroPlant™ is the best solution:

- To centralise all the information in just one local and/or remote PC
- To check all the parameters for each unit connected
- Data logging of temperature - pressure
- Printouts of alarms, parameters and graphs
- To control several plants located in different geographical areas from a central station
- To manage the Service centers

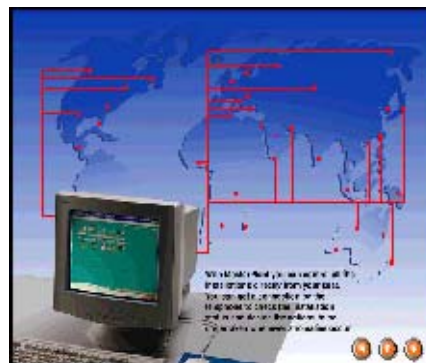

MicroPlant™ allows:

- Visualization of all working conditions for each controller
- Visualization of their graphics
- Display, print-out of the actual alarms
- Connection between local and remote computer via telephone line (Modem)
- Units ON / OFF
- Set point change.

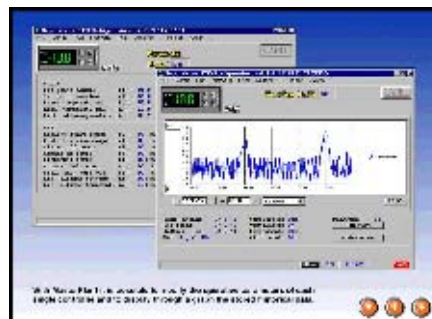

MicroTech II C Plus remote control

Compatibility with supervisory systems is becoming increasingly important in HVAC. MicroTech II C Plus allows easy interfacing with BMS (Building Management Systems), the external world that can be:

- Full compatible Siemens, Johnson;
- Every MODBUS compatible system;
(Satchwell, Honeywell)
- BacNet point to point, ECHELON FTT10
(available on request)

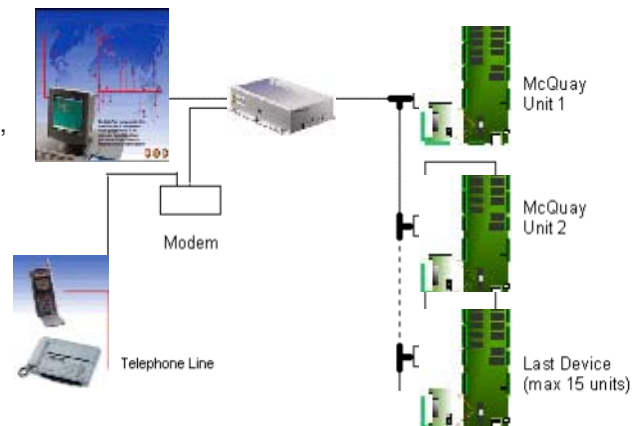

Standard Accessories (furnished on basic unit)

Star Delta Compressors starter – For low inrush current and reduced starting torque.

Thermal relays fans – Safety devices against fans motor overloading.

Phase monitor – The phase monitor controls that phases sequence is correct and controls the phase loss.

Evaporator electric heater – Electric heater controlled by a thermostat to protect the evaporator from freezing down to -28°C ambient temperature.

Evaporator connection water side Victaulic – Hydraulic joint with gasket for an easy and quick water connection.

Alarm from external device – Microprocessor is able to receive an alarm signal from an external device (pump etc...). User can decide if this alarm signal will stop or not the unit.

General fault relay – Contactor for the alarm warning.

Discharge line shut off valves.

Options (on request)

100% total heat recovery (R) – Produced with shell and tube heat exchangers to obtain hot water up to +55° C. The heat exchangers are installed on the refrigerant circuits in parallel to the condenser coils, to remove all the condensation heat.

25% partial heat recovery (D) – Produced with plate to plate heat exchangers installed between the compressor discharge and the condenser coil. Hot water can be produced up to a maximum temperature of +55°C.

Compressor thermal overload relays – Safety devices against compressor motor overloading in addition to the normal protection envisaged by the electrical windings.

Ammeter and voltmeter - Digital meters of unit drawn amperes and voltage values, installed on the electrical control panel.

Absorbed Current Limit / Display – This options allows to monitor the chiller absorbed current with possibility to set a limit value. This option excludes the Demand Limit.

Condenser power factor correction - Installed on the electrical control panel to ensure it conforms to the plant rules. (McQuay advices maximum 0,9).

100 Pa lift fans – For all the applications where a higher fans lift is required (not available for LN, XN, XXN versions and not compatible with fan speed modulation options).

250 Pa lift fans – For all the applications where a higher fans lift is required (not available for LN, XN, XXN versions and not compatible with fan speed modulation options).

Fan speed control device - This device allows the continuous variation of the fan speed, modifying the air flow according to the external temperature conditions. It allows the unit working with air temperature down to -18°C.

Fan Silent Mode - The microprocessor clock switches the fan at low speed according to the client setting (i.e. Night & Day), providing that the ambient temperature/condensing pressure is allowing the speed change. It allows a perfect condensing control down to -18°C

Speedtrol – Continuous fan speed modulation on the first fan of each circuit. It allows the unit working with air temperature down to -20°C .

Condenser coil guards - Metal protection guards fixed on all the external surface of the condenser coils.

Evaporator area guards – Metal protection guards around evaporator area.

Cu-Cu condensing coils - To give better protection against corrosion by aggressive environments.

Cu-Cu-Sn condensing coils - To give better protection against corrosion in aggressive environments and by salty air.

Alucoat condensing coils - Fins are protected by a special acrylic paint with a high resistance to corrosion.

20mm thicked evaporator insulation – Useful in really heavy operating conditions.

Flow switch - Supplied separately to be wired and installed on the evaporator water piping (by the customer).

Suction line shut off valve – Suction shut-off valve installed on the suction port of the compressor to facilitate maintenance operation.

Spreader bars - Facilitate the lifting of the units keeping the ropes away from the unit's casing.

Rubber type antivibration mounts - Supplied separately. Ideal to reduce the vibrations when the unit is floor mounted.

Witness tests - The units are normally tested at the test bench prior to the shipment. On request, a second test can be carried out, at customer's presence, in accordance with the procedures indicated on the test form. (Not available for units with Glycol mixtures).

Soft start – Electronic starting device to reduce inrush current. An overload protection is included (no need of compressors thermal relays).

Over / Under Voltage – Phase monitor to control the minimum and maximum voltage value.

Water circulation pump – The pump is unit mounted. Hydronic kit consists of: one centrifugal pump direct driven, expansion tank, water feed circuit with pressure gauge, safety valve. The pump motor is protected by a circuit breaker installed in control panel. The kit is assembled and wired to the control panel.

Two water circulation pumps – Pumps units are unit mounted. Hydronic kit consists of: two centrifugal pumps direct driven, expansion tank, water feed circuit with pressure gauge, safety valve, check valves, shut-off valves. The pumps motors are protected by circuit breakers installed in control panel. The kit is assembled and wired to the control panel.

Note: Spring type isolators (usually used with reciprocating chillers) are not recommended for McPower chiller because McQuay Frame 4 screw compressors do not generate low frequency vibrations.

Installation notes

Handling

Care should be taken to avoid rough handling or shock due to dropping the unit. Do not push or pull the unit from anything other than the base, and block the pushing vehicle away from the unit to prevent damage to the cabinet. Never allow the unit fall during unloading or moving as this may result in serious damage. To lift the unit, holes are provided in the base of the unit. Spreader bar and cables should be arranged to prevent damage to the condenser coil or unit cabinet.

Location

McPower units are produced for outside installation on roofs, floors or below ground level on condition that the area is free from obstacles for the passage of the condenser air. The unit should be positioned on solid foundations and perfectly level; in the case of installation on roofs or floors, it may be advisable to arrange the use of suitable weight distribution beams. When the units are installed on the ground, a concrete base at least 250 mm wider and longer than the unit's footprint should be laid. Furthermore, this base should withstand the unit weight mentioned in the technical data table. When the units are positioned in areas which are easily accessible by persons or animals, it is advisable to fit guards to protect the condenser coil guards and, when necessary, also guards to protect the evaporator area.

Space requirements

McPower units are air-cooled, hence it is important to observe the minimum distances which guarantee the best ventilation of the condenser coils. Limitations of space reducing the air flow could cause significant reductions in cooling capacity and an increase in electricity consumption.

To determinate unit placement, careful consideration must be given to assure a sufficient air flow across the condenser heat transfer surface. Two conditions must be avoided to achieve the best performance: warm air recirculation and coil starvation.

Both these conditions cause an increase of condensing pressures that results in reductions in unit efficiency and capacity. McPower chiller performance is less affected in poor air flow situations because of its special condensing coil geometry.

Moreover McQuay's unique microprocessor has the ability to calculate the operating environment of the chiller and the capacity to optimize its performance staying on-line during abnormal conditions.

Each side of the unit must be accessible after installation for periodic service. Fig.1 shows you minimum recommended clearance requirements.

Vertical condenser air discharge must be unobstructed because the unit would have its capacity and efficiency significantly reduced.

If the units are positioned in places surrounded by walls or obstacles of the same height as the units, the units should be at least 2500 mm from obstacles (fig.2). In the event the obstacles are higher than the units, the units should be at least 3000 mm from the obstacle (fig.4). Units installed closer than the minimum recommended distance to a wall or other vertical riser may experience a combination of coil starvation and warm air recirculation, thus causing reduction in unit capacity and efficiency reductions. Once again, the microprocessor will allow the chiller to stay on line, producing the maximum available capacity, even at less than recommended lateral clearances.

When two or more units are positioned side by side it is recommended that the condenser coils are at least 3600 mm distance from one another (fig.3); strong wind could be the cause of air warm recirculation.

For other installation solutions, consult McQuay technicians.

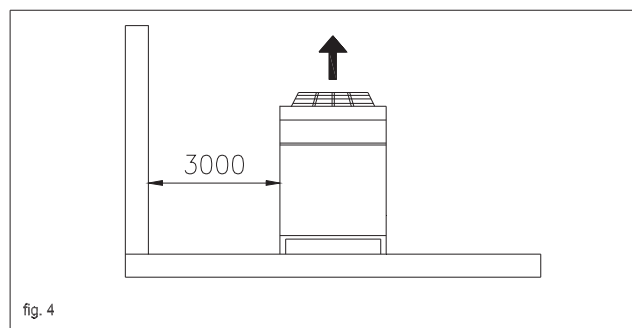
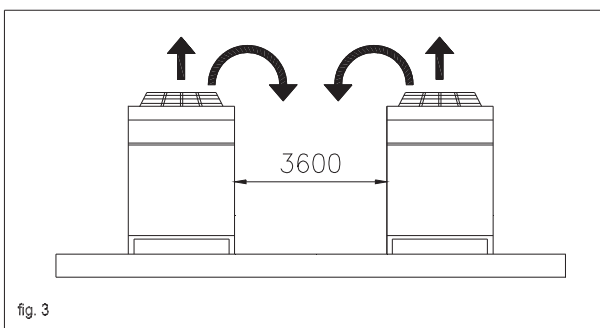
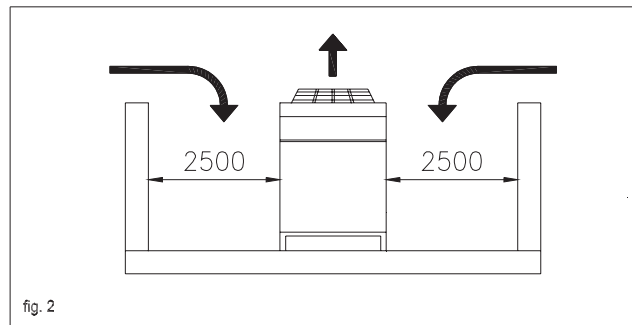
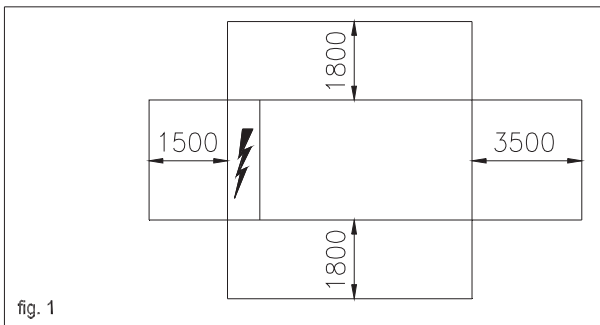

Acoustic protection

The low noise levels of the McPower units means that they meet the most restrictive regulations, thanks to the availability of four versions with different sound levels. When the noise level must meet special requirements it will be necessary to pay the maximum attention to ensure the perfect insulation of the unit from the support base by applying appropriate vibration-dampening devices, applying vibration-dampening mounts on the water pipes and on the electrical connections.

Table 1 – Operating limits – McPower SE

Unit version		ST	LN	XN	XXN
Max ambient temperature (1)	°C	42	38	38	35
Min ambient temperature	°C	+10 (2)	+10 (2)	+10 (2)	+10 (2)
Max leaving evaporator water temperature	°C	+10	+10	+10	+10
Min leaving evap. water temp.(without glycol)	°C	+4	+4	+4	+4
Min leaving evap. water temp.(with glycol)	°C	-8	-8	-8	-8
Max evaporator ΔT	°C	6	6	6	6
Min evaporator ΔT	°C	4	4	4	4

Note: (1) Max ambient temperature are referred to units working at full load. With higher temperatures the chillers will unloading

(2) When air temperature is lower then +10°C you need the fan speed control device. It allows the unit working with air temperature down to -18°C.

Table 2 – Operating limits – McPower XE

Unit version		ST	LN	XN	XXN
Max ambient temperature	°C	46	42	42	40
Min ambient temperature	°C	+10 (2)	+10 (2)	+10 (2)	+10 (2)
Max leaving evaporator water temperature	°C	+10	+10	+10	+10
Min leaving evap. water temp.(without glycol)	°C	+4	+4	+4	+4
Min leaving evap. water temp.(with glycol)	°C	-8	-8	-8	-8
Max evaporator ΔT	°C	6	6	6	6
Min evaporator ΔT	°C	4	4	4	4

Note: (1) Max ambient temperature are referred to units working at full load. With higher temperatures the chillers will unloading

(2) When air temperature is lower then +10°C you need the fan speed control device. It allows the unit working with air temperature down to -18°C.

Table 3 – Evaporator fouling factors

Fouling factors m ² °C / kW	Cooling capacity correction factor	Power input correction factor	COP correction factor
0,0176	1,000	1,000	1,000
0,0440	0,978	0,986	0,992
0,0880	0,957	0,974	0,983
0,1320	0,938	0,962	0,975

Table 4 – Altitude correction factors

Elvation above sea level (m)	0	300	600	900	1200	1500	1800
Barometric pressure (mbar)	1013	977	942	908	875	843	812
Cooling cap.correction factor	1,000	0,993	0,986	0,979	0,973	0,967	0,960
Power input correction factor	1,000	1,005	1,009	1,015	1,021	1,026	1,031

Table 5 – Ethylene glycol and low ambient temperature correction factors

Air ambient temperature °C	-3	-8	-15	-23	-35
% of ethylene glycol by weight	10	20	30	40	50
Cooling capacity correction factor	0,991	0,982	0,972	0,961	0,946
Power input correction factor	0,996	0,992	0,986	0,976	0,966
Flow rate correction factor	1,013	1,040	1,074	1,121	1,178
Water pressure drops correction factor	1,070	1,129	1,181	1,263	1,308

Table 6 – Low temperature operation performance factors

Ethylene glycol/water leaving temperature °C	2	0	-2	-4	-6	-8
Max air ambient temperature °C (SE-ST)	40	39	38	37	36	35
Max air ambient temperature °C (XE-ST)	44	43	42	41	40	39
Cooling capacity correction factor	0,842	0,785	0,725	0,670	0,613	0,562
Power input compressors correction factor	0,95	0,94	0,92	0,89	0,87	0,84
Min. % of ethylene glycol	10	20	20	30	30	30

Low temperature operation performance factors must be applied to the nominal performance data to have the adjusted value (12/7°C, design ambient temperature).

Nomenclature

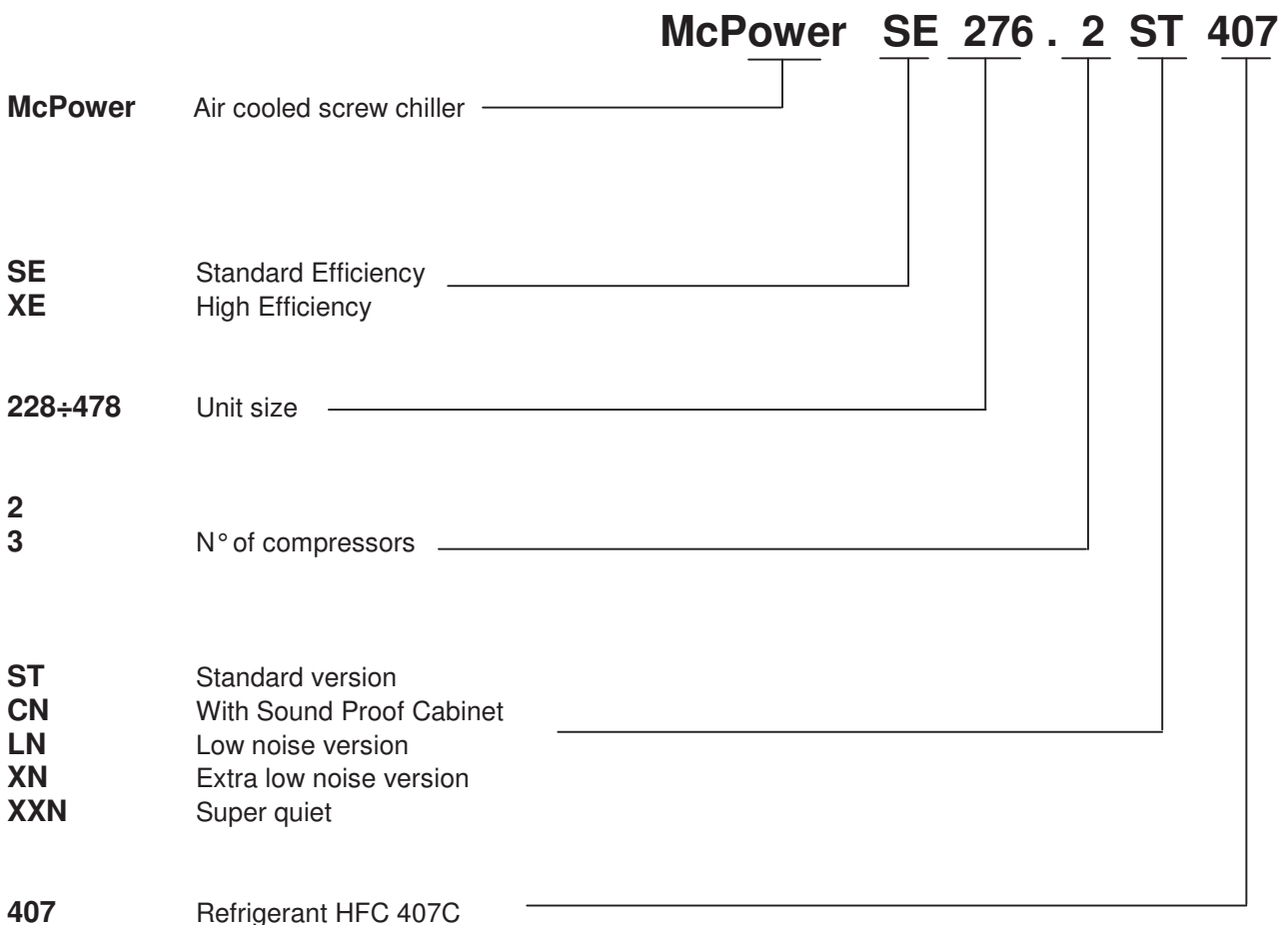

Physical data McPower SE ST and SE CN with HFC 407C

McPower unit size		228.2	255.2	276.2	300.2	320.2	340.3
Cooling capacity (1)	kW	790,4	875,0	943,6	1026,1	1091,9	1158,0
Power input (1)	kW	317,0	348,2	376,9	412,4	444,8	471,2
COP		2,49	2,51	2,50	2,49	2,45	2,46
McQuay singlescrew compressors	N°	2	2	2	2	2	3
Refrigerant circuits	N°	2	2	2	2	2	3
Refrigerant charge	kg	120	130	140	150	160	180
Oil charge	l	28	28	28	28	28	28
Min % of capacity reduction	%	12,5	12,5	12,5	12,5	12,5	8,3

Condenser fans

N° of fans / Nominal power fan	kW	12/2	13/2	14/2	15/2	16/2	18/2
Fan speed	rpm	860	860	860	860	860	860
Diameter	mm	800	800	800	800	800	800
Total air flow	m ³ /s	66,3	71,9	77,4	82,9	88,4	99,5

Evaporator

Evaporator / Water volume	N°/l	1 / 278	1 / 271	1 / 271	1 / 256	1 / 256	1 / 263
Max operating pressure	bar	10,5	10,5	10,5	10,5	10,5	10,5
Water connections diameter	mm	219	219	219	219	219	219

Condenser coil

Coil type	Lanced fins – Internally spiral wound tubes						
-----------	---	--	--	--	--	--	--

Weight and dimension

Standard unit shipping weight for unit ST	kg	5165	5425	5555	5795	5905	7990
Standard unit operating weight for unit ST	kg	5430	5710	5840	6070	6180	8270
Standard unit shipping weight for unit CN	kg	5405	5665	5795	6035	6145	8350
Standard unit operating weight for unit CN	kg	5670	5950	6080	6310	6420	8630
Unit length	mm	6210	7110	7110	8010	8010	9170
Unit width	mm	2230	2230	2230	2230	2230	2230
Unit height	mm	2520	2520	2520	2520	2520	2520

McPower unit size		374.3	395.3	418.3	445.3	464.3	478.3
Cooling capacity (1)	kW	1284,2	1353,5	1426,3	1516,3	1583,0	1649,8
Power input (1)	kW	509,1	537,9	564,5	604,3	636,8	669,4
COP		2,52	2,52	2,53	2,51	2,49	2,46
McQuay singlescrew compressors	N°	3	3	3	3	3	3
Refrigerant circuits	N°	3	3	3	3	3	3
Refrigerant charge	kg	190	200	210	220	230	240
Oil charge	l	28	28	28	28	28	28
Min % of capacity reduction	%	8,3	8,3	8,3	8,3	8,3	8,3

Condenser fans

N° of fans / Nominal power fan	kW	19/2	20/2	22/2	22/2	23/2	24/2
Fan speed	rpm	860	860	860	860	860	860
Diameter	mm	800	800	800	800	800	800
Total air flow	m ³ /s	105	110,6	124	121,6	127,2	132,7

Evaporator

Evaporator / Water volume	N°/l	1 / 432	1 / 432	1 / 432	1 / 419	1 / 419	1 / 419
Max operating pressure	bar	10,5	10,5	10,5	10,5	10,5	10,5
Water connections diameter	mm	273	273	273	273	273	273

Condenser coil

Coil type	Lanced fins – Internally spiral wound tubes						
-----------	---	--	--	--	--	--	--

Weight and dimension

Standard unit shipping weight for unit ST	kg	8305	8435	8890	8905	9155	9265
Standard unit operating weight for unit ST	kg	8775	8905	9360	9350	9600	9710
Standard unit shipping weight for unit CN	kg	8665	8795	9250	9265	9515	9625
Standard unit operating weight for unit CN	kg	9135	9265	9720	9710	9960	10070
Unit length	mm	10070	10070	10970	10970	11870	11870
Unit width	mm	2230	2230	2230	2230	2230	2230
Unit height	mm	2520	2520	2520	2520	2520	2520

Note: (1) Nominal cooling capacity and power input are based on: 12 / 7 °C entering / leaving evaporator water temperature; 35°C ambient temperature. The power input is for compressor only.

Electrical data McPower SE ST and SE CN with HFC 407C

McPower unit size		228.2	255.2	276.2	300.2	320.2	340.3
Standard voltage (1)		400 V – 3f – 50 Hz					
Nominal unit current (2)	A	517	561	673	729	780	796
Max compressor current (3)	A	599	651	711	773	832	891
Fans current	A	48	52	56	60	64	72
Max unit current (3)	A	647	703	767	833	896	963
Max unit inrush current (4)	A	1050	1054	1116	1120	1165	1265
Max unit current for wires sizing (5)	A	668	728	788	848	908	1002

McPower unit size		374.3	395.3	418.3	445.3	464.3	478.3
Standard voltage (1)		400 V – 3f – 50 Hz					
Nominal unit current (2)	A	823	864	1012	1070	1122	1173
Max compressor current (3)	A	950	1002	1064	1134	1193	1251
Fans current	A	76	80	88	88	92	96
Max unit current (3)	A	1026	1082	1152	1222	1285	1347
Max unit inrush current (4)	A	1248	1344	1402	1405	1489	1491
Max unit current for wires sizing (5)	A	1062	1122	1186	1242	1302	1362

- Notes:** (1) Allowed voltage tolerance $\pm 10\%$. Voltage unbalance between phases must be within $\pm 3\%$.
 (2) Nominal current are based on: 12/7 °C entering/leaving evaporator water temperature and 35°C ambient temp.
 (3) Maximum current are based on: 14/9 °C entering/leaving evaporator water temperature and 42°C ambient temp.
 (4) Inrush current of biggest compressor + 75 % of nominal absorbed current of the other compressor + fans current.
 (5) Compressor FLA + fans current.

Physical data McPower SE LN and SE XN with HFC 407C

McPower unit size		228.2	255.2	276.2	300.2	320.2	340.3
Cooling capacity (1)	kW	743,7	822,1	887,1	963,2	1025,0	1091,9
Power input (1)	kW	351,8	385,1	415,6	455,2	491,5	523,0
COP		2,11	2,13	2,13	2,12	2,09	2,09
McQuay singlescrew compressors	N°	2	2	2	2	2	3
Refrigerant circuits	N°	2	2	2	2	2	3
Refrigerant charge	kg	120	130	140	150	160	180
Oil charge	l	28	28	28	28	28	28
Min % of capacity reduction	%	12,5	12,5	12,5	12,5	12,5	8,3

Condenser fans

N° of fans / Nominal power fan	kW	12/1,25	13/1,25	14/1,25	15/1,25	16/1,25	18/1,25
Fan speed	rpm	680	680	680	680	680	680
Diameter	mm	800	800	800	800	800	800
Total air flow	m ³ /s	48,4	52,4	56,5	60,5	64,5	72,6

Evaporator

Evaporator / Water volume	N°/l	1 / 278	1 / 271	1 / 271	1 / 256	1 / 256	1 / 263
Max operating pressure	bar	10,5	10,5	10,5	10,5	10,5	10,5
Water connections diameter	mm	219	219	219	219	219	219

Condenser coil

Coil type	Lanced fins – Internally spiral wound tubes						
-----------	---	--	--	--	--	--	--

Weight and dimension

Standard unit shipping weight for unit LN	kg	5165	5425	5555	5795	5905	7990
Standard unit operating weight for unit LN	kg	5430	5710	5840	6070	6180	8270
Standard unit shipping weight for unit XN	kg	5405	5665	5795	6035	6145	8350
Standard unit operating weight for unit XN	kg	5670	5950	6080	6310	6420	8630
Unit length	mm	6210	7110	7110	8010	8010	9170
Unit width	mm	2230	2230	2230	2230	2230	2230
Unit height	mm	2520	2520	2520	2520	2520	2520

McPower unit size		374.3	395.3	418.3	445.3	464.3	478.3
Cooling capacity (1)	kW	1205,8	1271,3	1346,1	1422,1	1484,7	1547,4
Power input (1)	kW	563,5	594,2	618,5	666,7	703,2	739,7
COP		2,14	2,14	2,18	2,13	2,11	2,09
McQuay singlescrew compressors	N°	3	3	3	3	3	3
Refrigerant circuits	N°	3	3	3	3	3	3
Refrigerant charge	kg	190	200	210	220	230	240
Oil charge	l	28	28	28	28	28	28
Min % of capacity reduction	%	8,3	8,3	8,3	8,3	8,3	8,3

Condenser fans

N° of fans / Nominal power fan	kW	19/1,25	20/1,25	22/1,25	22/1,25	23/1,25	24/1,25
Fan speed	rpm	680	680	680	680	680	680
Diameter	mm	800	800	800	800	800	800
Total air flow	m ³ /s	76,7	80,7	90,9	88,8	92,8	96,8

Evaporator

Evaporator / Water volume	N°/l	1 / 432	1 / 432	1 / 432	1 / 419	1 / 419	1 / 419
Max operating pressure	bar	10,5	10,5	10,5	10,5	10,5	10,5
Water connections diameter	mm	273	273	273	273	273	273

Condenser coil

Coil type	Lanced fins – Internally spiral wound tubes						
-----------	---	--	--	--	--	--	--

Weight and dimension

Standard unit shipping weight for unit LN	kg	8305	8435	8890	8905	9155	9265
Standard unit operating weight for unit LN	kg	8775	8905	9360	9350	9600	9710
Standard unit shipping weight for unit XN	kg	8665	8795	9250	9265	9515	9625
Standard unit operating weight for unit XN	kg	9135	9265	9720	9710	9960	10070
Unit length	mm	10070	10070	10970	10970	11870	11870
Unit width	mm	2230	2230	2230	2230	2230	2230
Unit height	mm	2520	2520	2520	2520	2520	2520

Note: (1) Nominal cooling capacity and power input are based on: 12 / 7 °C entering / leaving evaporator water temperature 35 °C ambient temperature. The power input is for compressor only.

Electrical data McPower SE LN and SE XN with HFC 407C

McPower unit size		228.2	255.2	276.2	300.2	320.2	340.3
Standard voltage (1)		400 V – 3f – 50 Hz					
Nominal unit current (2)	A	566	615	705	766	823	842
Max compressor current (3)	A	620	675	726	782	842	921
Fans current	A	28	30	32	34	37	41
Max unit current (3)	A	648	705	758	816	879	962
Max unit inrush current (4)	A	1048	1050	1104	1106	1154	1270
Max unit current for wires sizing (5)	A	648	706	764	822	881	971

McPower unit size		374.3	395.3	418.3	445.3	464.3	478.3
Standard voltage (1)		400 V – 3f – 50 Hz					
Nominal unit current (2)	A	902	947	1053	1125	1182	1238
Max compressor current (3)	A	978	1040	1069	1147	1207	1266
Fans current	A	44	46	51	51	53	55
Max unit current (3)	A	1022	1086	1120	1198	1260	1316
Max unit inrush current (4)	A	1265	1354	1386	1393	1484	1482
Max unit current for wires sizing (5)	A	1030	1088	1149	1205	1263	1321

- Notes:** (1) Allowed voltage tolerance $\pm 10\%$. Voltage unbalance between phases must be within $\pm 3\%$.
 (2) Nominal current are based on: 12/7 °C entering/leaving evaporator water temperature and 35°C ambient temp.
 (3) Maximum current are based on: 14/9 °C entering/leaving evaporator water temperature and 38°C ambient temp.
 (4) Inrush current of biggest compressor + 75 % of nominal absorbed current of the other compressor + fans current.
 (5) Compressor FLA + fans current.

Physical data McPower SE XXN HFC 407C

McPower unit size		228.2	255.2	276.2	300.2	320.2	340.3
Cooling capacity (1)	kW	708,5	782,7	845,0	916,2	975,0	1042,1
Power input (1)	kW	379,6	414,1	445,7	488,7	528,1	564,5
COP		1,87	1,89	1,90	1,87	1,85	1,85
McQuay singlescrew compressors	N°	2	2	2	2	2	3
Refrigerant circuits	N°	2	2	2	2	2	3
Refrigerant charge	kg	120	130	140	150	160	180
Oil charge	l	28	28	28	28	28	28
Min % of capacity reduction	%	12,5	12,5	12,5	12,5	12,5	8,3

Condenser fans

N° of fans / Nominal power fan	kW	12/0,77	13/0,77	14/0,77	15/0,77	16/0,77	18/0,77
Fan speed	rpm	500	500	500	500	500	500
Diameter	mm	800	800	800	800	800	800
Total air flow	m ³ /s	41,1	44,5	47,9	51,4	54,8	61,7

Evaporator

Evaporator / Water volume	N°/l	1 / 278	1 / 271	1 / 271	1 / 256	1 / 256	1 / 263
Max operating pressure	bar	10,5	10,5	10,5	10,5	10,5	10,5
Water connections diameter	mm	219	219	219	219	219	219

Condenser coil

Coil type	Lanced fins – Internally spiral wound tubes						
-----------	---	--	--	--	--	--	--

Weight and dimension

Standard unit shipping weight	kg	5405	5665	5795	6035	6145	8350
Standard unit operating weight	kg	5670	5950	6080	6310	6420	8630
Unit length	mm	6210	7110	7110	8010	8010	9170
Unit width	mm	2230	2230	2230	2230	2230	2230
Unit height	mm	2520	2520	2520	2520	2520	2520

McPower unit size		374.3	395.3	418.3	445.3	464.3	478.3
Cooling capacity (1)	kW	1147,3	1210,3	1288,2	1352,3	1411,7	1471,1
Power input (1)	kW	606,5	638,3	659,4	715,4	755,1	794,7
COP		1,89	1,90	1,95	1,89	1,87	1,85
McQuay singlescrew compressors	N°	3	3	3	3	3	3
Refrigerant circuits	N°	3	3	3	3	3	3
Refrigerant charge	kg	190	200	210	220	230	240
Oil charge	l	28	28	28	28	28	28
Min % of capacity reduction	%	8,3	8,3	8,3	8,3	8,3	8,3

Condenser fans

N° of fans / Nominal power fan	kW	19/0,77	20/0,77	22/0,77	22/0,77	23/0,77	24/0,77
Fan speed	rpm	500	500	500	500	500	500
Diameter	mm	800	800	800	800	800	800
Total air flow	m ³ /s	65,1	68,5	77,4	75,4	78,8	82,2

Evaporator

Evaporator / Water volume	N°/l	1 / 432	1 / 432	1 / 432	1 / 419	1 / 419	1 / 419
Max operating pressure	bar	10,5	10,5	10,5	10,5	10,5	10,5
Water connections diameter	mm	273	273	273	273	273	273

Condenser coil

Coil type	Lanced fins – Internally spiral wound tubes						
-----------	---	--	--	--	--	--	--

Weight and dimension

Standard unit shipping weight	kg	8665	8795	9250	9265	9515	9625
Standard unit operating weight	kg	9135	9265	9720	9710	9960	10070
Unit length	mm	10070	10070	10970	10970	11870	11870
Unit width	mm	2230	2230	2230	2230	2230	2230
Unit height	mm	2520	2520	2520	2520	2520	2520

Note: (1) Nominal cooling capacity and power input are based on: 12 / 7 °C entering / leaving evaporator water temperature; 35°C ambient temperature. The power input is for compressor only..

Electrical data McPower SE XXN HFC 407C

McPower unit size		228.2	255.2	276.2	300.2	320.2	340.3
Standard voltage (1)		400 V – 3f – 50 Hz					
Nominal unit current (2)	A	606	659	738	805	866	902
Max compressor current (3)	A	614	668	717	783	842	913
Fans current	A	18	20	21	23	24	27
Max unit current (3)	A	632	688	738	806	866	940
Max unit inrush current (4)	A	1053	1055	1106	1108	1157	1286
Max unit current for wires sizing (5)	A	638	696	753	811	868	957

McPower unit size		374.3	395.3	418.3	445.3	464.3	478.3
Standard voltage (1)		400 V – 3f – 50 Hz					
Nominal unit current (2)	A	966	1014	1095	1180	1242	1304
Max compressor current (3)	A	979	1029	1062	1147	1207	1268
Fans current	A	29	30	33	33	35	36
Max unit current (3)	A	1008	1059	1095	1180	1242	1297
Max unit inrush current (4)	A	1288	1373	1389	1400	1501	1496
Max unit current for wires sizing (5)	A	1015	1072	1131	1187	1245	1302

- Notes:** (1) Allowed voltage tolerance $\pm 10\%$. Voltage unbalance between phases must be within $\pm 3\%$.
(2) Nominal current are based on: 12/7 °C entering/leaving evaporator water temperature and 35°C ambient temp.
(3) Maximum current are based on: 14/9 °C entering/leaving evaporator water temperature and 35°C ambient temp.
(4) Inrush current of biggest compressor + 75 % of nominal absorbed current of the other compressor + fans current.
(5) Compressor FLA + fans current.

Physical data McPower XE ST and XE CN with HFC 407C

McPower unit size		228.2	255.2	276.2	300.2	320.2	340.3
Cooling capacity (1)	kW	854,1	954,2	1027,8	1123,9	1195,7	1252,7
Power input (1)	kW	288,2	321,1	350,7	386,3	418,4	428,8
COP		2,96	2,97	2,93	2,91	2,86	2,92
McQuay singlescrew compressors	N°	2	2	2	2	2	3
Refrigerant circuits	N°	2	2	2	2	2	3
Refrigerant charge	kg	160	170	180	190	200	240
Oil charge	l	28	28	28	28	28	28
Min % of capacity reduction	%	12,5	12,5	12,5	12,5	12,5	8,3

Condenser fans

N° of fans / Nominal power fan	kW	16/2	17/2	18/2	19/2	20/2	24/2
Fan speed	rpm	860	860	860	860	860	860
Diameter	mm	800	800	800	800	800	800
Total air flow	m ³ /s	88,5	94	99,5	105	110,6	132,7

Evaporator

Evaporator / Water volume	N°/l	1 / 271	1 / 256	1 / 256	1 / 270	1 / 270	1 / 278
Max operating pressure	bar	10,5	10,5	10,5	10,5	10,5	10,5
Water connections diameter	mm	219	219	219	219	219	219

Condenser coil

Coil type	Lanced fins – Internally spiral wound tubes						
-----------	---	--	--	--	--	--	--

Weight and dimension

Standard unit shipping weight for unit ST	kg	5900	6170	6290	6525	6645	9050
Standard unit operating weight for unit ST	kg	6185	6440	6560	6780	6900	9320
Standard unit shipping weight for unit CN	kg	6140	6410	6530	6765	6885	9410
Standard unit operating weight for unit CN	kg	6425	6680	6800	7020	7140	9680
Unit length	mm	8010	8910	8910	9810	9810	11870
Unit width	mm	2230	2230	2230	2230	2230	2230
Unit height	mm	2520	2520	2520	2520	2520	2520

McPower unit size		374.3	395.3	418.3	445.3	464.3 (2)	478.3 (2)
Cooling capacity (1)	kW	1357,1	1427,1	1497,1	1594,7	1644,4	1729,1
Power input (1)	kW	461,9	490,7	519,3	555,2	598,4	617,8
COP		2,94	2,91	2,88	2,87	2,75	2,80
McQuay singlescrew compressors	N°	3	3	3	3	3	3
Refrigerant circuits	N°	3	3	3	3	3	3
Refrigerant charge	kg	250	260	270	280	290	300
Oil charge	l	28	28	28	28	28	28
Min % of capacity reduction	%	8,3	8,3	8,3	8,3	8,3	8,3

Condenser fans

N° of fans / Nominal power fan	kW	25/2	26/2	28/2	28/2	29/2	30/2
Fan speed	rpm	860	860	860	860	860	860
Diameter	mm	800	800	800	800	800	800
Total air flow	m ³ /s	138,2	143,7	157,8	154,8	160,3	165,8

Evaporator

Evaporator / Water volume	N°/l	1 / 432	1 / 432	1 / 432	1 / 419	1 / 419	1 / 419
Max operating pressure	bar	10,5	10,5	10,5	10,5	10,5	10,5
Water connections diameter	mm	273	273	273	273	273	273

Condenser coil

Coil type	Lanced fins – Internally spiral wound tubes						
-----------	---	--	--	--	--	--	--

Weight and dimension

Standard unit shipping weight for unit ST	kg	9505	9625	10060	10075	10410	10470
Standard unit operating weight for unit ST	kg	9980	10100	10530	10520	10860	10920
Standard unit shipping weight for unit CN	kg	9865	9985	10420	10435	10770	10830
Standard unit operating weight for unit CN	kg	10340	10460	10890	10880	11220	11280
Unit length	mm	12770	12770	13670	13670	14570	14570
Unit width	mm	2230	2230	2230	2230	2230	2230
Unit height	mm	2520	2520	2520	2520	2520	2520

Note: (1) Nominal cooling capacity and power input are based on: 12 / 7 °C entering / leaving evaporator water temperature; 35°C ambient temperature. The power input is for compressor only.

(2) Unit XE 464.3 and XE 478.3 are longer than 14000 mm so beware of special transportation required.

Electrical data McPower XE ST and XE CN with HFC 407C

McPower unit size		228.2	255.2	276.2	300.2	320.2	340.3
Standard voltage (1)		400 V – 3f – 50 Hz					
Nominal unit current (2)	A	477	523	652	707	757	710
Max compressor current (3)	A	596	655	710	777	840	888
Fans current	A	64	68	72	76	80	96
Max unit current (3)	A	660	723	782	853	920	984
Max unit inrush current (4)	A	1051	1055	1125	1129	1172	1259
Max unit current for wires sizing (5)	A	684	744	804	864	924	1026

McPower unit size		374.3	395.3	418.3	445.3	464.3	478.3
Standard voltage (1)							
Nominal unit current (2)	A	756	796	972	1023	1078	1121
Max compressor current (3)	A	948	1002	1056	1123	1184	1245
Fans current	A	100	104	112	112	112	120
Max unit current (3)	A	1048	1106	1168	1235	1296	1365
Max unit inrush current (4)	A	1232	1332	1406	1407	1486	1489
Max unit current for wires sizing (5)	A	1086	1146	1210	1266	1322	1386

- Notes:** (1) Allowed voltage tolerance $\pm 10\%$. Voltage unbalance between phases must be within $\pm 3\%$.
(2) Nominal current are based on: 12/7 °C entering/leaving evaporator water temperature and 35°C ambient temp.
(3) Maximum current are based on: 14/9 °C entering/leaving evaporator water temperature and 46°C ambient temp.
(4) Inrush current of biggest compressor + 75 % of nominal absorbed current of the other compressor + fans current.
(5) Compressor FLA + fans current.

Physical data McPower XE LN and XE XN with HFC 407C

McPower unit size		228.2	255.2	276.2	300.2	320.2	340.3
Cooling capacity (1)	kW	818,2	911,3	981,1	1069,8	1137,3	1202,1
Power input (1)	kW	311,5	346,9	378,6	418,0	453,6	463,4
COP		2,63	2,63	2,59	2,56	2,51	2,59
McQuay singlescrew compressors	N°	2	2	2	2	2	3
Refrigerant circuits	N°	2	2	2	2	2	3
Refrigerant charge	kg	160	170	180	190	200	240
Oil charge	l	28	28	28	28	28	28
Min % of capacity reduction	%	12,5	12,5	12,5	12,5	12,5	8,3

Condenser fans

N° of fans / Nominal power fan	kW	16/1,25	17/1,25	18/1,25	19/1,25	20/1,25	24/1,25
Fan speed	rpm	680	680	680	680	680	680
Diameter	mm	800	800	800	800	800	800
Total air flow	m ³ /s	64,5	68,6	72,6	76,7	80,7	96,8

Evaporator

Evaporator / Water volume	N°/l	1 / 271	1 / 256	1 / 256	1 / 270	1 / 270	1 / 278
Max operating pressure	bar	10,5	10,5	10,5	10,5	10,5	10,5
Water connections diameter	mm	219	219	219	219	219	219

Condenser coil

Coil type	Lanced fins – Internally spiral wound tubes						
-----------	---	--	--	--	--	--	--

Weight and dimension

Standard unit shipping weight for unit LN	kg	5900	6170	6290	6525	6645	9050
Standard unit operating weight for unit LN	kg	6185	6440	6560	6780	6900	9320
Standard unit shipping weight for unit XN	kg	6140	6410	6530	6765	6885	9410
Standard unit operating weight for unit XN	kg	6425	6680	6800	7020	7140	9680
Unit length	mm	8010	8910	8910	9810	9810	11870
Unit width	mm	2230	2230	2230	2230	2230	2230
Unit height	mm	2520	2520	2520	2520	2520	2520

McPower unit size		374.3	395.3	418.3	445.3	464.3 (2)	478.3 (2)
Cooling capacity (1)	kW	1299,3	1365,6	1435,8	1522,5	1586,0	1649,3
Power input (1)	kW	499,0	529,9	558,2	600,3	635,0	669,6
COP		2,60	2,58	2,57	2,54	2,50	2,46
McQuay singlescrew compressors	N°	3	3	3	3	3	3
Refrigerant circuits	N°	3	3	3	3	3	3
Refrigerant charge	kg	250	260	270	280	290	300
Oil charge	l	28	28	28	28	28	28
Min % of capacity reduction	%	8,3	8,3	8,3	8,3	8,3	8,3

Condenser fans

N° of fans / Nominal power fan	kW	25/1,25	26/1,25	28/1,25	28/1,25	29/1,25	30/1,25
Fan speed	rpm	680	680	680	680	680	680
Diameter	mm	800	800	800	800	800	800
Total air flow	m ³ /s	100,9	104,9	115,6	113	113	121

Evaporator

Evaporator / Water volume	N°/l	1 / 432	1 / 432	1 / 432	1 / 419	1 / 419	1 / 419
Max operating pressure	bar	10,5	10,5	10,5	10,5	10,5	10,5
Water connections diameter	mm	273	273	273	273	273	273

Condenser coil

Coil type	Lanced fins – Internally spiral wound tubes						
-----------	---	--	--	--	--	--	--

Weight and dimension

Standard unit shipping weight for unit LN	kg	9505	9625	10060	10075	10410	10470
Standard unit operating weight for unit LN	kg	9980	10100	10530	10520	10860	10920
Standard unit shipping weight for unit XN	kg	9865	9985	10420	10435	10770	10830
Standard unit operating weight for unit XN	kg	10340	10460	10890	10880	11220	11280
Unit length	mm	12770	12770	13670	13670	14570	14570
Unit width	mm	2230	2230	2230	2230	2230	2230
Unit height	mm	2520	2520	2520	2520	2520	2520

Note: (1) Nominal cooling capacity and power input are based on: 12 / 7 °C entering / leaving evaporator water temperature; 35°C ambient temperature. The power input is for compressor only.

(2) Unit XE 464.3 and XE 478.3 are longer than 14000 mm so beware of special transportation required.

Electrical data McPower XE LN and XE XN with HFC 407C

McPower unit size		228.2	255.2	276.2	300.2	320.2	340.3
Standard voltage (1)		400 V – 3f – 50 Hz					
Nominal unit current (2)	A	509	559	661	721	775	758
Max compressor current (3)	A	594	656	712	782	845	886
Fans current	A	37	39	41	44	46	55
Max unit current (3)	A	631	695	753	826	885	941
Max unit inrush current (4)	A	1036	1038	1097	1100	1145	1242
Max unit current for wires sizing (5)	A	657	715	773	832	890	985

McPower unit size		374.3	395.3	418.3	445.3	464.3	478.3
Standard voltage (1)		400 V – 3f – 50 Hz					
Nominal unit current (2)	A	809	852	979	1041	1107	1146
Max compressor current (3)	A	948	1003	1053	1127	1189	1251
Fans current	A	58	60	64	64	67	69
Max unit current (3)	A	1006	1063	1117	1191	1256	1320
Max unit inrush current (4)	A	1228	1318	1362	1366	1461	1450
Max unit current for wires sizing (5)	A	1044	1102	1162	1218	1277	1335

- Notes:** (1) Allowed voltage tolerance $\pm 10\%$. Voltage unbalance between phases must be within $\pm 3\%$.
(2) Nominal current are based on: 12/7 °C entering/leaving evaporator water temperature and 35 °C ambient temp.
(3) Maximum current are based on: 14/9 °C entering/leaving evaporator water temperature and 42 °C ambient temp.
(4) Inrush current of biggest compressor + 75 % of nominal absorbed current of the other compressor + fans current.
(5) Compressor FLA + fans current.

Physical data McPower XE XXN HFC 407C

McPower unit size		228.2	255.2	276.2	300.2	320.2	340.3
Cooling capacity (1)	kW	791,9	880,0	946,8	1030,1	1094,3	1164,6
Power input (1)	kW	329,6	366,7	400,1	442,4	480,6	490,4
COP		2,40	2,40	2,37	2,33	2,28	2,37
McQuay singlescrew compressors	N°	2	2	2	2	2	3
Refrigerant circuits	N°	2	2	2	2	2	3
Refrigerant charge	kg	160	170	180	190	200	240
Oil charge	l	28	28	28	28	28	28
Min % of capacity reduction	%	12,5	12,5	12,5	12,5	12,5	8,3

Condenser fans							
N° of fans / Nominal power fan	kW	16/0,77	17/0,77	18/0,77	19/0,77	20/0,77	24/0,77
Fan speed	rpm	500	500	500	500	500	500
Diameter	mm	800	800	800	800	800	800
Total air flow	m ³ /s	54,8	58,2	61,7	65,1	68,5	82,2

Evaporator							
Evaporator / Water volume	N°/l	1 / 271	1 / 256	1 / 256	1 / 270	1 / 270	1 / 278
Max operating pressure	bar	10,5	10,5	10,5	10,5	10,5	10,5
Water connections diameter	mm	219	219	219	219	219	219

Condenser coil							
Coil type	Lanced fins – Internally spiral wound tubes						

Weight and dimension							
Standard unit shipping weight	kg	6140	6410	6530	6765	6885	9410
Standard unit operating weight	kg	6425	6680	6800	7020	7140	9680
Unit length	mm	8010	8910	8910	9810	9810	11870
Unit width	mm	2230	2230	2230	2230	2230	2230
Unit height	mm	2520	2520	2520	2520	2520	2520

McPower unit size		374.3	395.3	418.3	445.3	464.3 (2)	478.3 (2)
Cooling capacity (1)	kW	1256,7	1320,3	1391,9	1469,3	1529,9	1590,4
Power input (1)	kW	527,7	560,2	587,2	635,1	672,3	709,6
COP		2,38	2,36	2,37	2,31	2,28	2,24
McQuay singlescrew compressors	N°	3	3	3	3	3	3
Refrigerant circuits	N°	3	3	3	3	3	3
Refrigerant charge	kg	250	260	270	280	290	300
Oil charge	l	28	28	28	28	28	28
Min % of capacity reduction	%	8,3	8,3	8,3	8,3	8,3	8,3

Condenser fans							
N° of fans / Nominal power fan	kW	25/0,77	26/0,77	28/0,77	28/0,77	29/0,77	30/0,77
Fan speed	rpm	500	500	500	500	500	500
Diameter	mm	800	800	800	800	800	800
Total air flow	m ³ /s	85,6	89,1	98,5	95,9	95,9	102,8

Evaporator							
Evaporator / Water volume	N°/l	1 / 432	1 / 432	1 / 432	1 / 419	1 / 419	1 / 419
Max operating pressure	bar	10,5	10,5	10,5	10,5	10,5	10,5
Water connections diameter	mm	273	273	273	273	273	273

Condenser coil							
Coil type	Lanced fins – Internally spiral wound tubes						

Weight and dimension							
Standard unit shipping weight	kg	9865	9985	10420	10435	10770	10830
Standard unit operating weight	kg	10340	10460	10890	10880	11220	11280
Unit length	mm	12770	12770	13670	13670	14570	14570
Unit width	mm	2230	2230	2230	2230	2230	2230
Unit height	mm	2520	2520	2520	2520	2520	2520

Note: (1) Nominal cooling capacity and power input are based on: 12 / 7 °C entering / leaving evaporator water temperature; 35°C ambient temperature. The power input is for compressor only.

(2) Unit XE 464.3 and XE 478.3 are longer than 14000 mm so beware of special transportation required.

Electrical data McPower XE XXN HFC 407C

McPower unit size		228.2	255.2	276.2	300.2	320.2	340.3
Standard voltage (1)		400 V – 3f – 50 Hz					
Nominal unit current (2)	A	535	589	677	742	835	787
Max compressor current (3)	A	604	668	725	787	842	900
Fans current	A	24	26	27	29	36	36
Max unit current (3)	A	628	694	752	816	878	936
Max unit inrush current (4)	A	1033	1035	1089	1091	1157	1238
Max unit current for wires sizing (5)	A	644	702	759	817	880	966

McPower unit size		374.3	395.3	418.3	445.3	464.3	478.3
Standard voltage (1)		400 V – 3f – 50 Hz					
Nominal unit current (2)	A	850	897	999	1069	1140	1183
Max compressor current (3)	A	964	1020	1066	1148	1199	1263
Fans current	A	38	39	42	42	42	45
Max unit current (3)	A	1002	1059	1108	1190	1241	1308
Max unit inrush current (4)	A	1234	1323	1350	1356	1455	1445
Max unit current for wires sizing (5)	A	1024	1081	1140	1196	1252	1311

- Notes:** (1) Allowed voltage tolerance $\pm 10\%$. Voltage unbalance between phases must be within $\pm 3\%$.
(2) Nominal current are based on: 12/7 °C entering/leaving evaporator water temperature and 35°C ambient temp.
(3) Maximum current are based on: 14/9 °C entering/leaving evaporator water temperature and 40°C ambient temp.
(4) Inrush current of biggest compressor + 75 % of nominal absorbed current of the other compressor + fans current.
(5) Compressor FLA + fans current.

Sound pressure levels McPower SE, XE ST

McPower Unit Size	Sound pressure level at 1 m from the unit in free field (rif. 2×10^{-5})								
	63 Hz	125 Hz	250 Hz	500 Hz	1000 Hz	2000 Hz	4000 Hz	8000 Hz	dBA
228.2	78,5	79,0	80,5	76,5	76,0	73,0	64,5	56,0	80,5
255.2	78,5	79,0	80,5	76,5	76,0	73,0	64,5	55,5	80,5
276.2	79,0	78,5	81,0	77,0	76,0	74,0	66,0	56,5	81,0
300.2	78,0	78,5	80,5	77,5	76,5	73,0	65,0	57,0	81,0
320.2	78,5	79,0	80,5	78,0	77,0	73,0	64,5	56,0	81,0
340.3	78,5	79,0	80,5	78,0	77,0	73,0	64,5	56,0	81,0
374.3	79,0	79,0	81,0	78,5	77,0	73,5	64,5	56,5	81,5
395.3	79,5	79,5	81,5	79,0	76,5	73,5	65,0	57,0	81,5
418.3	79,5	80,0	81,5	79,5	76,5	73,0	66,0	58,0	81,5
445.3	79,0	81,0	81,5	79,5	76,5	73,5	65,5	57,5	81,5
464.3 only SE	79,0	81,5	82,0	79,5	76,5	73,5	66,0	58,0	81,5
478.3 only SE	79,0	81,5	81,5	79,0	76,5	73,5	66,0	57,5	81,5

Sound pressure levels McPower SE, XE CN

McPower Unit Size	Sound pressure level at 1 m from the unit in free field (rif. 2×10^{-5})								
	63 Hz	125 Hz	250 Hz	500 Hz	1000 Hz	2000 Hz	4000 Hz	8000 Hz	dBA
228.2	76,5	77,0	78,5	74,5	74,0	71,0	62,5	54,0	78,5
255.2	76,5	77,0	78,5	74,5	74,0	71,0	62,5	53,5	78,5
276.2	77,0	76,5	79,0	75,0	74,0	72,0	64,0	54,5	79,0
300.2	76,0	76,5	78,5	75,5	74,5	71,0	63,0	55,0	79,0
320.2	76,5	77,0	78,5	76,0	75,0	71,0	62,5	54,0	79,0
340.3	76,5	77,0	78,5	76,0	75,0	71,0	62,5	54,0	79,0
374.3	77,0	77,0	79,0	76,5	75,0	71,5	62,5	54,5	79,5
395.3	77,5	77,5	79,5	77,0	74,5	71,5	63,0	55,0	79,5
418.3	77,5	78,0	79,5	77,5	74,5	71,0	64,0	56,0	79,5
445.3	77,0	79,0	79,5	77,5	74,5	71,5	63,5	55,5	79,5
464.3 only SE	77,0	79,5	80,0	77,5	74,5	71,5	64,0	56,0	79,5
478.3 only SE	77,0	79,5	79,5	77,0	74,5	71,5	64,0	55,5	79,5

Sound pressure levels McPower SE, XE LN

McPower Unit Size	Sound pressure level at 1 m from the unit in free field (rif. 2×10^{-5})								
	63 Hz	125 Hz	250 Hz	500 Hz	1000 Hz	2000 Hz	4000 Hz	8000 Hz	dBA
228.2	74,5	71,5	74,5	71,5	70,0	67,5	58,5	51,5	75,0
255.2	75,0	72,0	74,5	71,5	70,5	67,5	59,0	51,5	75,0
276.2	75,5	72,5	75,0	72,0	71,0	67,5	59,5	52,0	75,5
300.2	75,5	73,0	75,5	72,5	71,0	69,0	59,5	52,5	76,0
320.2	76,0	73,0	76,0	72,5	71,0	69,0	60,0	53,0	76,0
340.3	77,0	73,5	76,5	73,0	71,5	69,0	60,5	53,5	76,5
374.3	77,5	73,0	76,0	73,0	71,5	69,0	60,5	53,0	76,0
395.3	77,5	73,5	75,5	73,5	71,0	69,0	60,5	53,0	76,0
418.3	78,0	74,0	75,5	73,5	71,5	69,5	60,5	54,0	76,5
445.3	78,0	74,5	76,0	73,5	72,0	69,5	60,0	53,5	76,5
464.3 only SE	78,5	75,0	76,0	73,5	72,5	69,5	60,5	54,0	77,0
478.3 only SE	78,5	75,5	76,5	74,0	72,5	69,5	60,5	54,5	77,0

Note: Average sound pressure level rated in accordance to ISO 3744, free field semispheric conditions.

Note: Sound pressure levels are referred to McPower Units furnished without water pump and/or high lift fans.

Sound pressure levels McPower SE, XE XN

McPower Unit Size	Sound pressure level at 1 m from the unit in free field (rif. 2×10^{-5})								
	63 Hz	125 Hz	250 Hz	500 Hz	1000 Hz	2000 Hz	4000 Hz	8000 Hz	dBA
228.2	76,0	73,5	73,0	70,5	67,5	62,5	55,5	47,5	72,5
255.2	76,0	73,5	73,0	70,5	67,5	62,5	55,5	47,5	72,5
276.2	76,0	74,0	73,0	70,5	67,5	63,0	55,5	47,5	72,5
300.2	76,0	74,0	73,5	70,5	67,5	63,0	55,5	47,5	72,5
320.2	76,0	74,0	73,5	71,0	67,5	63,0	56,0	48,0	72,5
340.3	76,5	74,5	74,0	71,0	68,0	63,5	55,5	47,5	73,0
374.3	76,0	74,0	73,0	70,5	67,5	63,0	55,5	47,5	72,5
395.3	77,0	75,0	74,0	71,0	68,0	63,5	56,0	48,0	73,0
418.3	77,5	75,5	74,0	71,0	68,0	63,5	56,0	48,5	73,0
445.3	78,0	76,0	73,5	71,0	68,5	63,5	57,0	49,0	73,0
464.3 only SE	77,5	75,5	74,5	71,5	68,0	63,5	57,5	49,0	73,5
478.3 only SE	78,0	75,0	74,5	72,0	68,0	64,0	57,0	49,5	73,5

Sound pressure levels McPower SE, XE XXN

McPower Unit Size	Sound pressure level at 1 m from the unit in free field (rif. 2×10^{-5})								
	63 Hz	125 Hz	250 Hz	500 Hz	1000 Hz	2000 Hz	4000 Hz	8000 Hz	dBA
228.2	63,5	65,5	67,5	66,5	59,0	55,0	51,5	44,5	66,5
255.2	63,5	65,0	68,0	66,5	59,5	55,0	52,0	45,0	66,5
276.2	63,0	65,5	67,5	67,0	59,0	54,5	52,0	45,5	66,5
300.2	63,5	66,0	68,0	67,0	59,0	54,5	52,0	46,0	67,0
320.2	64,0	67,0	68,0	67,0	59,5	55,0	52,5	46,0	67,0
340.3	65,0	67,5	68,5	67,0	60,0	55,0	53,0	46,5	67,0
374.3	63,0	65,5	67,5	67,0	59,0	54,5	52,0	45,5	66,5
395.3	64,0	66,5	68,0	67,5	59,5	55,5	52,5	46,0	67,0
418.3	64,5	67,0	68,5	67,5	59,5	56,0	53,0	46,5	67,5
445.3	65,0	67,0	68,5	68,0	59,0	56,0	53,5	46,5	67,5
464.3 only SE	65,5	67,5	68,5	68,0	59,5	56,0	53,0	47,0	67,5
478.3 only SE	64,5	67,0	69,0	67,5	60,0	56,5	53,5	47,0	67,5

Note: Average sound pressure level rated in accordance to ISO 3744, free field semispheric conditions.

Note: Sound pressure levels are referred to McPower Units furnished without water pump and/or high lift fans.

Standard ratings McPower SE 228.2 ÷ 395.3 ST, CN

Unit size	Evap. leaving water temp. °C	AIR AMBIENT TEMPERATURE - °C									
		25		30		35		40		42	
		Cooling capacity kW	Power input kW	Cooling capacity kW	Power input kW	Cooling capacity kW	Power input kW	Cooling capacity kW	Power input kW	Cooling capacity kW	Power input kW
228.2	4	808,7	248,3	768,6	275,7	726,4	307,3	681,4	343,5	662,8	359,5
	5	831,4	251,7	790,6	279,0	747,5	310,4	701,6	346,4	682,6	362,2
	6	854,5	255,2	812,9	282,4	768,8	313,6	722,1	349,3	702,7	365,0
	7	877,8	258,8	835,3	286,0	790,4	317,0	742,8	352,5	723,0	368,0
	8	901,5	262,5	858,0	289,6	812,3	320,5	763,7	355,7	743,6	371,2
	9	925,4	266,2	881,0	293,4	834,3	324,2	784,9	359,2	764,3	374,5
255.2	4	895,8	274,7	851,1	303,6	804,2	336,5	754,4	373,9	733,8	390,3
	5	920,9	278,6	875,5	307,5	827,5	340,2	776,8	377,5	755,6	393,7
	6	946,6	282,7	900,1	311,5	851,1	344,2	799,3	381,2	777,8	397,3
	7	972,3	286,9	924,9	315,7	875,0	348,2	822,1	385,1	800,2	401,1
	8	998,5	291,2	950,1	320,0	899,1	352,5	845,2	389,1	822,8	405,1
	9	1024,9	295,6	975,5	324,4	923,5	356,8	868,5	393,3	845,6	409,2
276.2	4	965,7	298,5	918,1	329,1	868,0	363,6	814,9	402,5	792,9	419,4
	5	992,6	302,9	944,1	333,5	892,9	367,9	838,8	406,7	816,3	423,5
	6	1019,9	307,4	970,4	338,0	918,0	372,4	862,9	411,0	840,0	427,7
	7	1047,4	311,9	996,8	342,6	943,6	376,9	887,3	415,5	863,9	432,1
	8	1075,2	316,7	1023,7	347,3	969,3	381,7	911,9	420,1	888,0	436,7
	9	1103,4	321,5	1050,7	352,2	995,3	386,5	936,8	424,9	912,4	441,4
300.2	4	1051,1	326,7	998,9	360,0	943,9	397,6	885,7	440,0	861,4	458,4
	5	1080,5	331,5	1027,2	364,9	970,9	402,4	911,6	444,6	886,8	463,0
	6	1110,1	336,5	1055,8	369,8	998,4	407,3	937,7	449,4	912,6	467,7
	7	1140,2	341,5	1084,6	374,9	1026,1	412,4	964,2	454,4	938,5	472,6
	8	1170,6	346,8	1113,8	380,2	1054,1	417,6	991,0	459,5	964,8	477,6
	9	1201,2	352,1	1143,3	385,6	1082,4	423,0	1018,1	464,8	991,3	482,9
320.2	4	1118,6	351,9	1063,4	388,2	1005,0	429,1	943,3	475,2	917,5	495,3
	5	1149,6	357,0	1093,1	393,3	1033,7	434,2	970,8	480,1	944,4	500,1
	6	1180,8	362,3	1123,3	398,6	1062,7	439,4	998,4	485,2	971,6	505,1
	7	1212,5	367,7	1153,9	404,0	1091,9	444,8	1026,4	490,5	999,1	510,3
	8	1244,5	373,2	1184,6	409,6	1121,5	450,3	1054,6	495,9	1026,9	515,7
	9	1277,0	378,9	1215,8	415,4	1151,3	456,1	1083,3	501,6	1054,9	521,2
340.3	4	1183,6	368,2	1126,1	409,7	1065,2	457,4	1000,6	512,4	973,6	536,7
	5	1216,5	373,0	1157,8	414,3	1095,8	461,8	1030,0	516,4	1002,3	540,4
	6	1249,8	378,0	1190,1	419,2	1126,8	466,4	1059,6	520,5	1031,4	544,4
	7	1283,5	383,0	1222,5	424,1	1158,0	471,2	1089,6	524,9	1060,9	548,6
	8	1317,5	388,3	1255,4	429,3	1189,7	476,1	1119,9	529,6	1090,7	553,0
	9	1352,0	393,6	1288,6	434,6	1221,6	481,3	1150,5	534,4	1120,7	557,6
374.3	4	1315,2	401,1	1249,2	443,5	1179,8	492,0	1106,1	547,2	1075,4	571,5
	5	1352,5	406,9	1285,1	449,2	1214,1	497,4	1139,1	552,4	1107,8	576,4
	6	1390,3	412,8	1321,4	455,1	1249,0	503,1	1172,4	557,7	1140,5	581,6
	7	1428,4	419,0	1358,2	461,2	1284,2	509,1	1206,1	563,3	1173,6	587,0
	8	1467,0	425,3	1395,4	467,5	1319,9	515,2	1240,2	569,2	1207,1	592,7
	9	1506,2	431,7	1433,0	473,9	1356,0	521,5	1274,6	575,3	1240,7	598,7
395.3	4	1385,9	425,1	1316,9	469,2	1244,0	519,3	1167,3	576,0	1135,2	600,8
	5	1424,9	431,3	1354,3	475,4	1280,2	525,3	1201,7	581,7	1168,9	606,3
	6	1464,4	437,7	1392,5	481,7	1316,6	531,5	1236,6	587,7	1203,2	612,2
	7	1504,3	444,2	1430,8	488,3	1353,5	537,9	1271,7	593,9	1237,8	618,2
	8	1544,7	450,9	1469,7	495,0	1390,7	544,6	1307,4	600,3	1272,8	624,5
	9	1585,6	457,8	1509,1	501,9	1428,5	551,4	1343,5	607,0	1308,1	631,1

Note: The power input is for compressor only; cooling cap. and power input referred to evap. fouling factor=0,0176m² °C/kW.

Standard ratings McPower SE 418.3 ÷ 478.3 ST, CN

Unit size	Evap. leaving water temp. °C	AIR AMBIENT TEMPERATURE - °C									
		25		30		35		40		42	
		Cooling capacity kW	Power input kW	Cooling capacity kW	Power input kW	Cooling capacity kW	Power input kW	Cooling capacity kW	Power input kW	Cooling capacity kW	Power input kW
418.3	4	1459,4	447,3	1387,4	492,9	1311,6	544,4	1231,5	602,4	1198,1	627,6
	5	1500,3	453,9	1426,9	499,5	1349,4	550,9	1267,6	608,6	1233,6	633,7
	6	1541,6	460,6	1466,6	506,3	1387,6	557,6	1304,2	615,1	1269,5	640,1
	7	1583,4	467,5	1506,9	513,2	1426,3	564,5	1341,2	621,9	1305,7	646,7
	8	1625,8	474,6	1547,6	520,4	1465,4	571,6	1378,6	628,9	1342,5	653,6
	9	1668,5	481,9	1588,8	527,8	1504,8	578,9	1416,4	636,1	1379,5	660,7
445.3	4	1553,8	479,1	1476,0	527,6	1394,0	582,2	1307,5	643,8	1271,4	670,5
	5	1597,4	486,3	1517,9	534,8	1434,3	589,3	1346,0	650,7	1309,2	677,3
	6	1641,6	493,7	1560,5	542,2	1475,1	596,7	1384,9	657,8	1347,4	684,3
	7	1686,3	501,3	1603,5	549,9	1516,3	604,3	1424,3	665,2	1386,1	691,6
	8	1731,4	509,1	1646,9	557,7	1557,9	612,1	1464,0	672,9	1425,1	699,1
	9	1777,2	517,1	1690,7	565,8	1600,0	620,1	1504,2	680,8	1464,5	706,9
464.3	4	1622,1	504,5	1541,2	555,9	1456,0	613,9	1365,9	679,2	1328,3	707,5
	5	1667,5	512,1	1584,9	563,4	1497,8	621,3	1405,8	686,3	1367,5	714,6
	6	1713,4	519,8	1629,0	571,2	1540,3	628,9	1446,3	693,8	1407,2	721,9
	7	1759,8	527,7	1673,5	579,1	1583,0	636,8	1487,2	701,5	1447,4	729,5
	8	1806,7	535,8	1718,8	587,3	1626,3	645,0	1528,5	709,5	1487,9	737,3
	9	1854,0	544,1	1764,3	595,7	1669,9	653,3	1570,2	717,7	1528,9	745,5
478.3	4	1690,5	530,0	1606,6	584,3	1517,9	645,5	1424,2	714,5	1385,1	744,5
	5	1737,6	537,8	1651,8	592,1	1561,4	653,2	1465,8	722,0	1425,9	751,8
	6	1785,1	545,8	1697,5	600,1	1605,3	661,2	1507,7	729,7	1467,0	759,5
	7	1833,3	554,0	1743,8	608,4	1649,8	669,4	1550,2	737,8	1508,7	767,4
	8	1881,8	562,5	1790,6	616,9	1694,6	677,9	1593,1	746,1	1550,8	775,6
	9	1930,8	571,1	1837,8	625,7	1739,9	686,6	1636,4	754,6	1593,3	784,0

Note: The power input is for compressor only; cooling cap. and power input referred to evap. fouling factor=0,0176m² °C/kW.

Standard ratings McPower SE 228.2 ÷ 395.3 LN, XN

Unit size	Evap. leaving water temp. °C	AIR AMBIENT TEMPERATURE - °C							
		25		30		35		38	
		Cooling capacity kW	Power input kW	Cooling capacity kW	Power input kW	Cooling capacity kW	Power input kW	Cooling capacity kW	Power input kW
228.2	4	771,2	273,9	729,4	304,9	685,2	340,5	657,2	364,4
	5	792,3	277,9	749,7	308,7	704,4	344,1	675,9	367,8
	6	813,6	281,9	770,1	312,7	724,0	347,9	694,8	371,4
	7	835,0	286,1	790,7	316,8	743,7	351,8	714,0	375,2
	8	856,8	290,5	811,4	321,0	763,5	355,9	733,3	379,1
255.2	4	853,1	302,3	806,8	334,6	757,7	371,3	726,9	395,8
	5	876,4	306,9	829,0	339,1	779,0	375,7	747,6	400,1
	6	899,9	311,6	851,5	343,8	800,5	380,3	768,3	404,5
	7	923,6	316,5	874,3	348,7	822,1	385,1	789,4	409,1
	8	947,5	321,6	897,2	353,7	844,0	390,0	810,6	413,9
276.2	4	920,1	327,8	870,7	361,7	818,3	399,9	785,5	425,2
	5	944,9	332,9	894,5	366,8	841,0	405,0	807,6	430,1
	6	970,1	338,2	918,5	372,1	864,1	410,2	829,8	435,2
	7	995,3	343,6	942,7	377,5	887,1	415,6	852,2	440,5
	8	1020,7	349,1	967,2	383,1	910,5	421,1	874,8	446,0
300.2	4	1000,2	359,2	945,8	396,2	888,5	437,9	852,4	465,4
	5	1027,2	364,8	971,7	401,9	913,2	443,5	876,3	470,9
	6	1054,4	370,7	997,8	407,7	938,0	449,3	900,5	476,6
	7	1081,9	376,6	1024,1	413,7	963,2	455,2	924,7	482,5
	8	1109,6	382,8	1050,7	419,9	988,4	461,3	949,2	488,5
320.2	4	1064,5	387,3	1007,1	427,6	946,2	473,1	907,7	503,1
	5	1093,1	393,3	1034,3	433,7	972,1	479,0	933,1	508,9
	6	1121,9	399,5	1061,9	439,9	998,5	485,2	958,5	515,0
	7	1150,9	405,9	1089,7	446,3	1025,0	491,5	984,2	521,2
	8	1180,3	412,4	1117,8	452,8	1051,6	498,0	1010,2	527,7
340.3	4	1130,8	406,1	1070,8	452,9	1006,9	506,9	966,4	543,2
	5	1161,3	411,8	1100,1	458,4	1034,9	512,0	993,7	548,0
	6	1192,2	417,5	1129,8	464,1	1063,4	517,4	1021,2	553,1
	7	1223,4	423,5	1159,7	469,9	1091,9	523,0	1049,2	558,5
	8	1254,8	429,7	1189,9	476,0	1120,7	528,8	1077,2	564,1
374.3	4	1251,9	441,8	1183,4	489,3	1110,8	543,6	1065,1	579,8
	5	1286,3	448,5	1216,3	495,9	1142,2	550,0	1095,6	586,0
	6	1320,9	455,4	1249,5	502,8	1173,9	556,6	1126,4	592,4
	7	1356,0	462,6	1283,1	509,9	1205,8	563,5	1157,3	599,1
	8	1391,3	470,0	1316,9	517,2	1238,1	570,6	1188,6	606,0
395.3	4	1319,5	467,5	1247,7	516,6	1171,9	572,4	1124,2	609,3
	5	1355,5	474,7	1282,2	523,8	1204,8	579,4	1156,2	616,2
	6	1391,7	482,2	1317,1	531,2	1238,0	586,7	1188,3	623,3
	7	1428,3	489,8	1352,1	538,9	1271,3	594,2	1220,7	630,6
	8	1465,3	497,7	1387,4	546,8	1305,1	601,9	1253,5	638,2
395.3	9	1502,6	505,8	1423,0	554,9	1339,1	609,9	1286,5	646,1

Note: The power input is for compressor only; cooling cap. and power input referred to evap. fouling factor=0,0176m² °C/kW.

Standard ratings McPower SE 418.3 ÷ 478.3 LN, XN

Unit size	Evap. leaving water temp. °C	AIR AMBIENT TEMPERATURE - °C							
		25		30		35		38	
		Cooling capacity kW	Power input kW	Cooling capacity kW	Power input kW	Cooling capacity kW	Power input kW	Cooling capacity kW	Power input kW
418.3	4	1394,4	488,4	1320,0	538,6	1241,2	595,2	1191,7	632,5
	5	1432,3	496,0	1356,3	546,2	1275,9	602,7	1225,3	639,9
	6	1470,5	503,8	1392,9	554,1	1310,8	610,5	1259,3	647,6
	7	1509,2	511,9	1429,9	562,1	1346,1	618,5	1293,6	655,5
	8	1548,1	520,1	1467,1	570,5	1381,7	626,7	1328,1	663,6
	9	1587,4	528,6	1504,7	579,0	1417,6	635,2	1363,0	672,1
445.3	4	1477,4	526,7	1396,8	580,4	1311,4	640,9	1257,8	680,8
	5	1517,5	535,1	1435,1	588,8	1348,0	649,2	1293,4	689,0
	6	1558,0	543,7	1473,7	597,5	1384,9	657,8	1329,1	697,5
	7	1598,9	552,6	1513,0	606,4	1422,1	666,7	1365,2	706,2
	8	1640,2	561,8	1552,3	615,6	1459,7	675,8	1401,6	715,2
	9	1681,7	571,1	1592,1	625,0	1497,5	685,2	1438,3	724,5
464.3	4	1542,7	555,0	1458,6	612,0	1369,8	676,3	1313,9	718,7
	5	1584,3	563,8	1498,5	620,8	1407,7	685,0	1350,6	727,2
	6	1626,5	572,8	1538,7	629,9	1446,1	693,9	1387,9	736,0
	7	1668,9	582,1	1579,4	639,2	1484,7	703,2	1425,4	745,2
	8	1711,7	591,6	1620,2	648,8	1523,8	712,7	1463,2	754,6
	9	1754,8	601,4	1661,5	658,6	1563,1	722,5	1501,3	764,3
478.3	4	1607,9	583,3	1520,5	643,6	1428,0	711,6	1369,8	756,5
	5	1651,2	592,5	1561,9	652,8	1467,4	720,7	1408,1	765,4
	6	1694,8	601,9	1603,6	662,3	1507,3	730,0	1446,7	774,6
	7	1738,8	611,6	1645,8	672,0	1547,4	739,7	1485,7	784,1
	8	1783,2	621,5	1688,2	682,0	1587,8	749,6	1524,8	794,0
	9	1827,9	631,7	1731,0	692,3	1628,6	759,8	1564,4	804,1

Note: The power input is for compressor only; cooling cap. and power input referred to evap. fouling factor=0,0176m² °C/kW.

Standard ratings McPower SE 228.2 ÷ 340.3 XXN

Unit size	Evap. leaving water temp. °C	AIR AMBIENT TEMPERATURE - °C									
		25		30		35		38		40	
		Cooling capacity kW	Power input kW	Cooling capacity kW	Power input kW	Cooling capacity kW	Power input kW	Cooling capacity kW	Power input kW	Cooling capacity kW	Power input kW
228.2	4	743,4	294,3	700,2	328,1	654,2	367,1	497,2	323,0	392,5	286,3
	5	763,1	298,7	719,0	332,4	672,1	371,1	510,8	326,6	403,2	289,5
	6	783,1	303,2	738,1	336,8	690,3	375,3	524,7	330,3	414,2	292,7
	7	803,2	307,9	757,4	341,4	708,5	379,6	538,5	334,0	425,1	296,1
	8	823,6	312,7	776,7	346,1	727,0	384,1	552,5	338,0	436,2	299,6
	9	844,0	317,6	796,2	350,9	745,4	388,8	566,5	342,1	447,2	303,3
255.2	4	821,5	324,0	773,7	359,1	723,0	398,9	549,4	351,0	433,7	311,1
	5	843,4	329,2	794,5	364,1	742,7	403,8	564,4	355,3	445,7	315,0
	6	865,3	334,4	815,6	369,3	762,6	408,9	579,6	359,8	457,5	318,9
	7	887,6	339,9	836,7	374,7	782,7	414,1	594,8	364,4	469,6	323,0
	8	909,8	345,4	857,9	380,3	802,9	419,5	610,2	369,2	481,7	327,2
	9	932,3	351,2	879,3	386,0	823,2	425,1	625,6	374,1	493,9	331,6
276.2	4	886,3	350,8	835,3	387,3	781,3	428,4	593,8	377,0	468,8	334,2
	5	909,6	356,5	857,6	393,0	802,4	434,0	609,8	381,9	481,4	338,5
	6	933,1	362,3	879,9	398,8	823,7	439,8	626,0	387,0	494,2	343,0
	7	956,8	368,3	902,5	404,8	845,0	445,7	642,2	392,2	507,0	347,6
	8	980,6	374,4	925,1	411,0	866,6	451,9	658,7	397,7	519,9	352,5
	9	1004,5	380,7	948,0	417,3	888,3	458,2	675,1	403,2	532,9	357,4
300.2	4	962,4	384,7	906,5	424,5	847,2	469,5	643,9	413,2	508,3	366,2
	5	987,7	391,0	930,6	430,8	870,0	475,7	661,3	418,6	522,0	371,0
	6	1013,2	397,4	954,8	437,3	893,0	482,1	678,7	424,2	535,8	376,0
	7	1038,8	404,1	979,2	444,0	916,2	488,7	696,3	430,1	549,7	381,2
	8	1064,6	410,9	1003,8	450,8	939,5	495,5	714,0	436,0	563,7	386,5
	9	1090,7	417,9	1028,6	457,9	962,9	502,4	731,8	442,1	577,7	391,9
320.2	4	1024,4	415,1	965,1	458,6	902,0	507,6	685,5	446,7	541,2	395,9
	5	1051,2	421,8	990,6	465,3	926,2	514,3	703,9	452,6	555,7	401,2
	6	1078,1	428,7	1016,2	472,3	950,6	521,1	722,4	458,6	570,3	406,5
	7	1105,2	435,8	1042,1	479,4	975,0	528,1	741,0	464,7	585,0	411,9
	8	1132,5	443,1	1067,9	486,7	999,6	535,4	759,7	471,2	599,8	417,6
	9	1160,0	450,5	1094,1	494,2	1024,3	542,8	778,5	477,7	614,6	423,4
340.3	4	1091,4	436,4	1029,2	487,6	962,6	546,6	731,6	481,0	577,6	426,3
	5	1120,3	442,7	1056,8	493,6	988,9	552,3	751,6	486,0	593,4	430,8
	6	1149,4	449,1	1084,5	499,9	1015,4	558,3	771,7	491,3	609,2	435,5
	7	1178,6	455,8	1112,6	506,4	1042,1	564,5	792,0	496,8	625,2	440,3
	8	1208,1	462,6	1140,7	513,2	1068,9	570,9	812,4	502,4	641,4	445,3
	9	1237,9	469,6	1169,2	520,1	1095,9	577,6	832,9	508,3	657,6	450,5

Note: The power input is for compressor only; cooling cap. and power input referred to evap. fouling factor=0,0176m² °C/kW.

Note: Shaded area reflects Microtech II C Plus control algorithms

Standard ratings McPower SE 374.3 ÷ 478.3 XXN

Unit size	Evap. leaving water temp. °C	AIR AMBIENT TEMPERATURE - °C									
		25		30		35		38		40	
		Cooling capacity kW	Power input kW	Cooling capacity kW	Power input kW	Cooling capacity kW	Power input kW	Cooling capacity kW	Power input kW	Power input kW	Power input kW
374.3	4	1205,0	473,9	1134,3	525,5	1059,3	584,6	805,0	514,4	635,5	456,0
	5	1237,2	481,4	1165,0	532,9	1088,4	591,6	827,2	520,6	653,0	461,4
	6	1269,7	489,1	1196,0	540,5	1117,8	599,0	849,5	527,1	670,6	467,2
	7	1302,4	497,0	1227,2	548,3	1147,3	606,5	872,0	533,7	688,3	473,1
	8	1335,3	505,2	1258,6	556,4	1177,2	614,4	894,7	540,7	706,3	479,2
	9	1368,5	513,5	1290,2	564,8	1207,2	622,5	917,4	547,8	724,3	485,6
395.3	4	1270,4	500,8	1196,6	553,9	1118,1	614,2	849,8	540,5	670,8	479,1
	5	1304,0	508,8	1228,6	561,9	1148,6	622,0	872,9	547,4	689,2	485,2
	6	1338,0	517,1	1260,9	570,2	1179,4	630,0	896,3	554,4	707,6	491,4
	7	1372,2	525,6	1293,6	578,6	1210,3	638,3	919,8	561,7	726,2	497,9
	8	1406,7	534,3	1326,4	587,4	1241,4	646,9	943,5	569,3	744,8	504,6
	9	1441,3	543,3	1359,4	596,3	1272,7	655,7	967,3	577,0	763,6	511,4
418.3	4	1347,9	519,5	1271,2	573,2	1190,3	633,7	904,6	557,7	714,2	494,3
	5	1383,6	527,9	1305,4	581,6	1222,6	642,0	929,2	565,0	733,6	500,8
	6	1419,6	536,5	1339,8	590,3	1255,3	650,6	954,0	572,5	753,1	507,5
	7	1455,9	545,4	1374,4	599,2	1288,2	659,4	979,0	580,3	772,9	514,3
	8	1492,5	554,5	1409,3	608,3	1321,4	668,4	1004,3	588,2	792,8	521,4
	9	1529,3	563,8	1444,4	617,7	1354,7	677,7	1029,6	596,4	812,8	528,6
445.3	4	1421,0	563,8	1337,9	621,7	1249,9	686,9	950,0	604,5	749,9	535,8
	5	1458,5	573,2	1373,7	631,1	1283,8	696,1	975,7	612,6	770,2	543,0
	6	1496,4	582,8	1409,7	640,7	1317,9	705,6	1001,6	620,9	790,7	550,4
	7	1534,4	592,7	1445,9	650,6	1352,3	715,4	1027,7	629,6	811,3	558,0
	8	1572,7	602,8	1482,4	660,8	1386,8	725,5	1054,0	638,4	832,0	565,9
	9	1611,2	613,2	1519,0	671,2	1421,5	735,8	1080,4	647,5	852,9	573,9
464.3	4	1483,8	594,5	1397,2	656,0	1305,3	725,2	992,0	638,2	783,2	565,7
	5	1522,9	604,3	1434,3	665,8	1340,5	734,9	1018,8	646,7	804,3	573,2
	6	1562,1	614,3	1471,8	675,8	1376,1	744,8	1045,9	655,4	825,6	580,9
	7	1601,7	624,7	1509,4	686,2	1411,7	755,1	1073,0	664,5	847,1	589,0
	8	1641,4	635,3	1547,2	696,8	1447,6	765,6	1100,1	673,7	868,5	597,2
	9	1681,5	646,1	1585,4	707,8	1483,7	776,5	1127,6	683,3	890,2	605,7
478.3	4	1546,8	625,2	1456,5	690,2	1360,7	763,6	1034,1	672,0	816,5	595,6
	5	1587,1	635,4	1495,0	700,5	1397,3	773,6	1061,9	680,8	838,4	603,4
	6	1627,8	645,9	1533,8	711,0	1434,1	784,0	1089,8	689,9	860,5	611,5
	7	1668,9	656,7	1572,9	721,8	1471,1	794,7	1118,1	699,3	882,7	619,9
	8	1710,1	667,7	1612,2	732,9	1508,4	805,7	1146,4	709,0	905,1	628,4
	9	1751,7	679,0	1651,7	744,3	1545,9	817,1	1174,9	719,0	927,5	637,3

Note: The power input is for compressor only; cooling cap. and power input referred to evap. fouling factor=0,0176m² °C/kW.

Note: Shaded area reflects Microtech II C Plus control algorithms

Standard ratings McPower XE 228.2 ÷ 374.3 ST, CN

Unit size	Evap. leaving water temp. °C	AIR AMBIENT TEMPERATURE - °C											
		25		30		35		40		45		46	
		Cooling capac. kW	Power input kW	Cooling capac. kW	Power input kW	Cooling capac. kW	Power input kW	Cooling capac. kW	Power input kW	Cooling capac. kW	Power input kW	Cooling capac. kW	Power input kW
228.2	4	864,4	227,6	824,3	251,8	782,0	279,6	737,6	311,4	690,5	348,0	680,7	356,0
	5	889,8	230,6	848,7	254,7	805,7	282,3	760,3	313,9	712,2	350,2	702,3	358,0
	6	915,6	233,7	873,6	257,8	829,7	285,2	783,3	316,5	734,4	352,5	724,2	360,2
	7	941,6	236,8	898,9	260,9	854,1	288,2	806,7	319,3	756,7	354,9	746,3	362,6
	8	968,1	240,1	924,4	264,1	878,6	291,3	830,4	322,3	779,4	357,5	768,9	365,2
255.2	4	967,5	255,2	921,4	281,0	873,3	310,3	822,8	343,6	769,3	381,4	758,3	389,6
	5	996,0	258,8	949,0	284,6	899,9	313,8	848,2	346,8	793,7	384,4	782,5	392,5
	6	1025,1	262,5	977,2	288,3	926,9	317,4	874,1	350,3	818,4	387,5	807,0	395,6
	7	1054,5	266,3	1005,5	292,1	954,2	321,1	900,3	353,8	843,5	390,9	831,7	398,8
	8	1084,4	270,3	1034,2	296,0	981,9	325,0	926,9	357,6	868,9	394,3	857,0	402,2
276.2	4	1042,8	279,5	993,4	307,2	941,7	338,4	887,6	373,5	830,3	413,0	818,4	421,5
	5	1073,3	283,5	1022,9	311,2	970,2	342,3	914,6	377,3	856,2	416,7	844,2	425,1
	6	1104,1	287,7	1052,7	315,4	998,8	346,4	942,1	381,3	882,5	420,4	870,2	428,8
	7	1135,5	291,9	1082,9	319,7	1027,8	350,7	970,2	385,4	909,2	424,4	896,6	432,7
	8	1167,3	296,3	1113,6	324,1	1057,4	355,0	998,4	389,7	936,3	428,5	923,4	436,8
300.2	4	1141,8	308,1	1086,9	338,3	1029,3	372,4	968,8	410,7	905,2	453,8	892,0	463,1
	5	1175,3	312,7	1119,1	342,9	1060,4	376,9	998,6	415,0	933,6	457,9	920,2	467,1
	6	1209,3	317,4	1152,0	347,6	1091,9	381,5	1028,8	419,5	962,4	462,2	948,7	471,4
	7	1243,9	322,2	1185,2	352,5	1123,9	386,3	1059,5	424,2	991,6	466,7	977,6	475,8
	8	1278,8	327,1	1218,9	357,5	1156,3	391,3	1090,5	429,1	1021,2	471,4	1007,0	480,4
320.2	4	1215,4	333,4	1157,1	366,3	1095,9	403,4	1031,6	445,2	963,9	492,3	949,8	502,4
	5	1250,8	338,3	1191,2	371,2	1128,8	408,3	1063,1	449,9	993,8	496,7	979,5	506,8
	6	1286,8	343,3	1225,8	376,3	1162,0	413,3	1094,9	454,7	1024,2	501,3	1009,7	511,3
	7	1323,1	348,5	1260,8	381,5	1195,7	418,4	1127,3	459,8	1055,1	506,2	1040,2	516,1
	8	1360,0	353,8	1296,5	386,8	1229,9	423,7	1160,0	465,0	1086,3	511,2	1071,1	521,0
340.3	4	1267,2	338,1	1209,3	374,6	1148,5	416,5	1084,2	464,8	1016,1	520,2	1001,9	532,3
	5	1303,9	342,3	1244,8	378,7	1182,7	420,4	1117,2	468,3	1047,7	523,2	1033,4	535,1
	6	1341,1	346,7	1280,8	383,0	1217,5	424,5	1150,6	472,0	1079,9	526,4	1065,1	538,2
	7	1378,8	351,2	1317,3	387,5	1252,7	428,8	1184,5	475,9	1112,3	529,9	1097,4	541,5
	8	1417,1	355,8	1354,2	392,0	1288,3	433,2	1218,9	480,1	1145,3	533,5	1130,0	545,1
374.3	4	1374,4	365,9	1310,6	404,0	1243,5	447,4	1172,9	496,9	1098,1	553,4	1082,6	565,7
	5	1414,6	370,8	1349,4	408,8	1280,8	452,0	1208,7	501,2	1132,5	557,3	1116,7	569,4
	6	1455,3	375,8	1388,6	413,8	1318,7	456,8	1245,2	505,8	1167,3	561,4	1151,2	573,4
	7	1496,5	381,0	1428,5	418,9	1357,1	461,9	1282,0	510,5	1202,7	565,7	1186,4	577,6
	8	1538,3	386,3	1468,9	424,3	1396,1	467,1	1319,4	515,5	1238,5	570,3	1221,8	582,1
395.3	4	1445,7	389,5	1378,8	429,5	1308,5	474,8	1234,5	526,1	1156,2	584,4	1140,0	596,9
	5	1487,4	394,8	1419,2	434,7	1347,4	479,9	1271,8	531,0	1192,0	588,8	1175,5	601,3
	6	1530,0	400,2	1460,2	440,1	1387,0	485,2	1309,9	536,0	1228,4	593,5	1211,5	605,9
	7	1572,9	405,8	1501,6	445,7	1427,1	490,7	1348,3	541,3	1265,3	598,5	1248,1	610,7
	8	1616,4	411,5	1543,8	451,5	1467,5	496,3	1387,2	546,8	1302,5	603,6	1285,0	615,8
	9	1660,5	417,4	1586,4	457,4	1508,6	502,2	1426,8	552,5	1340,4	609,0	1322,5	621,1

Note: The power input is for compressor only; cooling cap. and power input referred to evap. fouling factor=0,0176m² °C/kW.

Standard ratings McPower XE 418.3 ÷ 478.3 ST, CN

Unit size	Evap. leaving water temp. °C	AIR AMBIENT TEMPERATURE - °C											
		25		30		35		40		45		46	
		Cooling capac. kW	Power input kW	Cooling capac. kW	Power input kW	Cooling capac. kW	Power input kW	Cooling capac. kW	Power input kW	Cooling capac. kW	Power input kW	Cooling capac. kW	Power input kW
418.3	4	1517,1	413,0	1447,2	454,8	1373,8	502,0	1296,4	555,2	1214,5	615,1	1197,6	628,0
	5	1560,7	418,6	1489,3	460,5	1414,3	507,6	1335,4	560,5	1251,9	620,2	1234,6	633,0
	6	1604,7	424,5	1531,9	466,3	1455,5	513,3	1374,8	566,1	1289,8	625,5	1272,2	638,2
	7	1649,5	430,4	1575,2	472,3	1497,1	519,3	1414,9	571,9	1328,1	631,0	1310,2	643,6
	8	1694,8	436,5	1619,0	478,5	1539,3	525,4	1455,5	577,9	1367,0	636,7	1348,7	649,3
	9	1740,6	442,8	1663,3	484,8	1582,1	531,7	1496,6	584,1	1406,4	642,7	1387,6	655,2
445.3	4	1617,8	441,8	1542,1	486,2	1462,8	536,2	1379,2	592,6	1290,7	656,2	1272,6	669,8
	5	1664,5	448,0	1587,2	492,4	1506,2	542,4	1420,8	598,5	1330,7	661,8	1312,0	675,3
	6	1711,8	454,4	1633,0	498,8	1550,3	548,7	1463,1	604,7	1371,0	667,6	1352,1	681,1
	7	1759,8	460,9	1679,2	505,4	1594,7	555,2	1505,9	611,0	1412,0	673,6	1392,7	687,0
	8	1808,3	467,6	1726,2	512,2	1640,0	561,9	1549,2	617,6	1453,6	680,0	1433,8	693,3
	9	1857,4	474,5	1773,6	519,1	1685,7	568,9	1593,2	624,4	1495,6	686,5	1475,4	699,8
464.3	4	1672,4	475,3	1593,1	523,5	1509,9	577,8	1421,9	639,1	1329,0	708,1	1309,7	722,9
	5	1720,1	482,0	1639,1	530,3	1554,1	584,5	1464,5	645,5	1369,7	714,1	1350,0	728,8
	6	1768,3	489,0	1685,8	537,2	1599,1	591,3	1507,5	652,1	1410,8	720,4	1390,7	735,1
	7	1817,2	496,0	1733,1	544,3	1644,4	598,4	1551,1	659,0	1452,5	727,0	1432,0	741,6
	8	1866,8	503,3	1780,8	551,7	1690,4	605,7	1595,3	666,2	1494,6	733,9	1473,8	748,4
	9	1916,8	510,8	1829,2	559,2	1737,0	613,2	1640,0	673,6	1537,3	741,0	1516,2	755,4
478.3	4	1755,1	490,8	1673,4	540,7	1587,5	597,0	1497,0	660,5	1401,1	732,1	1381,2	747,5
	5	1805,1	497,6	1721,7	547,5	1634,1	603,7	1541,7	667,0	1444,0	738,2	1423,8	753,5
	6	1855,8	504,5	1770,7	554,5	1681,3	610,6	1586,9	673,7	1487,2	744,6	1466,7	759,8
	7	1906,9	511,7	1820,2	561,7	1729,1	617,8	1632,9	680,7	1531,2	751,2	1510,2	766,3
	8	1959,0	519,0	1870,4	569,1	1777,4	625,1	1679,3	687,8	1575,7	758,1	1554,2	773,2
	9	2011,5	526,5	1921,2	576,7	1826,3	632,7	1726,4	695,3	1620,6	765,3	1598,8	780,3

Note: The power input is for compressor only; cooling cap. and power input referred to evap. fouling factor=0,0176m² °C/kW.

Standard ratings McPower XE 228.2 ÷ 395.3 LN, XN

Unit size	Evap. leaving water temp. °C	AIR AMBIENT TEMPERATURE - °C									
		25		30		35		40		42	
		Cooling capacity kW	Power input kW	Cooling capacity kW	Power input kW	Cooling capacity kW	Power input kW	Cooling capacity kW	Power input kW	Cooling capacity kW	Power input kW
228.2	4	835,3	244,9	794,2	271,3	750,8	301,7	704,8	336,5	685,7	351,9
	5	859,4	248,3	817,3	274,6	773,0	304,8	726,2	339,4	706,6	354,6
	6	883,7	251,8	840,8	278,1	795,5	308,1	747,7	342,4	727,7	357,5
	7	908,3	255,4	864,4	281,6	818,2	311,5	769,4	345,6	749,1	360,6
	8	933,3	259,1	888,4	285,3	841,3	315,0	791,5	348,9	770,9	363,8
	9	958,4	262,9	912,8	289,1	864,6	318,7	813,9	352,4	792,7	367,1
255.2	4	932,5	274,7	885,4	302,7	836,1	334,6	784,0	370,8	762,3	386,6
	5	959,3	278,8	911,2	306,8	860,9	338,5	807,6	374,5	785,6	390,2
	6	986,6	283,0	937,5	311,0	886,0	342,6	831,6	378,4	809,1	394,0
	7	1014,1	287,4	964,1	315,3	911,3	346,9	855,9	382,5	833,0	398,0
	8	1042,2	291,9	990,9	319,8	937,2	351,3	880,5	386,7	857,1	402,2
	9	1070,5	296,5	1018,1	324,4	963,2	355,8	905,4	391,1	881,4	406,5
276.2	4	1004,4	300,9	954,0	330,8	900,8	364,6	845,0	402,6	821,8	419,1
	5	1033,1	305,5	981,5	335,4	927,4	369,1	870,4	407,0	846,6	423,4
	6	1062,0	310,2	1009,4	340,2	954,1	373,8	895,8	411,5	871,6	427,9
	7	1091,4	315,1	1037,5	345,1	981,1	378,6	921,5	416,2	896,9	432,5
	8	1121,1	320,1	1066,2	350,1	1008,4	383,6	947,7	421,1	922,6	437,3
	9	1151,1	325,2	1095,0	355,3	1036,1	388,8	974,2	426,2	948,4	442,3
300.2	4	1097,4	332,4	1041,1	365,1	982,1	402,0	919,9	443,6	894,1	461,6
	5	1128,8	337,6	1071,2	370,4	1010,9	407,2	947,5	448,6	921,0	466,5
	6	1160,6	343,0	1101,8	375,8	1040,2	412,5	975,3	453,8	948,3	471,6
	7	1192,7	348,5	1132,7	381,3	1069,8	418,0	1003,5	459,1	976,0	476,9
	8	1225,3	354,1	1164,0	387,0	1099,6	423,7	1032,0	464,7	1003,9	482,4
	9	1258,1	360,0	1195,5	392,9	1129,8	429,5	1060,7	470,4	1032,2	488,1
320.2	4	1167,6	360,2	1107,8	396,0	1044,8	436,4	978,6	481,8	951,0	501,5
	5	1200,7	365,8	1139,6	401,7	1075,3	441,9	1007,5	487,2	979,5	506,8
	6	1234,1	371,6	1171,7	407,5	1106,1	447,6	1037,0	492,7	1008,3	512,3
	7	1268,1	377,5	1204,3	413,4	1137,3	453,6	1066,7	498,5	1037,4	518,0
	8	1302,4	383,6	1237,2	419,5	1168,7	459,7	1096,7	504,5	1066,9	523,9
	9	1337,0	389,9	1270,5	425,8	1200,6	465,9	1127,0	510,7	1096,5	530,0
340.3	4	1226,2	363,6	1166,8	403,6	1104,1	449,4	1037,5	502,3	1009,8	525,6
	5	1260,9	368,5	1200,4	408,3	1136,3	453,9	1068,5	506,3	1040,3	529,4
	6	1296,3	373,5	1234,2	413,2	1169,1	458,6	1099,8	510,6	1071,0	533,5
	7	1331,8	378,6	1268,7	418,2	1202,1	463,4	1131,6	515,1	1102,2	537,8
	8	1367,9	383,9	1303,6	423,5	1235,6	468,5	1163,7	519,8	1133,7	542,3
	9	1404,4	389,4	1338,7	428,9	1269,4	473,7	1196,1	524,8	1165,5	547,1
374.3	4	1327,4	393,7	1261,9	435,1	1192,8	482,4	1120,0	536,5	1089,5	560,2
	5	1365,3	399,3	1298,3	440,7	1227,9	487,8	1153,5	541,4	1122,5	564,9
	6	1403,7	405,0	1335,3	446,4	1263,4	493,3	1187,4	546,6	1155,9	569,9
	7	1442,4	410,9	1372,7	452,2	1299,3	499,0	1221,8	552,1	1189,5	575,2
	8	1481,8	417,0	1410,5	458,3	1335,6	505,0	1256,6	557,7	1223,6	580,7
	9	1521,5	423,3	1448,8	464,6	1372,4	511,1	1291,6	563,6	1258,1	586,5
395.3	4	1395,7	419,1	1327,1	462,5	1254,6	511,7	1178,2	567,5	1146,5	591,9
	5	1435,1	425,1	1365,0	468,5	1291,2	517,6	1213,2	573,1	1180,7	597,3
	6	1475,1	431,4	1403,6	474,7	1328,2	523,6	1248,6	578,9	1215,5	603,0
	7	1515,5	437,8	1442,4	481,1	1365,6	529,9	1284,3	585,0	1250,5	608,9
	8	1556,4	444,3	1481,9	487,7	1403,4	536,4	1320,6	591,2	1286,2	615,1
	9	1597,7	451,1	1521,6	494,4	1441,6	543,1	1357,1	597,8	1322,0	621,5

Note: The power input is for compressor only; cooling cap. and power input referred to evap. fouling factor=0,0176m² °C/kW.

Standard ratings McPower XE 418.3 ÷ 478.3 LN, XN

Unit size	Evap. leaving water temp. °C	AIR AMBIENT TEMPERATURE - °C									
		25		30		35		40		42	
		Cooling capacity kW	Power input kW	Cooling capacity kW	Power input kW	Cooling capacity kW	Power input kW	Cooling capacity kW	Power input kW	Cooling capacity kW	Power input kW
418.3	4	1467,1	442,6	1395,4	487,7	1320,0	538,5	1240,3	595,9	1207,2	620,8
	5	1508,4	449,0	1435,2	494,1	1358,2	544,9	1276,9	602,0	1243,0	626,8
	6	1550,2	455,6	1475,4	500,8	1396,8	551,5	1313,9	608,4	1279,3	633,1
	7	1592,3	462,4	1516,1	507,6	1435,8	558,2	1351,2	615,0	1315,9	639,6
	8	1635,0	469,4	1557,2	514,6	1475,4	565,2	1389,0	621,8	1353,0	646,3
	9	1678,2	476,5	1598,8	521,8	1515,2	572,4	1427,1	628,9	1390,5	653,3
445.3	4	1558,9	476,2	1481,2	524,3	1399,6	578,6	1313,3	639,7	1277,2	666,3
	5	1602,8	483,3	1523,5	531,4	1440,0	585,6	1352,0	646,5	1315,3	672,9
	6	1647,2	490,6	1566,2	538,8	1481,0	592,9	1391,1	653,6	1353,8	679,9
	7	1692,2	498,1	1609,5	546,3	1522,5	600,3	1430,8	660,9	1392,7	687,1
	8	1737,6	505,8	1653,3	554,1	1564,5	608,1	1470,8	668,5	1431,9	694,6
	9	1783,5	513,7	1697,3	562,1	1606,9	616,0	1511,3	676,3	1471,7	702,3
464.3	4	1624,6	503,1	1543,7	554,4	1458,6	612,1	1368,6	677,2	1331,1	705,5
	5	1670,0	510,6	1587,4	561,9	1500,5	619,5	1408,6	684,4	1370,4	712,5
	6	1716,1	518,3	1631,7	569,6	1543,0	627,1	1449,3	691,8	1410,3	719,8
	7	1762,5	526,2	1676,5	577,5	1586,0	635,0	1490,3	699,4	1450,4	727,4
	8	1809,6	534,2	1721,7	585,6	1629,4	643,1	1531,7	707,4	1491,1	735,2
	9	1857,0	542,5	1767,4	594,0	1673,2	651,4	1573,6	715,6	1532,3	743,3
478.3	4	1690,2	530,1	1606,3	584,4	1517,6	645,7	1423,9	714,8	1384,8	744,8
	5	1737,3	537,9	1651,5	592,3	1561,1	653,4	1465,4	722,2	1425,5	752,1
	6	1784,8	546,0	1697,2	600,3	1604,9	661,4	1507,3	730,0	1466,7	759,7
	7	1832,9	554,2	1743,5	608,6	1649,3	669,6	1549,8	738,0	1508,3	767,6
	8	1881,5	562,7	1790,2	617,1	1694,1	678,1	1592,7	746,3	1550,4	775,8
	9	1930,5	571,3	1837,5	625,9	1739,6	686,8	1635,9	754,9	1592,9	784,3

Note: The power input is for compressor only; cooling cap. and power input referred to evap. fouling factor=0,0176m² °C/kW.

Standard ratings McPower XE 228.2 ÷ 395.3 XXN

Unit size	Evap. leaving water temp. °C	AIR AMBIENT TEMPERATURE - °C							
		25		30		35		40	
		Cooling capacity kW	Power input kW	Cooling capacity kW	Power input kW	Cooling capacity kW	Power input kW	Cooling capacity kW	Power input kW
228.2	4	814,1	258,3	772,0	286,5	727,7	318,9	680,6	356,1
	5	837,1	262,0	794,2	290,1	748,8	322,3	700,8	359,3
	6	860,4	265,8	816,5	293,8	770,2	325,9	721,2	362,6
	7	883,9	269,8	839,1	297,7	791,9	329,6	741,8	366,0
	8	907,6	273,8	861,9	301,7	813,8	333,5	762,7	369,6
255.2	4	906,9	289,6	859,0	319,4	808,6	353,3	755,3	391,8
	5	932,6	294,1	883,6	323,9	832,1	357,6	777,7	395,9
	6	958,5	298,8	908,6	328,5	855,9	362,1	800,4	400,1
	7	984,8	303,5	933,8	333,2	880,0	366,7	823,4	404,6
	8	1011,4	308,4	959,1	338,1	904,2	371,5	846,5	409,2
276.2	4	976,4	317,3	924,9	349,0	870,9	384,7	813,8	424,9
	5	1003,7	322,3	951,1	354,0	895,9	389,7	837,6	429,7
	6	1031,2	327,5	977,6	359,2	921,1	394,8	861,6	434,7
	7	1059,3	332,8	1004,4	364,5	946,8	400,1	885,9	439,9
	8	1087,4	338,2	1031,3	370,0	972,5	405,6	910,5	445,2
300.2	4	1064,9	351,0	1007,6	385,8	947,5	424,9	883,8	468,9
	5	1094,8	356,7	1036,3	391,5	974,6	430,5	909,8	474,4
	6	1125,0	362,6	1065,1	397,4	1002,2	436,3	936,0	480,0
	7	1155,5	368,6	1094,3	403,4	1030,1	442,4	962,3	485,9
	8	1186,3	374,8	1123,8	409,7	1058,1	448,5	989,0	492,0
320.2	4	1132,6	380,9	1071,5	418,9	1007,3	461,8	939,5	510,0
	5	1164,0	387,0	1101,7	425,1	1036,1	467,8	966,8	515,9
	6	1195,8	393,4	1132,1	431,4	1065,0	474,1	994,3	522,0
	7	1227,9	399,9	1162,9	438,0	1094,3	480,6	1022,1	528,3
	8	1260,4	406,6	1193,9	444,7	1123,9	487,3	1050,2	534,8
340.3	4	1196,0	383,5	1135,3	426,1	1071,0	475,1	1002,8	531,5
	5	1229,4	388,8	1167,4	431,2	1101,9	480,0	1032,3	536,0
	6	1263,2	394,2	1200,1	436,6	1133,1	485,1	1062,1	540,6
	7	1297,3	399,9	1232,9	442,1	1164,6	490,4	1092,2	545,6
	8	1331,9	405,7	1266,1	447,8	1196,6	495,9	1122,7	550,7
374.3	4	1292,9	415,1	1226,0	459,3	1155,5	509,6	1080,7	567,2
	5	1329,1	421,2	1260,8	465,3	1188,8	515,4	1112,5	572,6
	6	1365,8	427,5	1296,0	471,5	1222,5	521,5	1144,6	578,3
	7	1402,9	434,0	1331,7	478,0	1256,7	527,7	1177,3	584,2
	8	1440,4	440,7	1367,6	484,6	1291,0	534,2	1210,1	590,4
395.3	4	1358,9	441,9	1288,8	488,0	1214,9	540,2	1136,7	599,5
	5	1396,7	448,5	1325,1	494,6	1249,7	546,7	1169,8	605,6
	6	1434,9	455,3	1361,9	501,4	1284,7	553,3	1203,2	612,0
	7	1473,5	462,3	1398,9	508,4	1320,3	560,2	1237,1	618,6
	8	1512,5	469,5	1436,3	515,6	1356,1	567,3	1271,2	625,5
395.3	9	1551,8	476,9	1474,1	523,0	1392,3	574,6	1305,7	632,6

Note: The power input is for compressor only; cooling cap. and power input referred to evap. fouling factor=0,0176m² °C/kW.

Standard ratings McPower XE 418.3 ÷ 478.3 XXN

Unit size	Evap. leaving water temp. °C	AIR AMBIENT TEMPERATURE - °C							
		25		30		35		40	
		Cooling capacity kW	Power input kW	Cooling capacity kW	Power input kW	Cooling capacity kW	Power input kW	Cooling capacity kW	Power input kW
418.3	4	1431,6	464,6	1358,6	512,2	1281,4	565,8	1200,0	626,2
	5	1471,1	471,6	1396,6	519,2	1317,9	572,7	1234,7	632,9
	6	1511,1	478,8	1435,0	526,4	1354,8	579,9	1269,9	639,9
	7	1551,6	486,2	1473,8	533,9	1391,9	587,2	1305,3	647,1
	8	1592,5	493,8	1513,2	541,5	1429,5	594,8	1341,2	654,5
445.3	4	1515,6	502,6	1436,4	553,6	1352,8	611,2	1264,4	676,0
	5	1557,5	510,4	1476,6	561,4	1391,2	618,9	1301,0	683,4
	6	1599,9	518,4	1517,2	569,5	1430,2	626,8	1338,0	691,2
	7	1642,6	526,6	1558,2	577,8	1469,3	635,1	1375,4	699,2
	8	1685,8	535,1	1599,7	586,3	1508,8	643,5	1413,1	707,5
464.3	4	1579,2	531,5	1496,6	585,9	1409,3	647,2	1317,1	716,3
	5	1622,5	539,7	1538,1	594,1	1449,1	655,3	1354,9	724,2
	6	1666,3	548,2	1580,2	602,6	1489,3	663,7	1393,2	732,3
	7	1710,4	556,8	1622,6	611,3	1529,9	672,3	1431,8	740,7
	8	1755,2	565,7	1665,4	620,2	1570,8	681,2	1470,7	749,4
478.3	4	1642,6	560,5	1556,7	618,2	1465,9	683,3	1369,6	756,7
	5	1687,4	569,1	1599,7	626,8	1507,0	691,8	1408,7	764,9
	6	1732,8	577,9	1643,2	635,7	1548,5	700,6	1448,3	773,4
	7	1778,4	587,0	1686,9	644,8	1590,4	709,6	1488,1	782,2
	8	1824,5	596,3	1731,2	654,2	1632,8	718,9	1528,4	791,4
	9	1871,1	605,8	1775,9	663,8	1675,4	728,5	1569,1	800,8

Note: The power input is for compressor only; cooling cap. and power input referred to evap. fouling factor=0,0176m² °C/kW.

Evaporator Pressure Drop – McPower 228.2 ÷ 478.3

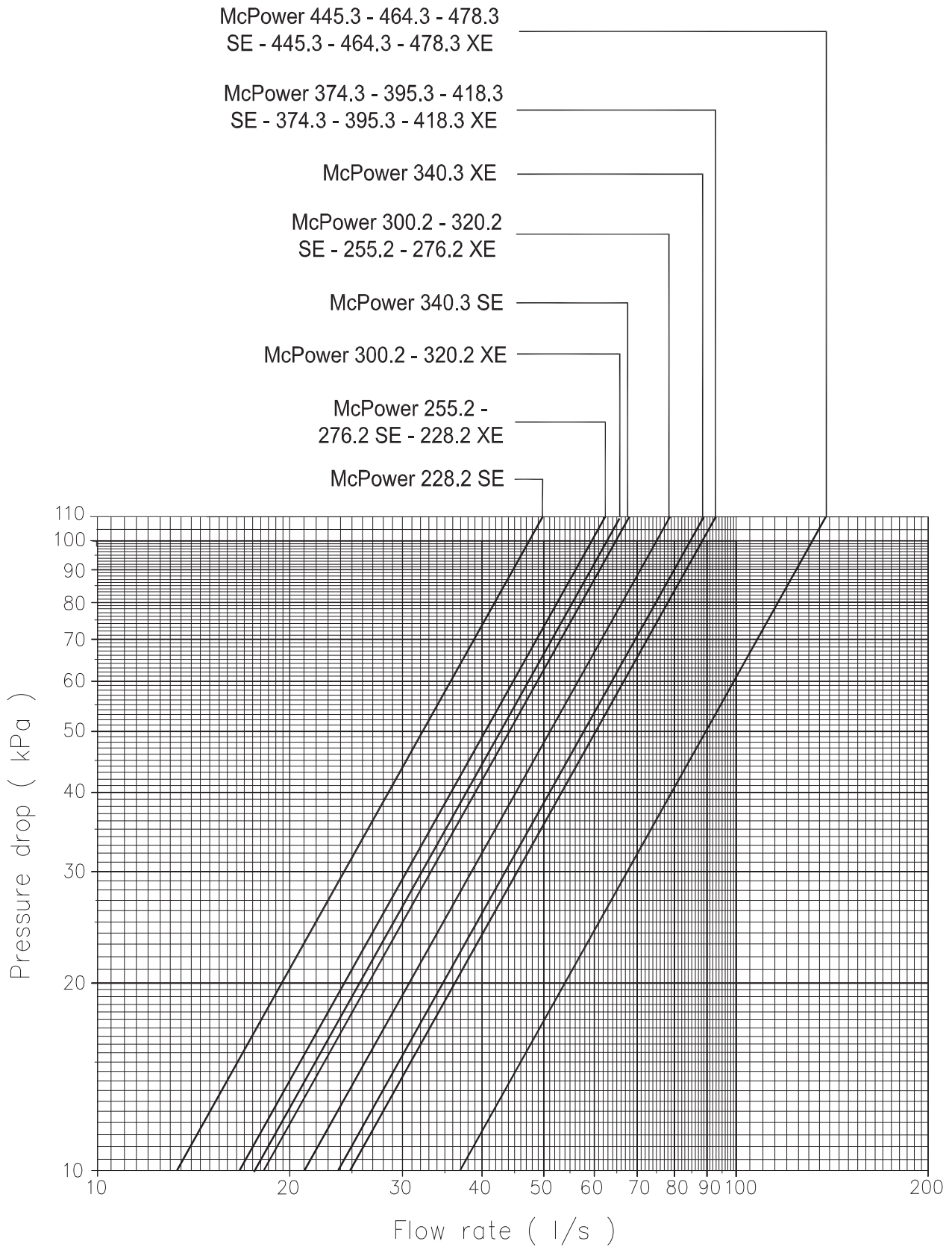

Water Pump Diagram

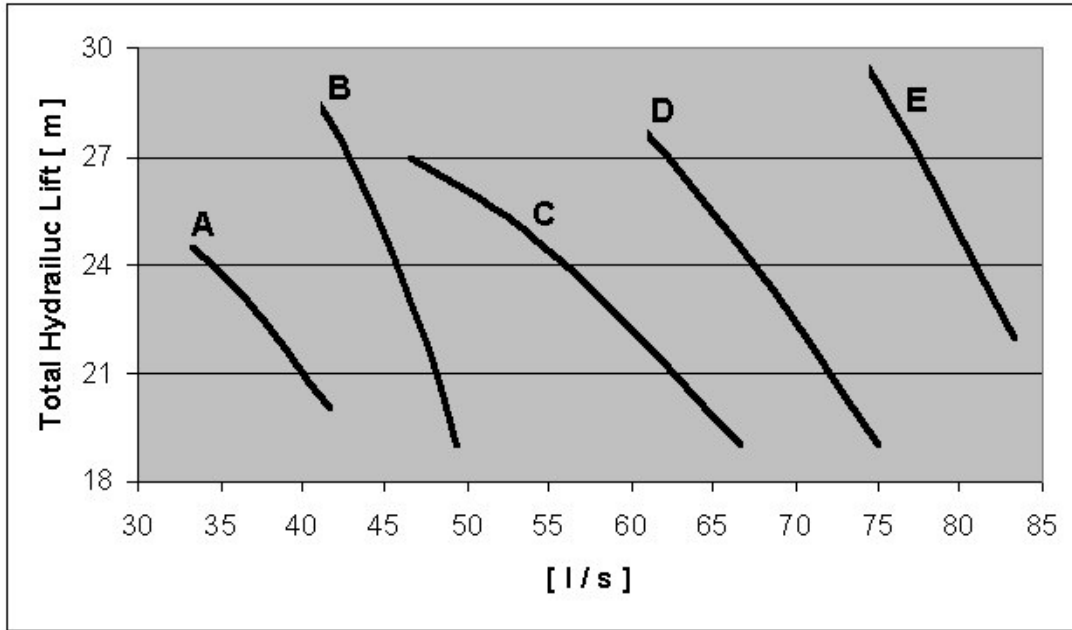

Note: to have the useful hydraulic lift is necessary to subtract the evaporator pressure drop to the total hydraulic lift

Unit size	SE ST / CN	SE LN / XN	SE XXN	XE ST / CN	XE LN / XN	XE XXN
	Type pump			Type pump		
228.2	A	A	A	A	A	A
255.2	A	A	A	B	A	A
276.2	B	B	A	B	B	B
300.2	B	B	B	C	C	B
320.2	C	C	B	C	C	C
340.2	C	C	C	C	C	C
374.3	C	C	C	C	C	C
395.3	C	C	C	D	C	C
418.3	D	D	C	D	D	D
445.3	D	D	D	E	D	D
464.3	E	E	D	E	E	D
478.3	E	E	D	E	E	E

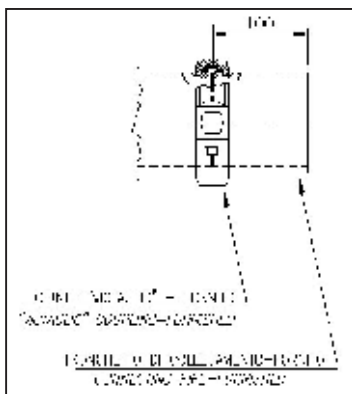

Note: Victaulic kit for the water pump(s) discharge line is furnished.

Partial Heat Recovery Ratings McPower 228.2÷478.3

McPower unit size		LEAVING DESUPERHEATERS WATER TEMPERATURE – °C		
		45	50	55
		Heating capacity (kW)	Heating capacity (kW)	Heating capacity (kW)
228.2	Leaving chilled water temperature 7°C ΔT 5°C – Air temperature 35 °C	165	133	99
255.2		181	146	108
276.2		197	160	118
300.2		212	172	127
320.2		228	185	137
340.3		247	200	148
374.3		263	213	158
395.3		279	226	168
418.3		295	239	177
445.3		311	252	187
464.3		326	264	196
478.3		342	277	205

Partial Heat Recovery Exchanger (Plate Exchanger) Pressure Drop

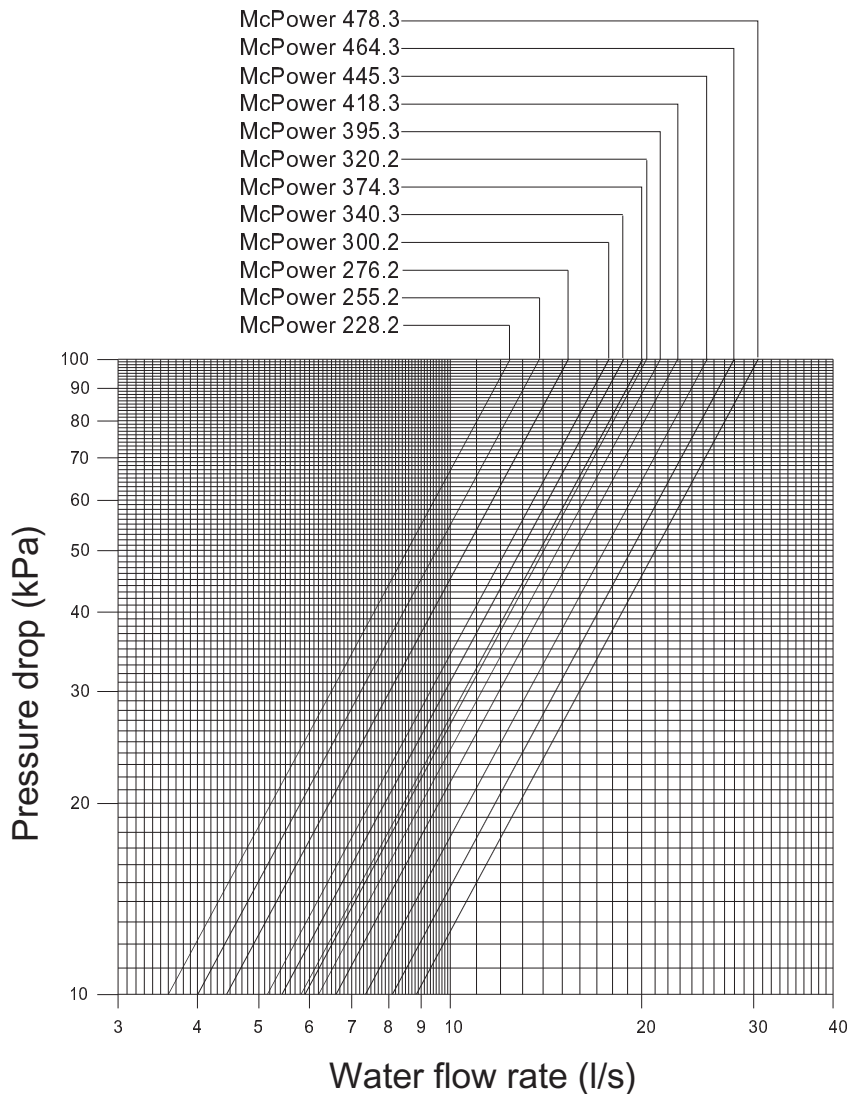

Total Heat Recovery Ratings – McPower SE 228.2÷395.3

McPower unit size	Evap. leaving water temp. °C	Heat recovery leaving water temperature - °C											
		40			45			50			55		
		Cooling capac. (kW)	Power input (KW)	Recov. capac. (kW)	Cooling capac. (kW)	Power input (KW)	Recov. capac. (kW)	Cooling capac. (kW)	Power input (KW)	Recov. capac. (kW)	Cooling capac. (kW)	Power input (KW)	Recov. capac. (kW)
228.2	4	783,8	265,6	1049,4	741,3	296,3	1037,6	696,4	331,7	1028,1	648,9	372,2	1021,1
	5	808,1	267,5	1075,6	764,8	297,9	1062,7	719,1	332,9	1052,0	670,6	372,9	1043,5
	6	832,9	269,5	1102,4	788,8	299,7	1088,5	742,1	334,2	1076,3	692,7	373,7	1066,4
	7	858,1	271,6	1129,7	813,1	301,5	1114,6	765,5	335,7	1101,2	715,2	374,8	1090,0
	8	883,6	273,8	1157,4	837,7	303,5	1141,2	789,3	337,4	1126,7	738,0	376,0	1114,0
	9	909,6	276,2	1185,8	862,8	305,6	1168,4	813,4	339,2	1152,6	761,1	377,4	1138,5
255.2	4	870,4	291,3	1161,7	823,1	323,4	1146,5	773,2	360,0	1133,2	720,4	401,5	1121,9
	5	897,6	293,7	1191,3	849,3	325,6	1174,9	798,4	361,8	1160,2	744,6	402,9	1147,5
	6	925,2	296,2	1221,4	875,9	327,9	1203,8	824,0	363,8	1187,8	769,1	404,5	1173,6
	7	953,2	298,8	1252,0	903,0	330,3	1233,3	850,0	365,9	1215,9	794,1	406,2	1200,3
	8	981,6	301,5	1283,1	930,4	332,8	1263,2	876,5	368,1	1244,6	819,4	408,1	1227,5
	9	1010,5	304,3	1314,8	958,3	335,4	1293,7	903,3	370,5	1273,8	845,1	410,1	1255,2
276.2	4	939,5	315,7	1255,2	889,0	349,5	1238,5	835,7	387,6	1223,3	779,3	430,5	1209,8
	5	968,4	318,4	1286,8	917,0	352,0	1269,0	862,6	389,9	1252,5	805,2	432,5	1237,7
	6	997,9	321,3	1319,2	945,4	354,7	1300,1	890,0	392,3	1282,3	831,4	434,6	1266,0
	7	1027,8	324,2	1352,0	974,2	357,5	1331,7	917,8	394,9	1312,7	858,1	436,8	1294,9
	8	1058,1	327,2	1385,3	1003,5	360,4	1363,9	946,0	397,6	1343,6	885,2	439,2	1324,4
	9	1088,9	330,4	1419,3	1033,3	363,4	1396,7	974,6	400,4	1375,0	912,7	441,8	1354,5
300.2	4	1024,6	343,9	1368,5	969,2	380,6	1349,8	910,8	421,9	1332,7	849,1	468,5	1317,6
	5	1056,3	346,9	1403,2	999,9	383,4	1383,3	940,3	424,5	1364,8	877,3	470,7	1348,0
	6	1088,5	350,0	1438,5	1030,9	386,3	1417,2	970,2	427,2	1397,4	906,0	473,1	1379,1
	7	1121,2	353,3	1474,5	1062,5	389,4	1451,9	1000,6	430,0	1430,6	935,1	475,6	1410,7
	8	1154,4	356,6	1511,0	1094,6	392,6	1487,2	1031,5	433,0	1464,5	964,7	478,3	1443,0
	9	1188,1	360,1	1548,2	1127,1	396,0	1523,1	1062,8	436,1	1498,9	994,8	481,1	1475,9
320.2	4	1091,0	370,3	1461,3	1032,5	410,1	1442,6	970,8	455,0	1425,8	905,4	505,6	1411,0
	5	1124,5	373,5	1498,0	1064,9	413,1	1478,0	1001,9	457,7	1459,6	935,3	507,8	1443,1
	6	1158,5	376,8	1535,3	1097,7	416,2	1513,9	1033,5	460,5	1494,0	965,6	510,3	1475,9
	7	1193,0	380,2	1573,2	1131,0	419,4	1550,4	1065,6	463,5	1529,1	996,4	512,9	1509,3
	8	1228,0	383,7	1611,7	1164,9	422,8	1587,7	1098,2	466,6	1564,8	1027,7	515,7	1543,4
	9	1263,5	387,4	1650,9	1199,2	426,3	1625,5	1131,3	469,9	1601,2	1059,5	518,7	1578,2
340.3	4	1145,4	396,1	1541,5	1084,5	442,7	1527,2	1020,0	496,3	1516,3	951,4	557,8	1509,2
	5	1180,4	398,8	1579,2	1118,4	444,9	1563,3	1052,7	497,9	1550,6	982,9	558,6	1541,5
	6	1216,0	401,6	1617,6	1152,8	447,3	1600,1	1085,8	499,7	1585,5	1014,8	559,6	1574,4
	7	1252,2	404,5	1656,7	1187,7	449,9	1637,6	1119,5	501,7	1621,2	1047,1	561,0	1608,1
	8	1288,8	407,6	1696,4	1223,2	452,6	1675,8	1153,7	504,0	1657,7	1080,0	562,5	1642,5
	9	1326,0	410,8	1736,8	1259,2	455,5	1714,7	1188,4	506,4	1694,8	1113,4	564,3	1677,7
374.3	4	1278,0	425,4	1703,4	1207,9	472,6	1680,5	1134,1	526,6	1660,7	1056,0	588,1	1644,1
	5	1318,1	428,8	1746,9	1246,6	475,7	1722,3	1171,3	529,1	1700,4	1091,7	589,9	1681,6
	6	1358,9	432,5	1791,4	1286,0	478,9	1764,9	1209,2	531,8	1741,0	1127,9	592,0	1719,9
	7	1400,4	436,2	1836,6	1326,0	482,4	1808,4	1247,6	534,8	1782,4	1164,8	594,3	1759,1
	8	1442,5	440,2	1882,7	1366,6	486,0	1852,6	1286,7	538,0	1824,7	1202,2	597,0	1799,2
	9	1485,3	444,3	1929,6	1407,9	489,9	1897,8	1326,3	541,5	1867,8	1240,2	599,8	1840,0
395.3	4	1347,7	449,9	1797,6	1274,4	498,8	1773,2	1197,2	554,2	1751,4	1115,5	617,1	1732,6
	5	1389,7	453,7	1843,4	1315,0	502,2	1817,2	1236,2	557,3	1793,5	1152,9	619,5	1772,4
	6	1432,5	457,6	1890,1	1356,2	505,9	1862,1	1275,8	560,5	1836,3	1190,8	622,2	1813,0
	7	1475,8	461,7	1937,5	1398,1	509,7	1907,8	1316,1	563,9	1880,0	1229,4	625,1	1854,5
	8	1519,9	466,0	1985,9	1440,6	513,8	1954,4	1357,0	567,6	1924,6	1268,7	628,3	1897,0
	9	1564,6	470,4	2035,0	1483,7	518,0	2001,7	1398,5	571,5	1970,0	1308,5	631,6	1940,1

Total Heat Recovery Ratings – McPower SE 418.3÷478.3

McPower unit size	Evap. leaving water temp. °C	Heat recovery leaving water temperature - °C											
		40			45			50			55		
		Cooling capac. (kW)	Power input (KW)	Recov. capac. (kW)	Cooling capac. (kW)	Power input (KW)	Recov. capac. (kW)	Cooling capac. (kW)	Power input (KW)	Recov. capac. (kW)	Cooling capac. (kW)	Power input (KW)	Recov. capac. (kW)
418.3	4	1417,5	474,3	1891,8	1341,0	524,9	1865,9	1260,3	581,9	1842,2	1175,0	646,2	1821,2
	5	1461,4	478,5	1939,9	1383,3	528,8	1912,1	1301,1	585,4	1886,5	1214,1	649,2	1863,3
	6	1506,0	482,8	1988,8	1426,4	532,8	1959,2	1342,5	589,1	1931,6	1253,8	652,4	1906,2
	7	1551,2	487,2	2038,4	1470,1	537,1	2007,2	1384,6	593,0	1977,6	1294,1	655,9	1950,0
	8	1597,2	491,9	2089,1	1514,5	541,5	2056,0	1427,3	597,2	2024,5	1335,1	659,5	1994,6
	9	1643,9	496,6	2140,5	1559,5	546,1	2105,6	1470,6	601,5	2072,1	1376,7	663,5	2040,2
445.3	4	1515,0	503,7	2018,7	1432,5	557,0	1989,5	1345,5	617,1	1962,6	1253,6	684,9	1938,5
	5	1562,3	508,2	2070,5	1478,1	561,2	2039,3	1389,3	621,0	2010,3	1295,6	688,2	1983,8
	6	1610,3	512,9	2123,2	1524,4	565,7	2090,1	1433,9	625,0	2058,9	1338,2	691,7	2029,9
	7	1659,1	517,8	2176,9	1571,4	570,3	2141,7	1479,1	629,3	2108,4	1381,6	695,5	2077,1
	8	1708,6	522,8	2231,4	1619,2	575,1	2194,3	1525,1	633,8	2158,9	1425,6	699,6	2125,2
	9	1758,9	528,0	2286,9	1667,7	580,2	2247,9	1571,7	638,5	2210,2	1470,4	703,9	2174,3
464.3	4	1582,5	530,2	2112,7	1496,7	586,6	2083,3	1406,3	650,3	2056,6	1310,6	722,0	2032,6
	5	1631,6	534,9	2166,5	1544,1	591,0	2135,1	1451,8	654,2	2106,0	1354,3	725,4	2079,7
	6	1681,4	539,8	2221,2	1592,2	595,6	2187,8	1498,1	658,4	2156,5	1398,7	729,0	2127,7
	7	1732,0	544,8	2276,8	1641,0	600,4	2241,4	1545,1	662,9	2208,0	1443,7	733,0	2176,7
	8	1783,4	550,0	2333,4	1690,6	605,4	2296,0	1592,9	667,5	2260,4	1489,5	737,1	2226,6
	9	1835,6	555,4	2391,0	1741,0	610,6	2351,6	1641,3	672,4	2313,7	1536,0	741,6	2277,6
478.3	4	1649,9	556,8	2206,7	1560,9	616,3	2177,2	1467,1	683,4	2150,5	1367,7	759,1	2126,8
	5	1700,8	561,6	2262,4	1610,1	620,8	2230,9	1514,3	687,5	2201,8	1413,1	762,6	2175,7
	6	1752,5	566,6	2319,1	1660,0	625,5	2285,5	1562,4	691,8	2254,2	1459,1	766,3	2225,4
	7	1804,9	571,8	2376,7	1710,6	630,5	2341,1	1611,1	696,4	2307,5	1505,9	770,4	2276,3
	8	1858,2	577,2	2435,4	1762,1	635,7	2397,8	1660,6	701,2	2361,8	1553,4	774,7	2328,1
	9	1912,2	582,8	2495,0	1814,2	641,0	2455,2	1710,9	706,3	2417,2	1601,6	779,3	2380,9

Total Heat Recovery Ratings – McPower XE 228.2÷395.3

McPower unit size	Evap. leaving water temp. °C	Heat recovery leaving water temperature - °C											
		40			45			50			55		
		Cooling capac. (kW)	Power input (KW)	Recov. capac. (kW)	Cooling capac. (kW)	Power input (KW)	Recov. capac. (kW)	Cooling capac. (kW)	Power input (KW)	Recov. capac. (kW)	Cooling capac. (kW)	Power input (KW)	Recov. capac. (kW)
228.2	4	801,4	267,0	1068,4	757,3	297,4	1054,7	710,7	332,4	1043,1	661,5	372,6	1034,1
	5	826,7	269,0	1095,7	781,7	299,2	1080,9	734,2	333,7	1067,9	683,9	373,4	1057,3
	6	852,5	271,2	1123,7	806,5	301,0	1107,5	758,0	335,2	1093,2	706,8	374,4	1081,2
	7	878,6	273,4	1152,0	831,7	303,0	1134,7	782,3	336,9	1119,2	730,0	375,5	1105,5
	8	905,2	275,8	1181,0	857,3	305,2	1162,5	806,9	338,7	1145,6	753,6	376,9	1130,5
	9	932,2	278,2	1210,4	883,3	307,4	1190,7	831,9	340,6	1172,5	777,6	378,4	1156,0
255.2	4	900,5	294,0	1194,5	850,2	325,7	1175,9	797,4	361,8	1159,2	741,6	402,8	1144,4
	5	929,2	296,6	1225,8	877,9	328,1	1206,0	824,0	363,8	1187,8	767,0	404,4	1171,4
	6	958,5	299,3	1257,8	906,1	330,6	1236,7	851,0	366,0	1217,0	792,9	406,1	1199,0
	7	988,2	302,1	1290,3	934,7	333,2	1267,9	878,4	368,3	1246,7	819,1	408,1	1227,2
	8	1018,4	305,1	1323,5	963,8	336,0	1299,8	906,4	370,8	1277,2	845,9	410,2	1256,1
	9	1049,1	308,2	1357,3	993,3	338,9	1332,2	934,7	373,5	1308,2	873,0	412,5	1285,5
276.2	4	974,4	319,0	1293,4	920,5	352,4	1272,9	863,9	390,0	1253,9	804,2	432,4	1236,6
	5	1005,2	322,0	1327,2	950,2	355,1	1305,3	892,4	392,5	1284,9	831,5	434,6	1266,1
	6	1036,5	325,1	1361,6	980,4	358,1	1338,5	921,4	395,2	1316,6	859,2	436,9	1296,1
	7	1068,3	328,3	1396,6	1011,0	361,1	1372,1	950,8	398,0	1348,8	887,4	439,4	1326,8
	8	1100,6	331,6	1432,2	1042,2	364,3	1406,5	980,7	401,0	1381,7	916,0	442,1	1358,1
	9	1133,4	335,0	1468,4	1073,8	367,6	1441,4	1011,1	404,1	1415,2	945,1	445,0	1390,1
300.2	4	1070,4	348,3	1418,7	1010,6	384,4	1395,0	947,8	425,1	1372,9	881,5	471,0	1352,5
	5	1104,6	351,6	1456,2	1043,5	387,5	1431,0	979,3	428,0	1407,3	911,6	473,5	1385,1
	6	1139,3	355,1	1494,4	1076,9	390,8	1467,7	1011,3	431,0	1442,3	942,3	476,2	1418,5
	7	1174,6	358,7	1533,3	1110,8	394,3	1505,1	1043,9	434,2	1478,1	973,4	479,1	1452,5
	8	1210,4	362,4	1572,8	1145,4	397,9	1543,3	1077,0	437,6	1514,6	1005,1	482,1	1487,2
	9	1246,8	366,3	1613,1	1180,4	401,6	1582,0	1110,7	441,1	1551,8	1037,3	485,3	1522,6
320.2	4	1143,0	375,3	1518,3	1079,5	414,4	1493,9	1012,8	458,6	1471,4	942,4	508,4	1450,8
	5	1179,1	378,8	1557,9	1114,4	417,8	1532,2	1046,2	461,6	1507,8	974,4	511,0	1485,4
	6	1215,9	382,5	1598,4	1149,8	421,3	1571,1	1080,2	464,8	1545,0	1006,9	513,8	1520,7
	7	1253,3	386,3	1639,6	1185,8	424,9	1610,7	1114,8	468,2	1583,0	1040,0	516,9	1556,9
	8	1291,2	390,3	1681,5	1222,3	428,7	1651,0	1149,9	471,8	1621,7	1073,5	520,1	1593,6
	9	1329,8	394,3	1724,1	1259,4	432,6	1692,0	1185,5	475,5	1661,0	1107,7	523,5	1631,2
340.3	4	1175,2	398,4	1573,6	1111,6	444,5	1556,1	1044,3	497,5	1541,8	973,0	558,3	1531,3
	5	1211,8	401,2	1613,0	1146,9	446,9	1593,8	1078,3	499,3	1577,6	1005,6	559,3	1564,9
	6	1248,9	404,2	1653,1	1182,7	449,5	1632,2	1112,8	501,3	1614,1	1038,7	560,6	1599,3
	7	1286,6	407,4	1694,0	1219,2	452,3	1671,5	1147,9	503,6	1651,5	1072,4	562,1	1634,5
	8	1324,9	410,7	1735,6	1256,1	455,2	1711,3	1183,5	506,0	1689,5	1106,6	564,0	1670,6
	9	1363,8	414,2	1778,0	1293,7	458,4	1752,1	1219,7	508,7	1728,4	1141,3	566,0	1707,3
374.3	4	1278,0	425,4	1703,4	1207,9	472,6	1680,5	1134,1	526,6	1660,7	1056,0	588,1	1644,1
	5	1318,1	428,8	1746,9	1246,6	475,7	1722,3	1171,3	529,1	1700,4	1091,7	589,9	1681,6
	6	1358,9	432,5	1791,4	1286,0	478,9	1764,9	1209,2	531,8	1741,0	1127,9	592,0	1719,9
	7	1400,4	436,2	1836,6	1326,0	482,4	1808,4	1247,6	534,8	1782,4	1164,8	594,3	1759,1
	8	1442,5	440,2	1882,7	1366,6	486,0	1852,6	1286,7	538,0	1824,7	1202,2	597,0	1799,2
	9	1485,3	444,3	1929,6	1407,9	489,9	1897,8	1326,3	541,5	1867,8	1240,2	599,8	1840,0
395.3	4	1347,7	449,9	1797,6	1274,4	498,8	1773,2	1197,2	554,2	1751,4	1115,5	617,1	1732,6
	5	1389,7	453,7	1843,4	1315,0	502,2	1817,2	1236,2	557,3	1793,5	1152,9	619,5	1772,4
	6	1432,5	457,6	1890,1	1356,2	505,9	1862,1	1275,8	560,5	1836,3	1190,8	622,2	1813,0
	7	1475,8	461,7	1937,5	1398,1	509,7	1907,8	1316,1	563,9	1880,0	1229,4	625,1	1854,5
	8	1519,9	466,0	1985,9	1440,6	513,8	1954,4	1357,0	567,6	1924,6	1268,7	628,3	1897,0
	9	1564,6	470,4	2035,0	1483,7	518,0	2001,7	1398,5	571,5	1970,0	1308,5	631,6	1940,1

Total Heat Recovery Ratings – McPower XE 418.3÷478.3

McPower unit size	Evap. leaving water temp. °C	Heat recovery leaving water temperature - °C											
		40			45			50			55		
		Cooling capac. (kW)	Power input (KW)	Recov. capac. (kW)	Cooling capac. (kW)	Power input (KW)	Recov. capac. (kW)	Cooling capac. (kW)	Power input (KW)	Recov. capac. (kW)	Cooling capac. (kW)	Power input (KW)	Recov. capac. (kW)
418.3	4	1417,5	474,3	1891,8	1341,0	524,9	1865,9	1260,3	581,9	1842,2	1175,0	646,2	1821,2
	5	1461,4	478,5	1939,9	1383,3	528,8	1912,1	1301,1	585,4	1886,5	1214,1	649,2	1863,3
	6	1506,0	482,8	1988,8	1426,4	532,8	1959,2	1342,5	589,1	1931,6	1253,8	652,4	1906,2
	7	1551,2	487,2	2038,4	1470,1	537,1	2007,2	1384,6	593,0	1977,6	1294,1	655,9	1950,0
	8	1597,2	491,9	2089,1	1514,5	541,5	2056,0	1427,3	597,2	2024,5	1335,1	659,5	1994,6
	9	1643,9	496,6	2140,5	1559,5	546,1	2105,6	1470,6	601,5	2072,1	1376,7	663,5	2040,2
445.3	4	1515,0	503,7	2018,7	1432,5	557,0	1989,5	1345,5	617,1	1962,6	1253,6	684,9	1938,5
	5	1562,3	508,2	2070,5	1478,1	561,2	2039,3	1389,3	621,0	2010,3	1295,6	688,2	1983,8
	6	1610,3	512,9	2123,2	1524,4	565,7	2090,1	1433,9	625,0	2058,9	1338,2	691,7	2029,9
	7	1659,1	517,8	2176,9	1571,4	570,3	2141,7	1479,1	629,3	2108,4	1381,6	695,5	2077,1
	8	1708,6	522,8	2231,4	1619,2	575,1	2194,3	1525,1	633,8	2158,9	1425,6	699,6	2125,2
	9	1758,9	528,0	2286,9	1667,7	580,2	2247,9	1571,7	638,5	2210,2	1470,4	703,9	2174,3
464.3	4	1582,5	530,2	2112,7	1496,7	586,6	2083,3	1406,3	650,3	2056,6	1310,6	722,0	2032,6
	5	1631,6	534,9	2166,5	1544,1	591,0	2135,1	1451,8	654,2	2106,0	1354,3	725,4	2079,7
	6	1681,4	539,8	2221,2	1592,2	595,6	2187,8	1498,1	658,4	2156,5	1398,7	729,0	2127,7
	7	1732,0	544,8	2276,8	1641,0	600,4	2241,4	1545,1	662,9	2208,0	1443,7	733,0	2176,7
	8	1783,4	550,0	2333,4	1690,6	605,4	2296,0	1592,9	667,5	2260,4	1489,5	737,1	2226,6
	9	1835,6	555,4	2391,0	1741,0	610,6	2351,6	1641,3	672,4	2313,7	1536,0	741,6	2277,6
478.3	4	1649,9	556,8	2206,7	1560,9	616,3	2177,2	1467,1	683,4	2150,5	1367,7	759,1	2126,8
	5	1700,8	561,6	2262,4	1610,1	620,8	2230,9	1514,3	687,5	2201,8	1413,1	762,6	2175,7
	6	1752,5	566,6	2319,1	1660,0	625,5	2285,5	1562,4	691,8	2254,2	1459,1	766,3	2225,4
	7	1804,9	571,8	2376,7	1710,6	630,5	2341,1	1611,1	696,4	2307,5	1505,9	770,4	2276,3
	8	1858,2	577,2	2435,4	1762,1	635,7	2397,8	1660,6	701,2	2361,8	1553,4	774,7	2328,1
	9	1912,2	582,8	2495,0	1814,2	641,0	2455,2	1710,9	706,3	2417,2	1601,6	779,3	2380,9

Total Heat Recovery Exchanger Pressure Drop – McPower 228.2÷478.3

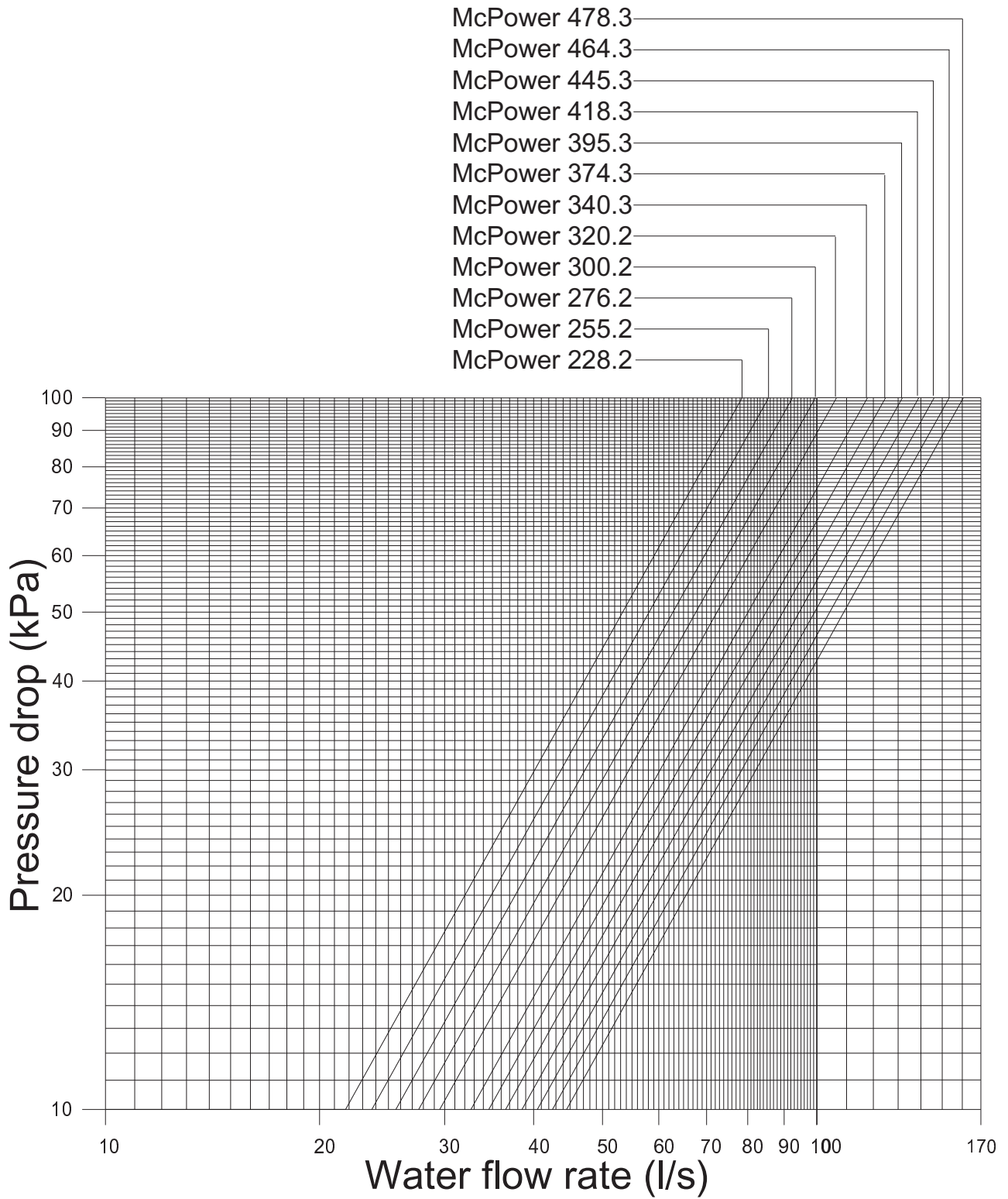

Dimensions McPower SE, XE 228.2 ÷ 320.2 ST, CN, LN, XN, XXN

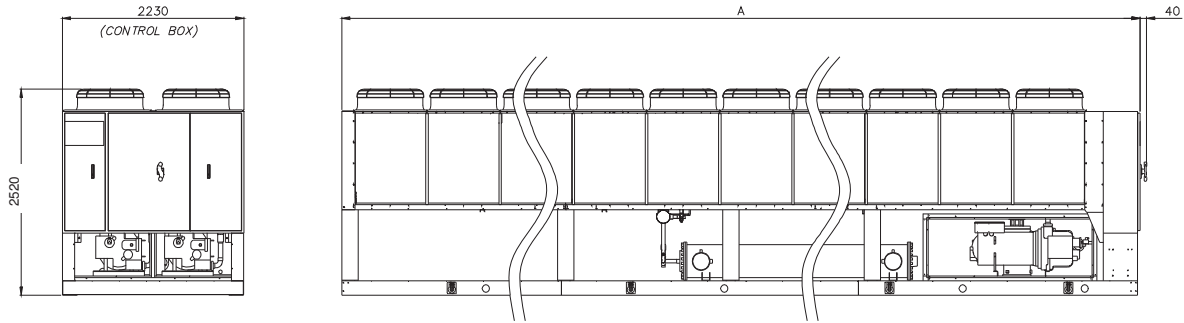

McPower SE Units	Length – A (mm)	McPower XE Units	Length – A (mm)
ST-CN-LN-XN-XXN		ST-CN-LN-XN-XXN	
McPower SE 228.2	6210	McPower XE 228.2	8010
McPower SE 255.2 – 276.2	7110	McPower XE 255.2 - 276.2	8910
McPower SE 300.2 – 320.2	8010	McPower XE 300.2 - 320.2	9810

Dimensions McPower SE 340.3 ÷ 478.3 ST, CN, LN, XN, XXN Dimensions McPower XE 340.3 ÷ 445.3 ST, CN, LN, XN, XXN

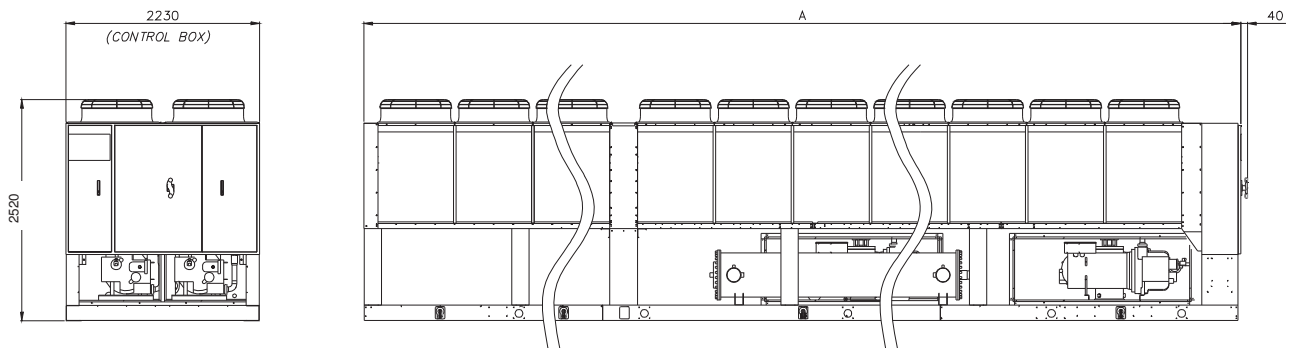

McPower SE Units	Length – A (mm)	McPower XE Units	Length – A (mm)
ST-CN-LN-XN-XXN		ST-CN-LN-XN-XXN	
McPower SE 340.3	9170	McPower XE 340.3	11870
McPower SE 374.3 – 395.3	10070	McPower XE 374.3 – 395.3	12770
McPower SE 418.3 – 445.3	10970	McPower XE 418.3 – 445.3	13670
McPower SE 464.3 – 478.3	11870		

Technical Specification Air Cooled Screw Chiller – McPower 228.2÷478.3

To supply and install, where specified in the project n° unit(s) air cooled water chiller with cooling capacity of kW, to cool l/sec. of water from °C to °C working with °C ambient temperature.

The unit should work with electricity at V, 3ph, 50Hz. The electrical power absorbed should not exceed kW. The units COP will be at least at the working conditions of the project. Part load COP will be at least at the working conditions of the project.

The units will have 2 or 3 independent refrigerant circuits, and the respective electronic microprocessor will allow the starting of the compressors. Each chiller will be factory assembled on a robust baseframe made of zinc coated steel, protected by an epoxy paint.

The unit will be tested at full load in the factory at the nominal working conditions and water temperatures. Before shipment a full test will be held to avoid any losses. Chiller will be delivered to the job site completely assembled and charged with refrigerant and oil.

Comply with the manufacturer instructions for rigging and handling equipment.

GENERAL

All units should be designed and manufactured in accordance with applicable selections of the following which are equivalent to American Air-conditioning industry applicable codes:

Rating of chillers	EN 12055
Construction of pressure vessel	TUV Standards (on request)
Electrical codes	IEC 204-1 CEI 44-5 Elect. & Safety Codes
Safety Codes	CEI-EN 60204–1 Codes
Manufacturing Quality Stds	ISO 9001:2000

REFRIGERANT

Will be accepted HFC 407C or equivalent refrigerant.

UNIT DESCRIPTION

Each chiller consist of multiple semi-hermetic rotary screw compressor, direct expansion avaporator, air-cooled condenser section, control system and all components necessary for safe and controlled unit operation.

NOISE LEVEL AND VIBRATIONS

Sound pressure level at 1 meter distance in free field, semispheric conditions, shall not exceeddBA. The sound pressure levels must be rated in accordance to ISO 3744. Other types of rating unacceptable. Vibration level should not exceed 2 mm/s.

DIMENSIONS

Unit length shall not exceed mm, unit width shall not exceed mm, unit height shall not exceed mm.

CHILLER COMPONENTS

Compressors

- ✓ The compressors shall be field serviceable, semi-hermetic, single-screw type with one main helical rotor meshing with two opposed gaterotor. Twin-screw compressor will no accepted because of the large bearing loads inherent with this design.
For a Single-screw compressor the two exactly opposed gaterotors create two exactly opposed compression cycles which results in balanced forces acting on the rotor compressor. The gaterotors will be constructed of a carbon impregnated engineered composite material. The gaterotor supports will be constructed of cast iron.
- ✓ The oil injection shall be used for these compressors in order to get high COP also at high condensing pressure and low sound pressure levels in each load condition.

- ✓ Refrigerant system differential pressure shall provide oil flow through service replaceable, 0.5 micron, full flow, cartridge type oil filter internal to compressor. Filter bypass or oil pump not acceptable.
- ✓ The compressor's oil cooling must be realized by liquid injection. External dedicated heat exchanger and additional piping to carry the oil from the compressor to heat exchanger and viceversa will be not accepted.
- ✓ The compressor shall be provided with a high efficiency, oil separator and with built-in oil filter.
- ✓ The compressor shall be direct electrical drive, without gear transmission between the screw and the electrical motor. The motor's compressor shall be designed for star/delta. Soft start should be available as option.
- ✓ The compressor casing shall be provided with ports to realize economized refrigerant cycles.
- ✓ Shall be present two thermal protection realized by a thermistor for high temperature protection to motor and a thermistor for discharge gas high temperature protection.
- ✓ The compressor shall be provided with an automatic spring return of capacity control valve to the minimum load position to ensure compressor starting always at minimum motor load so with the minimum mechanical stress.

Evaporator

- ✓ The units shall be supplied with shell and tubes counter-flow evaporator single refrigerant pass. It will be direct expansion with refrigerant inside the tubes and water outside (shell side) with carbon steel tube sheets, with straight copper tubes that are spirally wound internally for higher efficiencies, expanded on the tube plates.
- ✓ The external shell, shall be linked with an electrical heater to prevent freezing up to -28 C ambient temperature, commanded by a thermostat and shall be insulated with flexible, closed cell polyurethane insulation material.
- ✓ The evaporator will have 2 or 3 circuits, one for each compressor and shall be single refrigerant pass to ensure a simpler oil circulation so to ensure always a perfect oil return to the compressor.
- ✓ If a plate to plate heat exchanger is used, the manufacturer shall provide to furniture an adequate buffer tank to avoid frequently compressors star-stop and to allow a good evaporator leaving water temperature control. The manufacturer also shall provide to furniture a feed water line filter, a monitoring system of the refrigerant pressure drop inside the plate to plate heat exchanger and a system to protect the component from hydraulic pressure waves caused by water circulation pump stop.
- ✓ Evaporator is manufactured in accordance to PED approval.

Condenser coil

- ✓ The condenser coils are constructed with internally enhanced seamless copper tubes having a "W" configuration and arranged in a staggered row pattern and mechanically expanded into lanced and rippled aluminium fins with full fin collars for higher efficiencies. The space between the fins are given by a collar that will increase the surface area in connection with the tubes, protecting them from ambient corrosion.
- ✓ The coils will have an integral subcooler circuit which provides sufficient subcooling to effectively eliminate the possibility of liquid flashing and increase the unit's efficiency of 5-7% without an increase in power absorbed, and the surface area will be designed in order to have an air velocity not higher than 2.8 m/sec.

Condenser fans

- ✓ The fans used in conjunction with the condenser coils, shall be helical type with aerofoil blades for higher efficiencies and lower noise. Each fan shall be equipped with a heavy-gauge fan guard.
- ✓ The air discharge shall be vertical and each fan must be coupled to the electrical motor, supplied as standard to IP54 and capable to work to ambient temperatures of -40 C to +55 C. There is also an accident protection within the motors.

Refrigerant circuit

- ✓ The unit must have refrigerant circuits completely independent of each other with one compressor per circuit.
- ✓ Each circuit shall include an: electronic expansion valve, compressor discharge shut-off valve, a liquid line shut-off valve with charging connection, replaceable core filter-drier, sight glass with moisture indicator and insulated suction line. Suction line shut-off valve should be available as option.

Regulation of cooling capacity

- ✓ Each unit will have a microprocessor for the control of compressor slide valve's position (2 slide valves, one for each compressor's cycles).
- ✓ The slides shall have a stepless motion that allows a unit's operation with infinitely variable capacity control down to 12,5% (2 compressors) or down to 8,3% (3 compressors) of the cooling capacity. The chiller shall be capable of stable operation to a minimum of 12,5% (2 compressors) or 8,3% (3 compressors) of full load without hot gas bypass.
- ✓ Step unloading unacceptable because of evaporator leaving water temperature fluctuation and low compressor's efficiency at partial load.
- ✓ The system shall stage the unit based on the leaving water temperature.

Electronic expansion valve

- ✓ Electronic expansion valve allows a simple and perfect control system that quickly interacts at load variations. This valve combines two functions: liquid solenoid and electronic expansion valve.
- ✓ It is managed directly by a microprocessor to match exactly the plant thermal load.
- ✓ Thermostatic valve unacceptable because of its limited load range, higher refrigerant pressure drop and because of leaving evaporator water temperature control less good than an electronic device.

Condensation control

- ✓ The units will be provided with an automatic control for condensing pressure which ensures the working at low external temperatures down to +10 C, because of the ON/OFF of the condenser fans, to maintain condensing pressure. Fan speed control, to allow unit's operation with very low ambient temperature, should be available as option.

Control panel

- ✓ Field power connection, control interlock terminals, and unit control system should be centrally located in an electric panel (IP 54). Power and starting controls should be separate from safety and operating controls in different compartments of the same panel.
- ✓ Starting will be star/delta type as standard feature.
- ✓ Power and starting controls should include fuses and contactors for each compressor winding and fan motors. Operating and safety controls should include energy saving control; emergency stop switch; overload protection for compressor motor; high and low pressure cut-out switch (for each refrigerant circuit); anti-freeze thermostat; cut-out switch for each compressor.
- ✓ All of the information regarding the unit will be reported on a display and with the internal built-in calendar and clock that will switch the unit ON/OFF during day time all year long.
- ✓ The following features and functions shall be included:
 - resetting chilled water temperature by controlling the return water temperature or by a remote 4-20 mA DC signal or by controlling the external ambient temperature;
 - soft load function to prevent the system from operating at full load during the chilled fluid pulldown period;
 - password protection of critical parameters of control;
 - start-to-start and stop-to-start timers to provide minimum compressor off-time with maximum motor protection;
 - communication capability with a PC or remote monitoring;
 - discharge pressure control through intelligent cycling of condenser fans;
 - lead-lag selection by manual or automatically by circuit run hours;
 - double set point for brine unit version;
 - scheduling via internal time clock to allow programming of a yearly start-stop schedule accommodating weekends and holidays.

Display Capabilities

The controller as a minimum shall be capable of monitoring and displaying the following data:

<u>Analogue Inputs (AI)</u>	<u>Digital Inputs (DI)</u>
1 Entering Evaporator fluid Temp.	1 Control switch one per comp.
2 Leaving Evaporator fluid Temp.	2 Evaporator Fluid flow switch
3 Outside Air Temp.	3 Phase monitor
4 Not Used	4 Double Setpoint (Ice Mode)
5 Discharge Press., one per comp.	5 High Press. Switch, one per compressor
6 Discharge Press., one per comp.	6 High Press. Switch, one per compressor
7 Setpoint Override (Setpoint Reset)	7 Low Press. Switch, one per compressor
8 Demand Limit or Current Limit (Site Selectable)	8 Oil Press. Switch, one per compressor
9 % Capacity Signal, one per comp.	9 Transition Fault, one per compressor
10 % Capacity Signal, one per comp.	10 Discharge Temp. Switch, one per comp.
	11 External Alarm

Standard Customer Interfaces

The controller as a minimum shall be capable of providing the following interlocks: -

Chiller Enable Signal: Digital Input,
customer contact must be capable of handling 110 Volts, 50 HZ, 1 Amp.

Chiller Common Fault: Volt free, normally open, digital contact,
Must be capable of switching 250 V, 50 HZ, 1 Amp.

Pump Enable Signal:: Volt free, normally open, digital contact,
Must be capable of switching 250 V, 50 HZ, 1 Amp.

Setpoint Override:: 4 – 20 mA DC analogue input signal.

Demand Limit:: 4 – 20 mA DC analogue input signal.

Or

Current Limit:: 4 – 20 mA DC analogue input signal.

Optional Customer Interfaces

Compressor Running Signals: Volt free, normally open, digital contact,
Capable of switching 250 V, 50 HZ, 1 Amp.

Optional High Level Communications Interface

The controller as a minimum shall be capable of providing the data shown in the above list and document entitled McQuaycomms, using the following options: -

Option A RS485 Serial card

Option B RS232 Serial card

Option C LonWorks interface to FTT10A Transceiver.

Option D Bacnet Compatible

Option E Use of Compass Points (manufactured by North Communications) to allow communications with Such as Honeywell, Satchwell, Johnson Controls, Trend etc.

NOISE REDUCTION SOLUTIONS

- ✓ The unit compressors shall be mounted on a metal baseframe which shall be connected with unit's metal baseframe by rubber antivibration supports to prevent the transmission of vibrations to all metal unit structure and so to control the unit noise. (*for all Noise Versions*)
- ✓ The discharge compressor line shall be provided with a metal, flexible coupling between the discharge compressor valve and the air condensing section to eliminate vibration and so to reduce the noise unit emission. (*only for Noise Versions LN, XN and XXN*)
- ✓ The chiller shall be provided with an acoustically compressor enclosure. This enclosure shall be realized with an light, corrosion resisting aluminium structure and metal panels. The compressors sound-proof enclosure shall be internally fitted with flexible, multi layer, high density materials. The middle layer is 3 mm, very high density and high efficiency noise reduction material. The enclosure shall be carefully assembled to avoid decreasing of its noise reduction power. (*only for Noise Versions CN, XN and XXN*)
- ✓ The chiller shall be provided with very low speed condenser fans and with a larger condenser section.

We reserve the right to make changes in design and construction at any time without notice, thus the cover picture is not binding.

McQuay partecipa al programma di
Certificazione Eurovent.
I prodotti interessati figurano nella Guida
Eurovent dei Prodotti Certificati.



McQuay is participating in the Eurovent
Certification Programme
Product are as listed in the Eurovent
Directory of Certified Products

McQuay
International

McQuay Italia S.P.A.

S.S. Nettunense, km 12+300 – 00040 Cecchina (Roma) Italia – Tel. (06) 937311 – Fax (06) 9374014 – Email: info@mcquayeuropa.com
www.mcquayeuropa.com