

GRUNDFOS INSTRUCTIONS

Hydro Multi-E

CME

 GRUNDFOS
PRESSURE BOOSTING

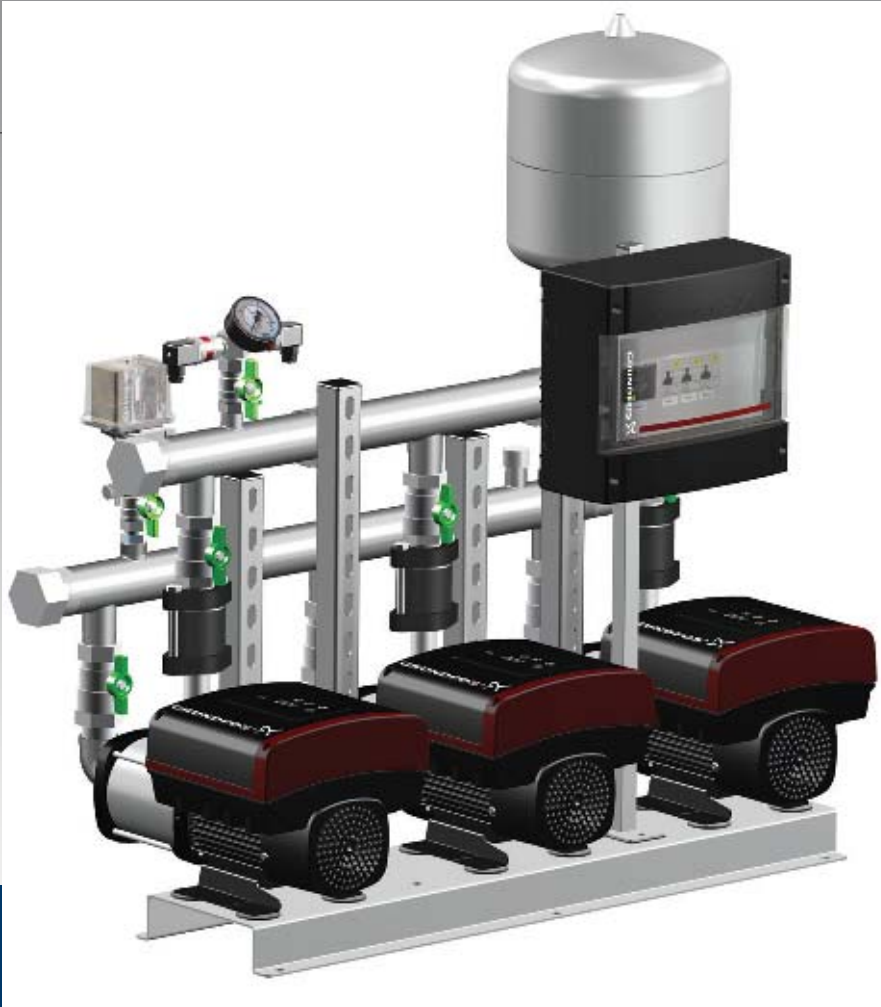

be think innovate

GRUNDFOS 



1



2

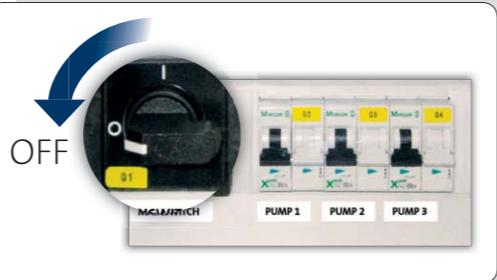

3

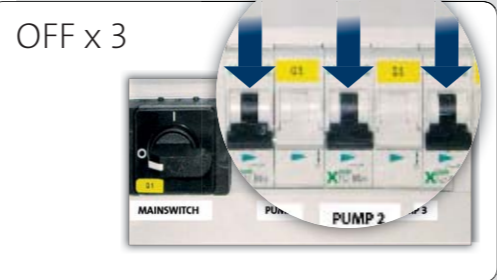

4

Factory settings	
Date	Setting (SP)

Customer settings		
Date	Setting (SP)	Initials



P = 0.7 x **SP** ✓

P = 0 bar



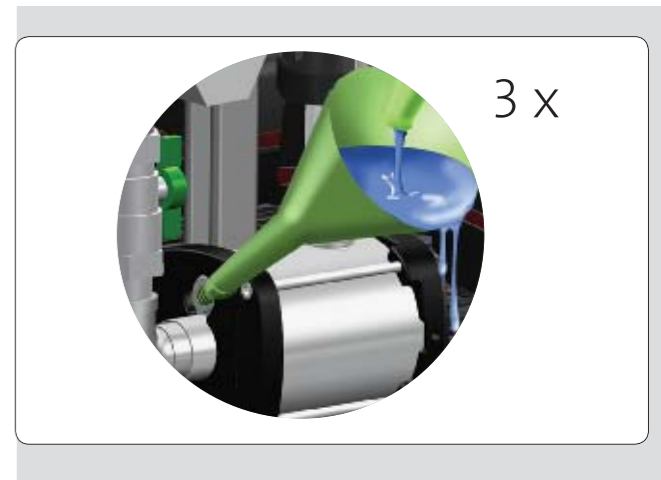
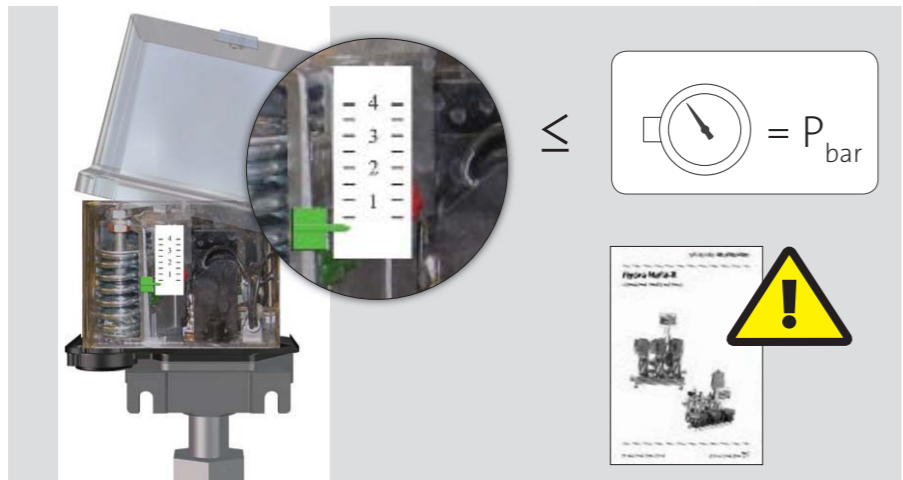
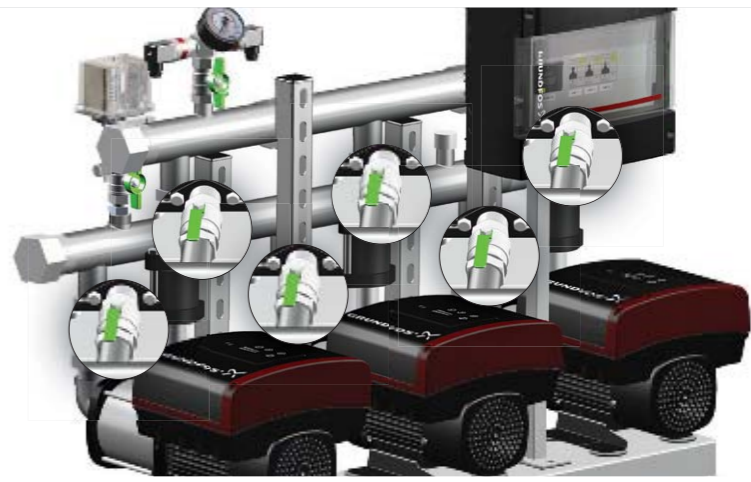
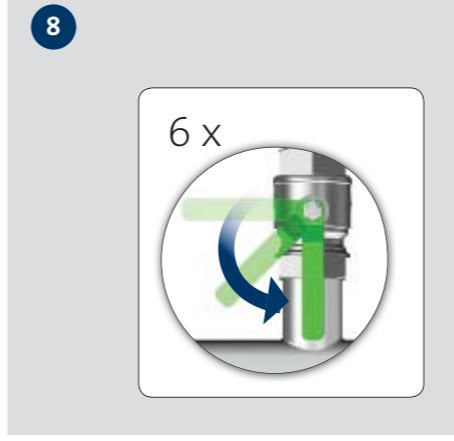
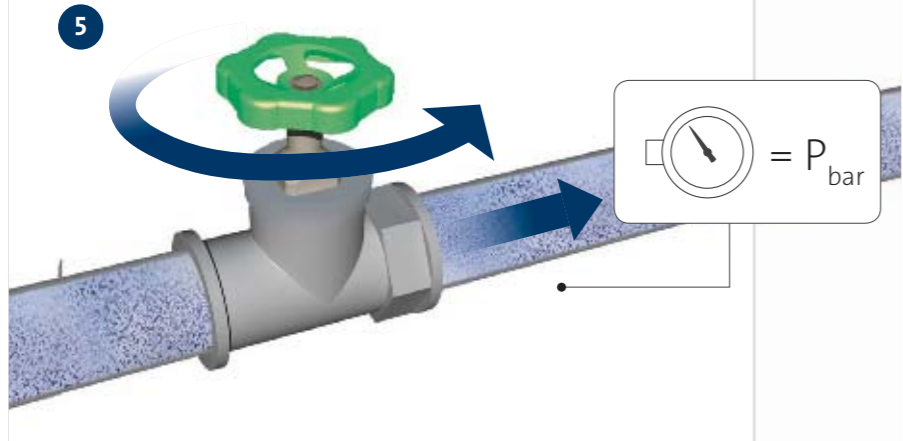

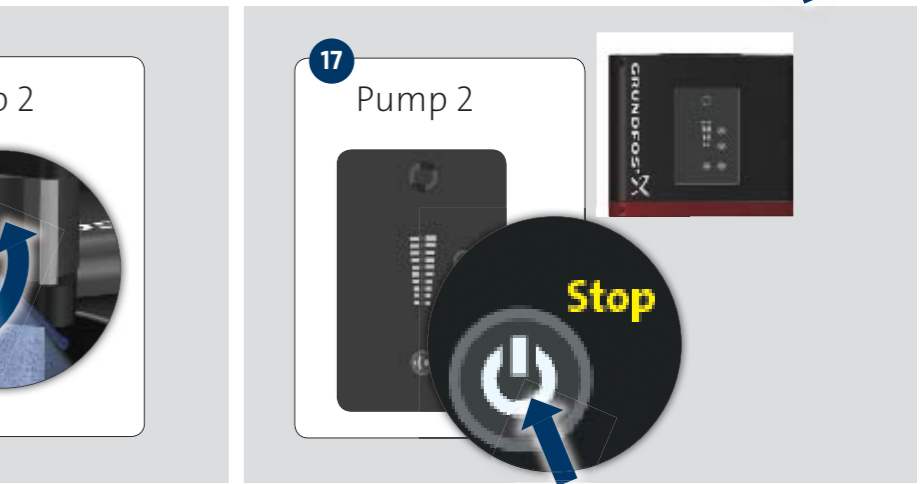
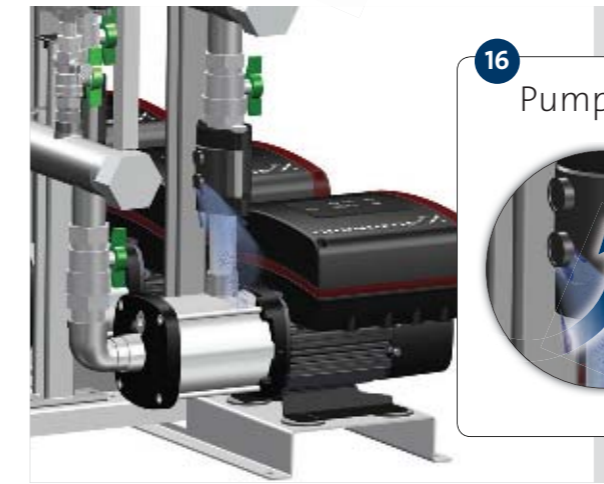
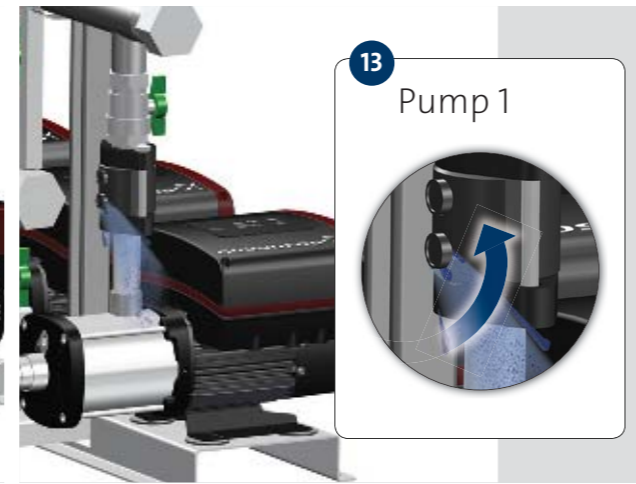
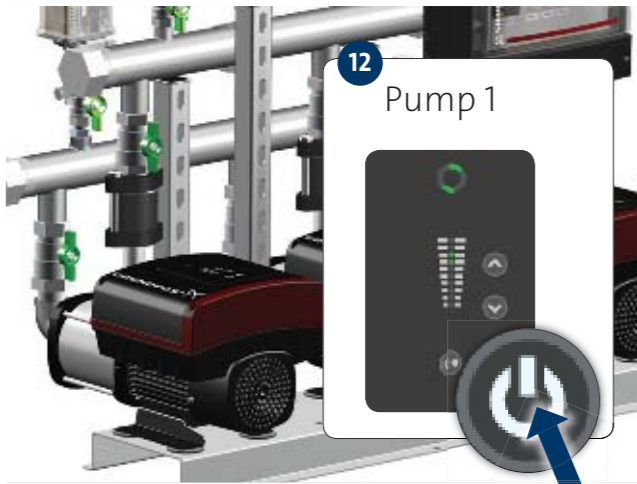
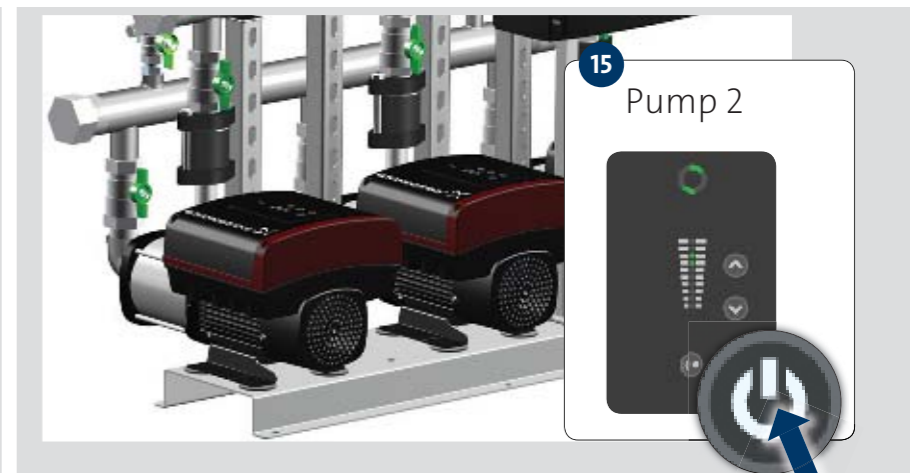
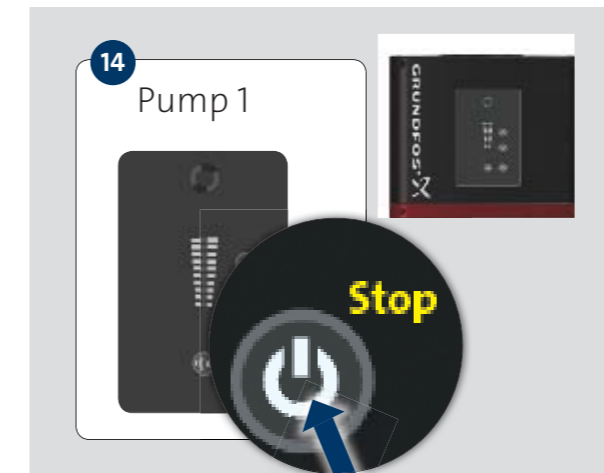
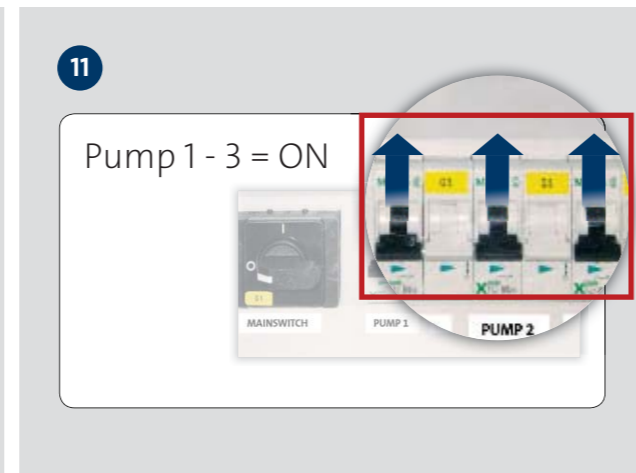

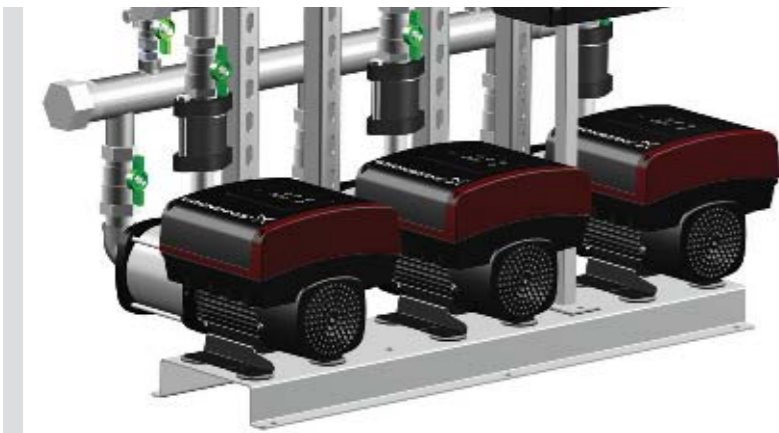

18

Pump 3

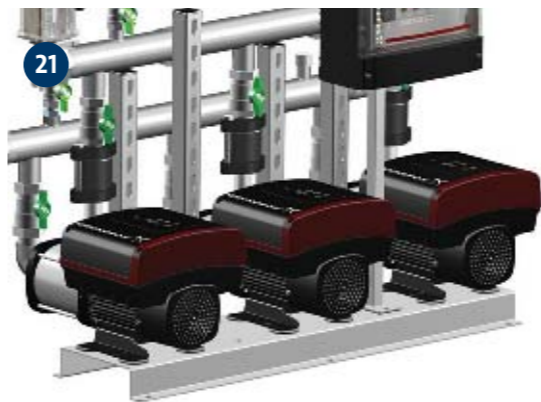

21

Pump 1



Pump 2



Pump 3



19

Pump 3

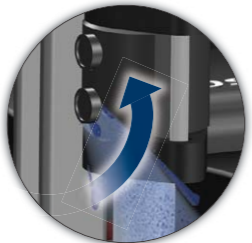

20

Pump 3

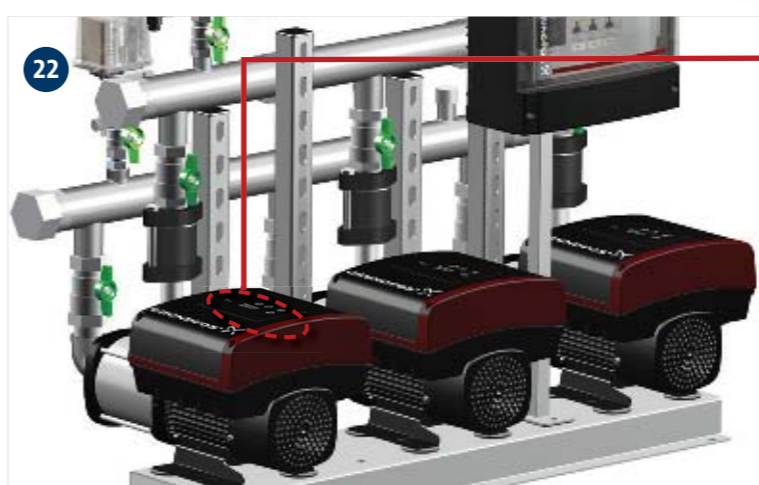
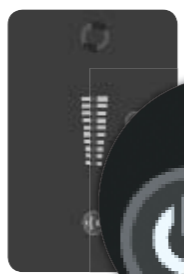

22

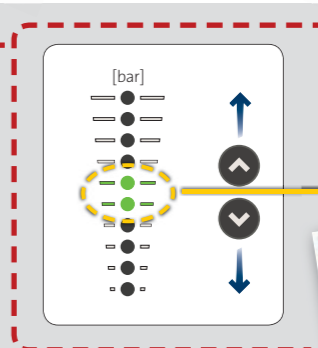

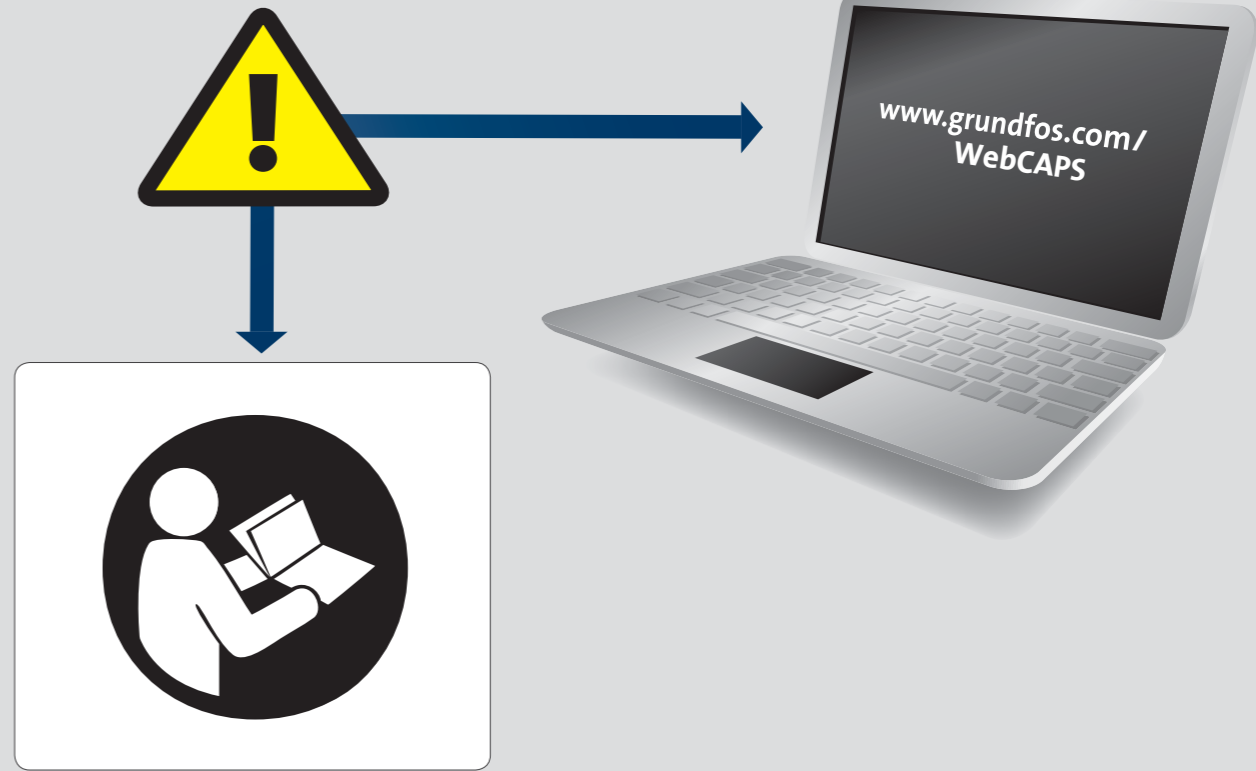

98477597 0813

ECM: 1117626

be think innovate

GRUNDFOS 

The name Grundfos, the Grundfos logo, and the payoff be think innovate are registered trademarks owned by Grundfos Holding A/S or Grundfos A/S, Denmark. All rights reserved worldwide.