

## CLIMATIC (V 1.0) USER MANUAL

# LIQUID CHILLER

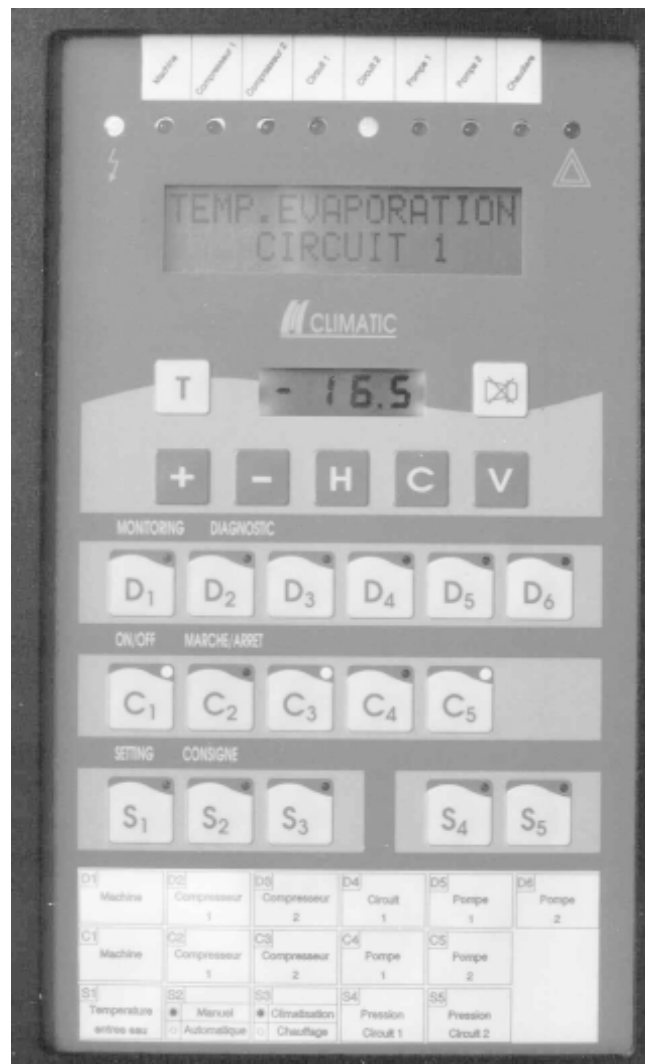

# GENERAL CONTROL OF LIQUID CHILLERS

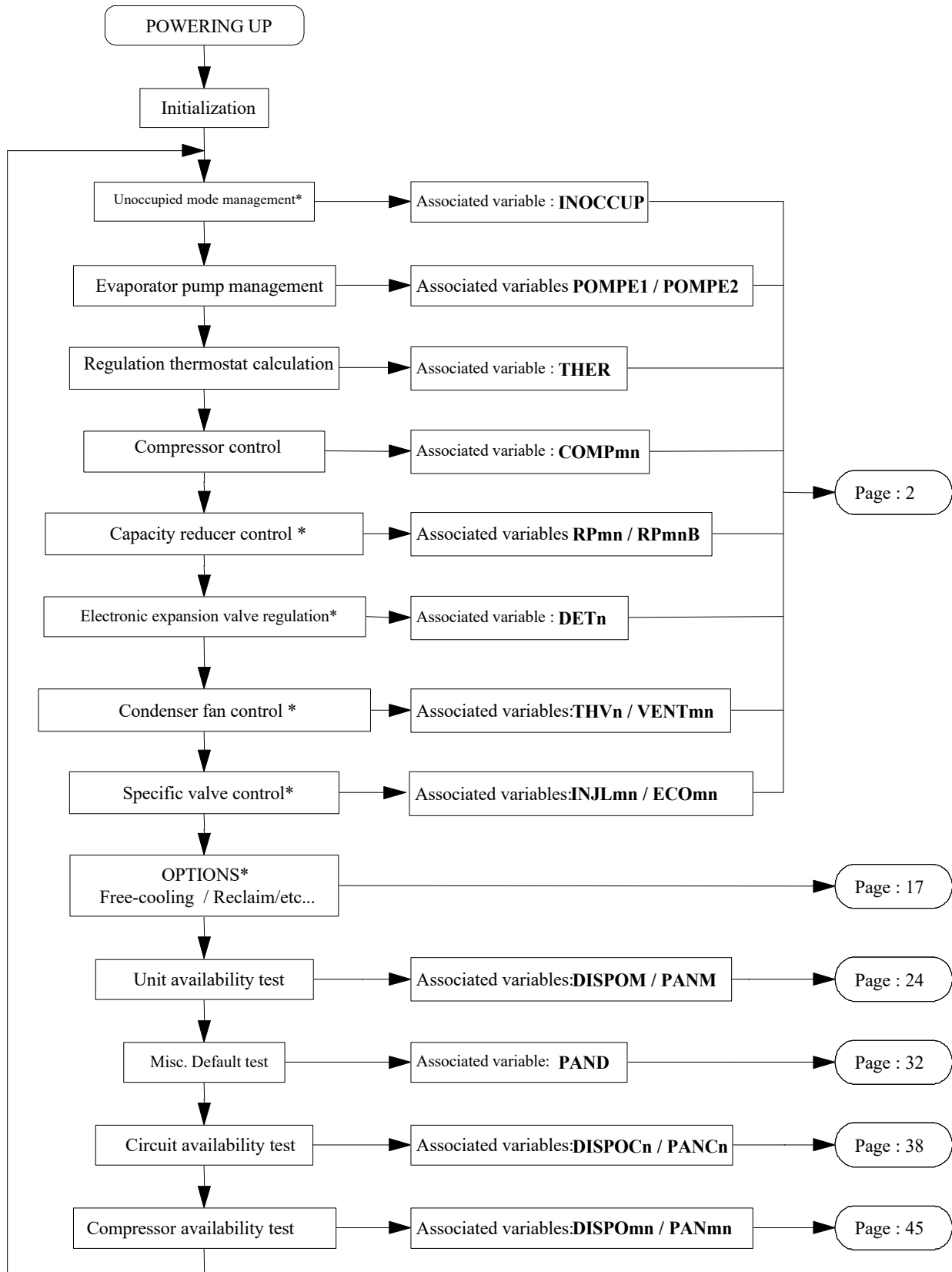

\* Only if the unit is so equipped

# COMMAND AND CONTROL

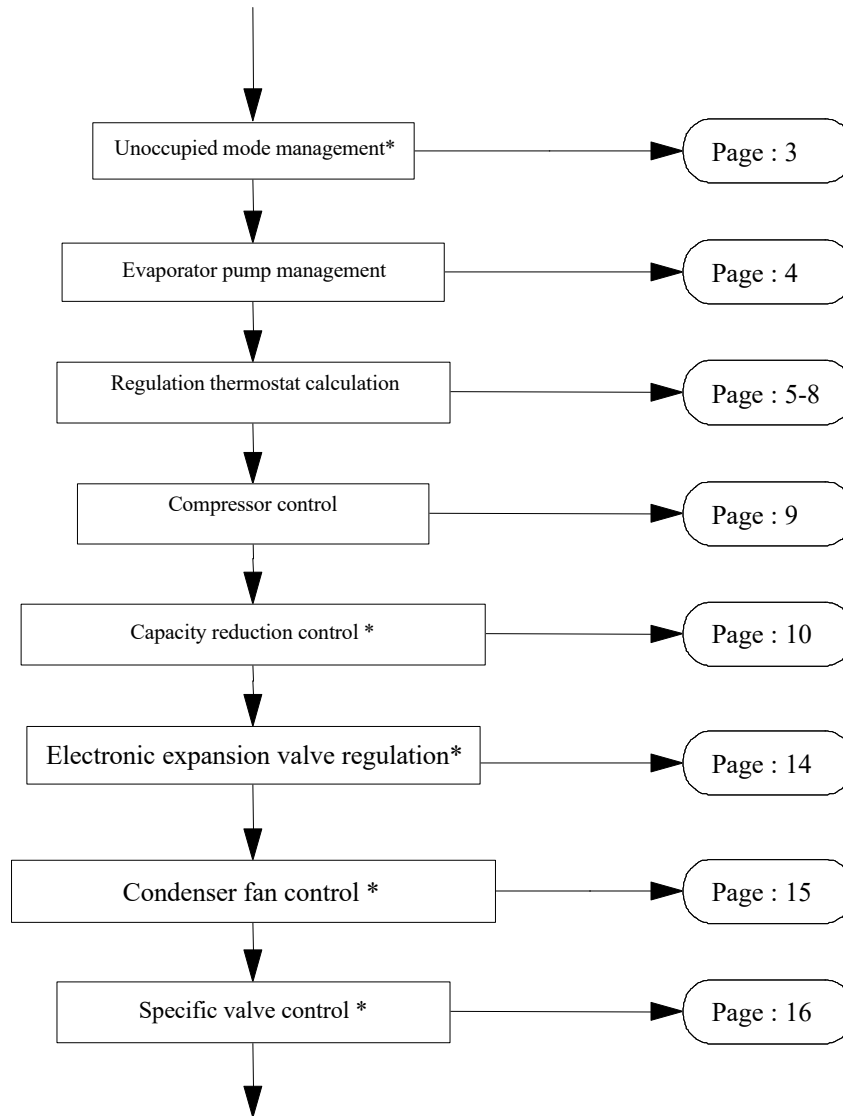

\* Only if the unit is so equipped

# UNOCCUPIED MODE FUNCTION

## Function

The unoccupied mode function enables the unit to be shut down during certain hours in the day or certain days of the week. Outside the unoccupied period, the chiller generally controls according to its setpoint.

## Description

The unoccupied mode function is defined by 4 setpoints:

- HDEBUTI ⇨ daily unoccupied mode start-time
- HFINI ⇨ daily unoccupied mode end-time
- JDEBUTI ⇨ weekly unoccupied mode start-day
- JFINI ⇨ weekly unoccupied mode end-day

The JDEBUTI and HDEBUTI terminals are included in the unoccupied period.  
By convention, Sunday is the first day of the week.

Optionally, the customer can remote-validate or remote-disable the unoccupied mode function through means of a potential free contact to be connected to an input on the 24EL board (see wiring diagram). The variable associated with this input is MAARI.

- MAARI = 0 ⇨ the unoccupied mode clocks are ignored.
- MAARI = 1 ⇨ the unoccupied mode clocks are managed.

### Example:

One wants to stop the unit:

- from Monday to Friday from 7 p.m. until the following morning at 6 a.m.
- on Saturday and Sunday, throughout the day.

☞ In this case, the setpoints should be adjusted as follows :

HDEBUTI	=	19
HFINI	=	6
JDEBUTI	=	7
JFINI	=	2

# EVAPORATOR PUMP MANAGEMENT

## Function

To ensure the flow of coolant in the evaporator.

## Description

Two types of control can be carried out. They are defined by the DEUXPOMPE variable.

❶ DEUXPOMPE = 1 ⇔ the CLIMATIC manages two pumps in normal backup mode.

❷ DEUXPOMPE = 0 ⇔ the CLIMATIC manages one pump or none.

The customer must configure the DEUXPOMPE parameter by shunting or by leaving the corresponding 24EL board input open (see the wiring diagram for location of the shunt).

### Case n°1:

☞ The POMPEk pump is in service if all the following conditions are satisfied:

⇒ At least one circuit n On / Off is ON (MAARn = 1).

⇒ The unit remote On / Off is ON (MAARD = 1).

⇒ Unit is not in a unoccupied period (INOCUP = 0).

⇒ The POMPEk pump has priority (PRIP = k-1).

⇒ The pump has been idle for 1 minute or it is already running.

⇒ There are no power defaults on the pump (ELECPk = 1).

⇒ There are no flow defaults on the pump (SDEBk = 0).

Outdoors air temperature < 2°C  
(Freezing-free pump reset option)

The pump priority changes automatically **once a week on Monday at 6 p.m.**

Should a default occur on the pump in service, the control switches automatically to the second pump if the latter is available.

### Case n°2:

☞ POMPE1 pump is in service if:

⇒ At least one circuit n On / Off is ON (MAARn = 1).

⇒ The unit remote On / Off is ON (MAARD = 1).

⇒ The unit is not in an unoccupied period (INOCUP = 0).

⇒ The pump has been idle for 1 minute or it is already running.

⇒ There are no power defaults on the pump (ELECP1 = 1).

⇒ There are no flow defaults on the pump (SDEB1 = 0).

Outdoors air temperature < 2°C  
(Freezing-free pump reset option)

POMPE1 is always managed by the CLIMATIC even if, electrically, the installation pump is not controlled by the refrigerating unit.

Should the customer manage his pump, he must comply with the following procedures:

● The pump must be started up 1 minute before validating the unit's remote On / Off.

● The pump must be stopped at least 2 minutes after the remote On / Off has switched to OFF.

**Comment:** in order to avoid any risk of the evaporator freezing up, the CLIMATIC stops the pumps only 2 minutes after a request for intentional stoppage of the machine or circuits.

# COLD THERMOSTAT

## Function

To adjust the temperature of the cooled fluid as close as possible to the setpoint, by adapting the number of compressors in service to the use heat load.

## Description

The thermostat controls the start-ups and shutdowns of the compressors. It is calculated according to the chilled water inlet temperature as follows:

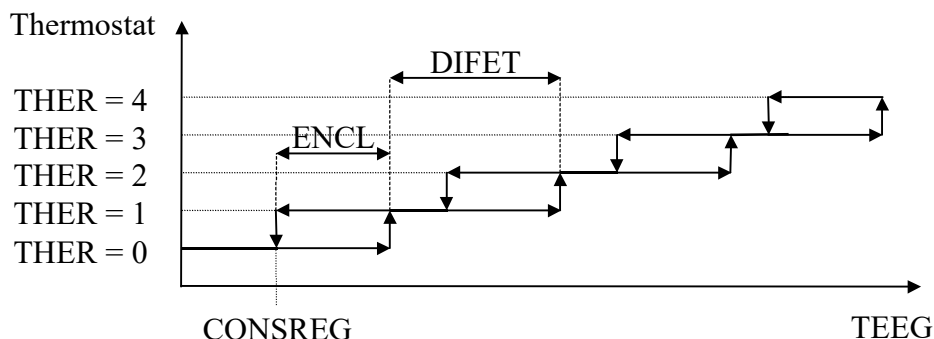

### ☞ Definition of various parameters:

- ENCL           ⇒ Operating differential of a stage (°K)
- DIFET         ⇒ Differential between stages (°K)
- THER          ⇒ Thermostat
- TEEG          ⇒ Chilled water inlet temperature
- CONSREG      ⇒ CLIMATIC control water outlet setpoint (°C)  
This is equal to CONSEA or CONSEB, depending on the state of an input on the 24EL card with which the CHPCONS variable is associated  
CHPCONS = 0 ⇒ CONSREG = CONSEA.  
CHPCONS = 1 ⇒ CONSREG = CONSEB.  
In case of control with PENTE, see control section with cooling load ramp.

### ☞ Example of control:

CONSREG = 6°C  
ENCL = 1,5°C  
DIFET = 1,5°C

THER	Cut-in	THER	Cut-out
000 ⇒ 001	7,5°C	001 ⇒ 000	6°C
001 ⇒ 002	9°C	002 ⇒ 001	7,5°C
002 ⇒ 003	10,5°C	003 ⇒ 002	9°C
003 ⇒ 004	12°C	004 ⇒ 003	10,5°C

**Comment :** The thermostat is authorized to increment by one stage only if the following conditions are satisfied:

- ⇒ THER has not been increased for at least **3 minutes**
- ⇒ the chilled water outlet temperature is higher than the setpoint
- ⇒ the number of compressors in service is equal to the thermostat value.

## Method for determining ENCL and DIFET

$$DIFET = \frac{DT}{\text{Num.ofCompressors}}$$

DIFET is rounded down to the next half-degree.

$$ENCL = DT - (DIFET \cdot (\text{Num.ofCompressors}))$$

with  $\Delta T = TEEG - TSEG$ .

# HEAT THERMOSTAT

## Function

To adjust the temperature of the heated fluid as close as possible to the setpoint, by adapting the number of compressors in service to the use heat load.

## Description

The thermostat controls the start-ups and shutdowns of the compressors. It is calculated according to the hot water inlet temperature as follows:

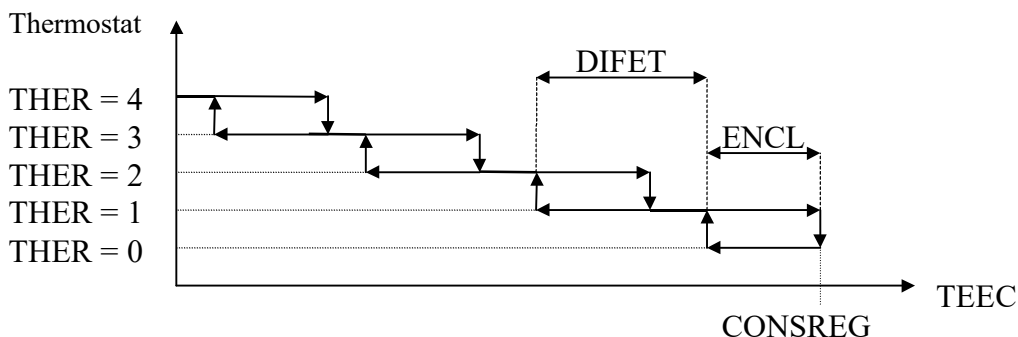

### ☞ Definition of various parameters:

ENCL           ⇒ Operating differential of a stage (°K)

DIFET           ⇒ Differential between stages (°K)

THER           ⇒ Thermostat

TEEC           ⇒ Hot water inlet temperature

CONSREG       ⇒ CLIMATIC control water outlet setpoint (°C)

This is equal to CONSEA or CONSEB depending on the state of an input on the 24 EL card with which the CHPCONS variable is associated.

CHPCONS = 0 ⇒ CONSREG = CONSEA.

CHPCONS = 1 ⇒ CONSREG = CONSEB.

In case of control with PENTE, see control section with cooling load ramp.

### ☞ Example of control :

CONSREG       = 45°C  
ENCL            = 1,5°C  
DIFET           = 1,5°C

THER	Cut-in	THER	Cut-out
000 ⇔ 001	43,5°C	001 ⇔ 000	45°C
001 ⇔ 002	42°C	002 ⇔ 001	43,5°C
002 ⇔ 003	40,5°C	003 ⇔ 002	42°C
003 ⇔ 004	39°C	004 ⇔ 003	40,5°C

**Comment:** The thermostat is authorized to increment by one stage only if the following conditions are satisfied:

- ⇒ THER has not been increased for at least **3 minutes**
- ⇒ the hot water outlet temperature is lower than the setpoint
- ⇒ the number of compressors in service is equal to the thermostat value.

## Method for determining ENCL and DIFET

$$\text{DIFET} = \frac{\text{DT}}{\text{Num. of Compressors}}$$

DIFET is rounded down to the next half-degree.

$$\text{ENCL} = \text{DT} - (\text{DIFET} \cdot (\text{Num. of Compressors}))$$

with  $\Delta T = \text{TSEC} - \text{TEEC}$ .

# CONTROL WITH COOLING LOAD RAMP

## Function

To adapt the control setpoint to the outdoor air temperature, in order to combat heat leakage more efficiently between the area to be cooled and outside ambient conditions.

## Description

Calculation of the CONSREG control setpoint is carried out as follows:

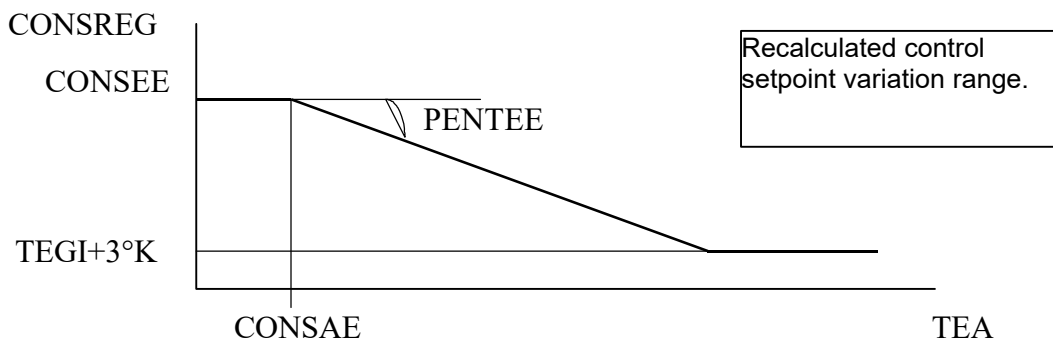

### ☞ Definition of various parameters:

- CONSREG ⇒ Control water setpoint calculated by the CLIMATIC (°C)
- CONSEE ⇒ Maximum water setpoint authorized at evaporator inlet (°C)
- CONSAE ⇒ Beginning of ramp setpoint for start of CONSREG calculation (°C)
- PENTEE ⇒ Control ramp setpoint (%)
- TEGI ⇒ Minimum water setpoint at evaporator (°C)
- TEA ⇒ Outside air temperature (°C)

### ☞ Example of control:

- CONSEE = 15°C
- CONSAE = 20°C
- PENTEE = 50%

TEA	CONSREG
20°C	15°C
25°C	12,5°C
30°C	10°C
35°C	7,5°C

## Method for determining PENTEE AND CONSREG

$$\text{CONSREG} = \text{CONSEE} - \left( \frac{(\text{TEA} - \text{CONSAE})}{100} \times \text{PENTEE} \right)$$

$$\text{PENTEE} = (\text{CONSEE} - \text{CONSREG}) \times \left( \frac{100}{(\text{TEA} - \text{CONSAE})} \right)$$



# CONTROL WITH HEATING LOAD RAMP

## Function

To adapt the control setpoint to the outdoor air temperature in order to combat the heat leakage more efficiently between the area to be heated and outside ambient conditions.

## Description

Calculation of the CONSREG control setpoint is carried out as follows:

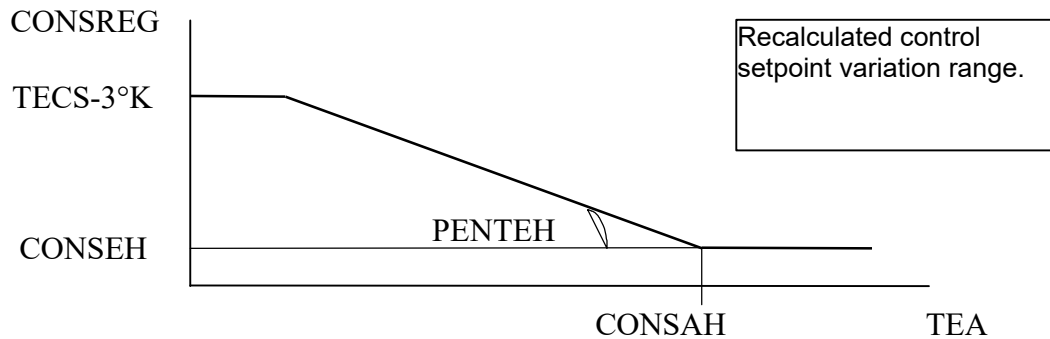

### ☞ Definition of various parameters:

- CONSREG ⇒ Control water setpoint calculated by the CLIMATIC (°C)
- CONSEH ⇒ Minimum water setpoint authorized at condenser inlet (°C)
- CONSAH ⇒ Beginning of ramp setpoint for start of CONSREG calculation (°C)
- PENTEK ⇒ Control ramp setpoint (%)
- TECS ⇒ Maximum water setpoint at condenser (°C)
- TEA ⇒ Outside air temperature (°C)

### ☞ Example of control :

- CONSEH = 35°C
- CONSAH = 18°C
- PENTEK = 50%

TEA	CONSREG	TEA	CONSREG
18C	35°C	0	44°C
15°C	36,5°C	-5	46,5°C
10°C	39°C	-10	49°C
5°C	41,5°C	-15	51,5°C

## Method for determining PENTEK AND CONSREG

$$\text{CONSREG} = \text{CONSEH} + \left( \frac{(\text{CONSAH} - \text{TEA})}{100} \times \text{PENTEK} \right)$$

$$\text{PENTEK} = (\text{CONSREG} - \text{CONSEH}) \times \left( \frac{100}{(\text{CONSAH} - \text{TEA})} \right)$$

# COMPRESSOR CONTROL

## Function

The compressors are started up and stopped in an order which takes account of the the anti-short cycle time delays and equalizes their operating times.

## Description

### ☞ Compressor start up and shutdown order

This order is determined by a "FIFO" law (first in, first out ⇒ first one started up, first one shut down). This function integrates an automatic mode in case of unavailability of a priority compressor. This avoids waiting until the thermostat demands an additional stage before the backup compressor starts up.

### ☞ Example of control with 4 compressors:

<b>Value of THER thermostat</b>	0	1	2	3	4	3	4	3	2	1	2	3	2	3	4	3	2	1	0
<b>Number of compressors to start up</b>	-	1	2	3	4	-	1	-	-	-	2	3	-	4	1	-	-	-	-
<b>Number of compressors to shut down</b>	-	-	-	-	-	1	-	2	3	4	-	-	1	-	-	2	3	4	1
<b>Numbers of compressors which are to operate</b>	-	1	1 2	1 2 3	1 2 3 4	2 3 4	2 3 4 1	3 4 1	4 1	1	1 2	1 2 3	2 3	2 3 4	2 3 4 1	3 4 1	4 1	1	-

### ☞ Compressor start up and shutdown

The COMPmn compressor starts up if all the following conditions are satisfied:

- ⇒ The evaporator pump has been running for at least 1 minute.
- ⇒ Circuit n On / Off is ON (MAARn = 1).
- ⇒ The machine is available (DISPOM = 1).
- ⇒ Circuit n is available (DISPOCn = 1).
- ⇒ Compressor mn is available (DISPOmn = 1).
- ⇒ The THER control thermostat is greater than the number of compressors in service.
- ⇒ COMPmn is the compressor that the FIFO law defines as being the next one which is to start up.
- ⇒ COMPmn is not in anti-short cycle (ACCmn = 1).

The COMPmn compressor stops if at least one of the following conditions is validated:

- ⇒ The machine remote On / Off is OFF (MAARD = 0).
- ⇒ The circuit n On / Off is OFF (MAARn = 0).
- ⇒ The machine is unavailable (DISPOM = 0).
- ⇒ Circuit n is unavailable (DISPOCn = 0).
- ⇒ Compressor mn is unavailable (DISPOmn = 0).
- ⇒ The THER control thermostat is less than the number of compressors in service and COMPmn is the compressor that the FIFO law defines as being the next one which is to stop.

# CAPACITY REDUCTION CONTROL

## Function

To adjust the water outlet temperature as close as possible to the setpoint by adapting the compressor capacity.

## Description

### ① Machines equipped with reciprocating semi-hermetic compressor units

#### a - Control on cold

The number of compressors which must operate in capacity reduction is defined by the THERR thermostat. This is calculated as follows:

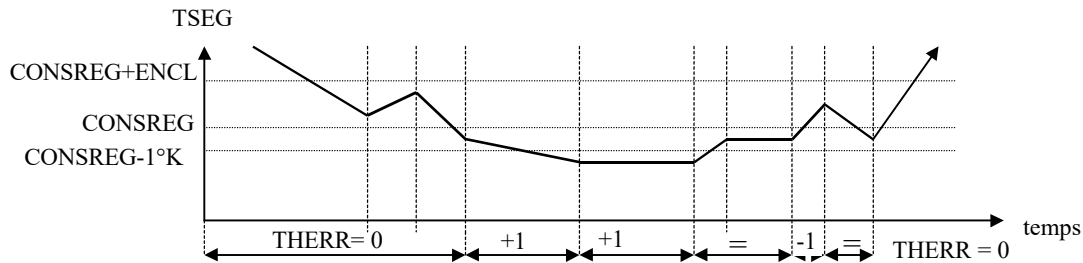

Description of the different parameters :

CONSREG ⇒ Control set point

THERR ⇒ Capacity reduction thermostat

TSEG ⇒ Chilled water outlet temperature

ENCL ⇒ Differential of capacity step operation

☞ As soon as TSEG is less than the control setpoint minus 1°C, a capacity reduction is activated. As long as the condition on TSEG is confirmed, an additional capacity reduction is activated (if there is one) every 6 minutes.

☞ As soon as TSEG is greater than the control setpoint, a capacity reduction is cut out. As long as the condition on TSEG is confirmed, a capacity reduction stage is deactivated every 6 minutes.

☞ As soon as TSEG is greater than the control setpoint plus one cut-in (ENCL), all the capacity reductions are deactivated.

#### b - Control on heat

The number of compressors which must operate in capacity reduction is defined by the THERR thermostat. This is calculated as follows :

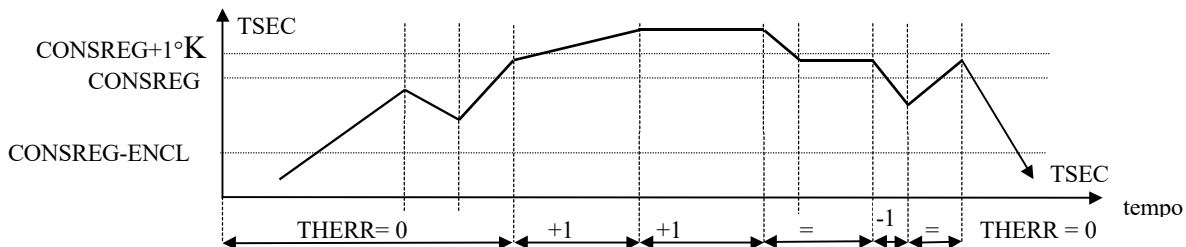

Description of the different parameters :

CONSREG ⇒ Control set point

THERR ⇒ Capacity reduction thermostat

TSEC ⇒ Hot water outlet temperature

ENCL ⇒ Differential of capacity step operation

# CAPACITY REDUCTION CONTROL (CONT.)

- ☞ As soon as TSEC is greater than the control setpoint plus 1°C, a capacity reduction is supplied. As long as the condition on TSEC is confirmed, an additional capacity reduction stage is activated (if there is one) every 6 minutes.
- ☞ As soon as TSEC is less than the control setpoint, a capacity reduction stage is deactivated. As long as the condition on TSEC is confirmed, one capacity reduction stage is deactivated every 6 minutes.
- ☞ As soon as TSEC is less than the control setpoint minus one cut-in (ENCL), all the capacity reductions are deactivated.

## ② Machines equipped with screw compressors (except MODUVIS)

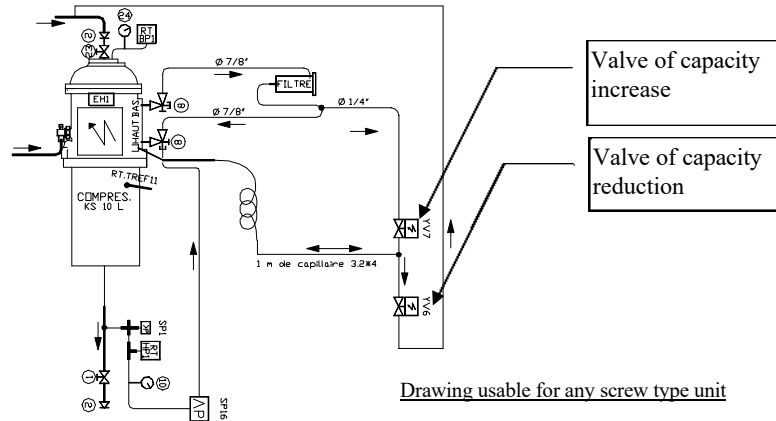

### a - Control principle

The compressor capacity reduction is controlled by an Proportional Integral Control law.

#### ☞ Proportional function

The more the difference in absolute value between the chilled water outlet temperature and the setpoint increases, the greater the amplitude of the action on the capacity control spool. (Raising or lowering of the spool according to the temperature difference sign)

The proportional law can be adjusted via setpoint KPRP (magnitude of action). The higher KPRP is, the greater the action on the spool.

#### ☞ Integral function

The more quickly the difference in absolute value between the chilled water outlet temperature and the setpoint increases, the more frequent are the actions on the capacity control spool.

The integral law can be adjusted via setpoint TIRP (frequency of action). The higher TIRP is, the shorter the time between two actions.

**Comment:** In order to avoid risks of instability, it is recommended that KPRP and TIRP not be increased at the same time.

## **b - Action on the spool's control solenoid valves**

The **RPmn** actuator enables selection of the solenoid valve for raising or lowering the spool.

### ☞ Control on cold

If TSEG is greater than the control setpoint:

RPmn = 0 ⇔ capacity increase position.

If TSEG is less than the control setpoint:

RPmn = 1 ⇔ capacity reduction position.

### ☞ Control on heat

If TSEC is less than the control setpoint:

RPmn = 0 ⇔ capacity increase position.

If TSEC is greater than the control setpoint:

RPmn = 1 ⇔ capacity reduction position.

The **RPmnB** actuator controls the supply of the capacity control valves according to the PI control.

If RPmnB = 0, no valve is supplied.

If RPmnB = 1, the valve selected by RPmn is supplied.

## **Comments:**

At start up, all semi-hermetic compressors (screw or reciprocating type) are maintained in capacity reduction for 1 minute.

On a machine including several screw compressors and a single heat-exchanger, capacity control is authorized for only a single compressor at a time.

## **⊕ MODUVIS**

MODUVIS units are equipped with one plate-type evaporator per circuit. Each compressor modulates its capacity according to the water outlet temperature of its TSEGN circuit. It is therefore possible for several compressors to be in capacity control at the same time on the same machine.

The **RPmn** actuator enables the capacity control spool to be raised or lowered.

### ☞ Control on cold

If TSEGN remains lower than the control setpoint for more than 14 seconds:

RPmn = 1 ⇔ capacity reduction position.

If TSEGN is greater than the control setpoint for more than 14 seconds:

RPmn = 0 ⇔ capacity increase position.

# CAPACITY REDUCTION CONTROL (CONT.)

## ☞ Control on heat

If TSECn remains greater than the control setpoint for more than 14 seconds:

RPmn = 1 ⇔ capacity reduction position.

If TSECn is less than the control setpoint for more than 14 seconds:

RPmn = 0 ⇔ capacity increase position.

The **RPmnB** actuator controls the supply of the valve selected by RPmn.

RPmnB = 1 . as soon as RPmn = 1 for at least 10 seconds  
                  . and as long as RPmn = 1  
or  
                  . as soon as RPmn = 0 for at least 10 seconds  
                  . and as long as RPmn = 0

⇔ the valve selected  
by RPmn is supplied.

In other cases, RPmnB = 0

⇔ no valve is supplied.

## **Comment:**

At start up, the compressors are maintained in capacity reduction for 1 minute.

## **Wiring diagram for capacity reduction control of screw compressors.**

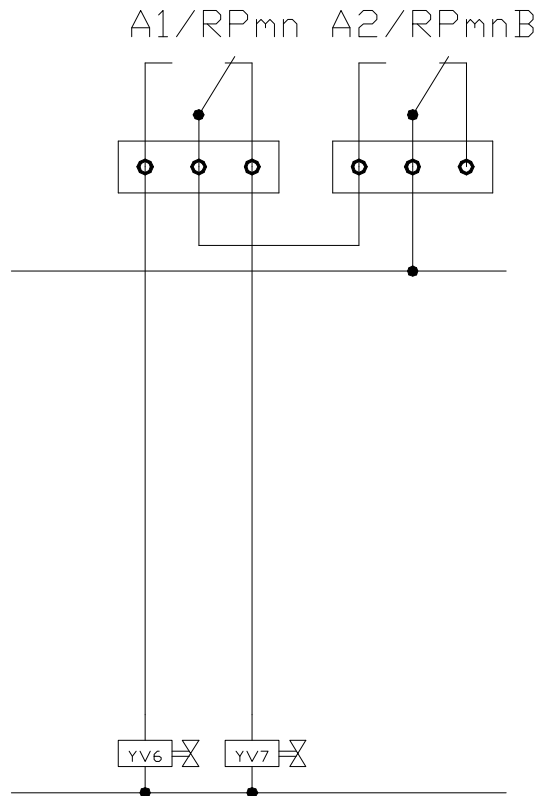

# ELECTRONIC EXPANSION VALVE CONTROL

## Function

To control the proper filling of refrigerant in the evaporator in order to obtain its best efficiency, whilst protecting the compressor from slugging.

## Description

The expansion valve is controlled by an Proportional Integral Control law. This PI law culminates in the calculation of the RDETA<sub>n</sub> ideal theoretical opening of the circuit n expansion valve.

### ☞ Proportional function

The more the difference between the measured superheat and the SURCHD superheat setpoint increases, the higher the added or subtracted value (depending on the sign of the difference) at RDETA<sub>n</sub>.

The proportional law can be adjusted via setpoint KP (magnitude of action). The higher KP is, the greater the amplitude of the action.

### ☞ Integral function

The more quickly the difference between the measured superheat and the setpoint increases, the more frequently RDETA<sub>n</sub> is increased or decreased.

The integral law can be adjusted via setpoint TI (frequency of action). The greater TI is, the shorter the time between two successive actions on RDETA<sub>n</sub>.

**Comment:** In order to avoid risks of instability, it is recommended that KP and TI not be increased at the same time.

When RDETA<sub>n</sub> is calculated, its value is compared to that of the opening of the RDETA<sub>n</sub> measured expansion valve:

- ⇒ If RDETA<sub>n</sub> > RDETA<sub>n</sub>, the expansion valve must be heated (DETA<sub>n</sub>=1) so that it opens to the required opening.
- ⇒ If RDETA<sub>n</sub> < RDETA<sub>n</sub>, the expansion valve is not heated (DETA<sub>n</sub>=0) so that it closes.
- ⇒ If RDETA<sub>n</sub> = RDETA<sub>n</sub>, the expansion valve is maintained at its present opening value through means of alternating start ups and stoppages of the heating.

Before the start up of the first compressor in the circuit, the expansion valve opening is calculated depending on the low pressure in the circuit, enabling any risk of slugging when the compressor starts up to be avoided.

# CONDENSER FAN CONTROL

## Function

To maintain a condensation pressure as stable as possible without the fans cycling too often.

## Description

The CLIMATIC calculates the number of THVn ventilation stages necessary for the proper operation of each refrigerating circuit.

THVn depends on the following parameters:

- ⇒ the condensation pressure of the PTHPn circuit n read by the sensor in bars
- ⇒ the TEA outdoor air temperature
- ⇒ the time

- ⇒ and three setpoints
 

HPHAUT	: high pressure limit (absolute bars)
HPBAS	: low pressure limit (absolute bars)
TEMPOV	: time-delay for raising or lowering of one ventilation stage (1U= 1 second).

(HPHAUT-HPBAS=5 bars minimum)

### ☞ Starting up the fans

At start up of the first compressor in the circuit, as soon as the high pressure becomes greater than HPBAS+1 bar, activates a number of fans N. N depends on the outdoor air temperature.

If PTHPn exceeds HPHAUT, the thermostat is increased by one stage. If the pressure stays above HPHAUT, THVn continues to be increased by one unit every time:

- ⇒ TEMPOV if  $HPHAUT < PTHPn = HPHAUT + 1\text{bar}$
  - ⇒ TEMPOV/2 if  $HPHAUT + 1\text{bar} < PTHPn = HPHAUT + 2\text{bars}$
  - ⇒ TEMPOV/4 if  $PTHPn > HPHAUT + 2\text{bars}$ .
- Fan m in circuit n operates (VENTmn = 1) if  $THVn \geq m$ .

### ☞ Stopping the fans

As soon as PTHPn becomes lower than HPBAS, THVn is reduced by one stage. As long as PTHPn stays below HPBAS, THVn continues to be decremented by 1 every TEMPOV.

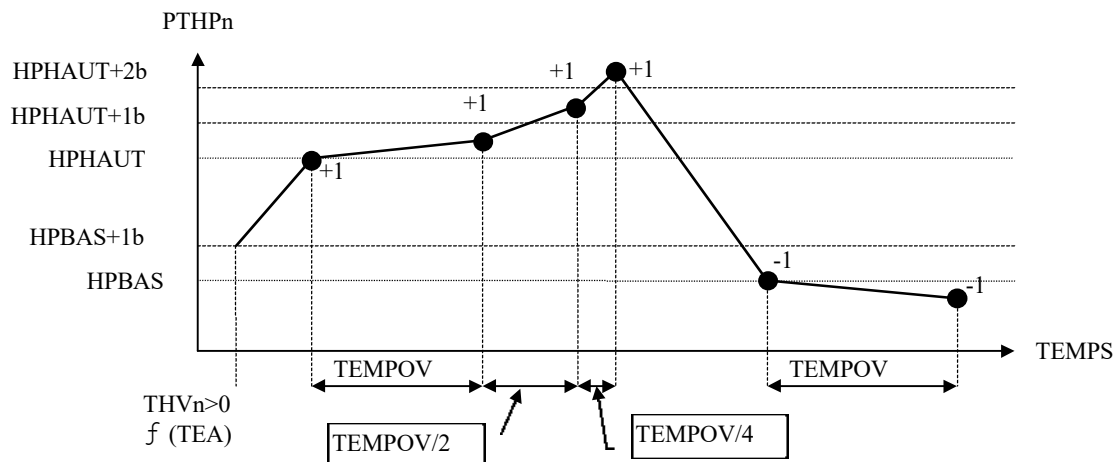

☞ Comment: when the capacity reduction of one ventilation stage involves a two-speed fan, switching from high to low speed is time-delayed by 5 seconds.



# VALVES SPECIFIC TO SCREW COMPRESSORS

## Liquid injection valve with intermediate suction

### Function

To lower the compressor discharge temperature.

### Description

The **INJLmn** liquid injection valve is open if:

- the **COMPmn** compressor is running
- and ● **TREFmn** discharge temperature is higher than 101°C (242U).

**INJLmn** is maintained open as long as:

- the **COMPmn** compressor is running
- and ● **TREFmn** discharge temperature is higher than 91°C (236U).

## ECONOMIZER VALVE

### Function

To increase refrigeration output by increasing the liquid subcooling in the circuit.

The **ECOMn** economizer valve is open if:

- the **COMPmn** compressor is running and has been under full capacity for 2 minutes
- and ● **TREFmn** discharge temperature is higher than  $\theta$
- and ● the high pressure in **PTHPn** circuit n is greater than P1.

**ECOMn** is maintained open as long as:

- the **COMPmn** compressor is running and under full capacity
- and ● **TREFmn** discharge temperature is greater ( $\theta - 2^\circ\text{C}$ )
- and ● the high pressure in **PTHPn** circuit n is greater than P2.

	$\theta$ (°C)	P1 (absolute bars)	P2 (absolute bars)
R22	65	11.9	11.2
R134a	40	7.7	6.7
R407C	45	13.5	11.7

# OPTIONS

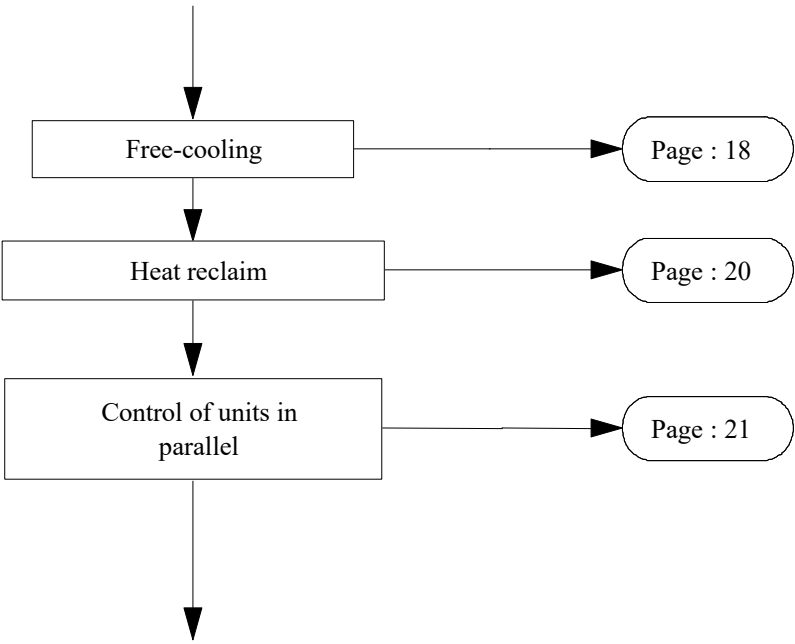

# FREE-COOLING

## Function

To ensure refrigeration output by optimizing the use of free-cooling, thus keeping electricity consumption to a minimum.

## Description

### Free-cooling functional diagram

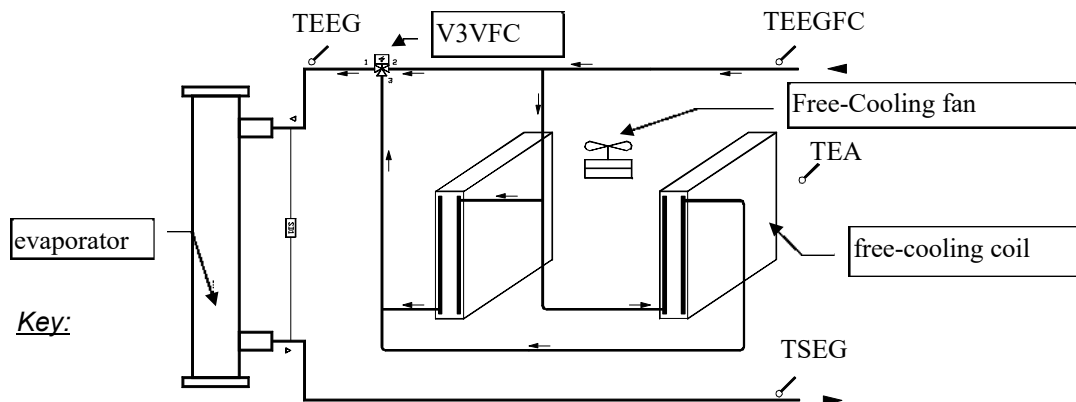

Key:

- TEEGFC ⇨ chilled water inlet temperature at free-cooling
- TEEG ⇨ chilled water inlet temperature at evaporator
- TSEG ⇨ chilled water outlet temperature
- TEA ⇨ temperature of outside air
- V3VFC ⇨ free-cooling three-way valve

### Control of free-cooling three-way valves:

V3VFC is supplied if all the following conditions are satisfied:

- ⇨ TEEGFC is greater than the control setpoint.
- ⇨  $TEA < TEEGFC - 2^{\circ}K$ .
- ⇨ The pump has been running for at least 30 seconds.
- ⇨ The three-way valve has remained idle for 3 minutes.
- ⇨ The free-cooling water inlet sensor is not defective.

V3VFC is supplied as long as all the following conditions are satisfied:

- ⇨ TEEGFC is not lower than the control setpoint.
- ⇨  $TEA < TEEGFC$ .
- ⇨ The pump is running.
- ⇨ The free-cooling water inlet sensor is not defective.

### Control of free-cooling fans

The number of ventilation stages necessary on the coils is determined by the THERFC free-cooling thermostat. This parameter depends on the water inlet temperature at the TEEG evaporator and on the setpoint control. The thermostat is increased by one stage if TEEG remains greater than the setpoint ( $CONSREG + 0.5^{\circ}C$ ) for more than three minutes. As long as this condition on TEEG is confirmed, THERFC continues to be increased by one stage every three minutes.

# FREE-COOLING (CONT.)

If TEEG remains lower than (CONSREG-0.5°C), the free-cooling thermostat is decreased by one stage every 3 minutes.

When TEEGFC drops below the setpoint, all ventilation stages are stopped.

If the THER compressor control thermostat demands at least one control stage while the free-cooling is in service, the free-cooling thermostat is forced to its maximum.

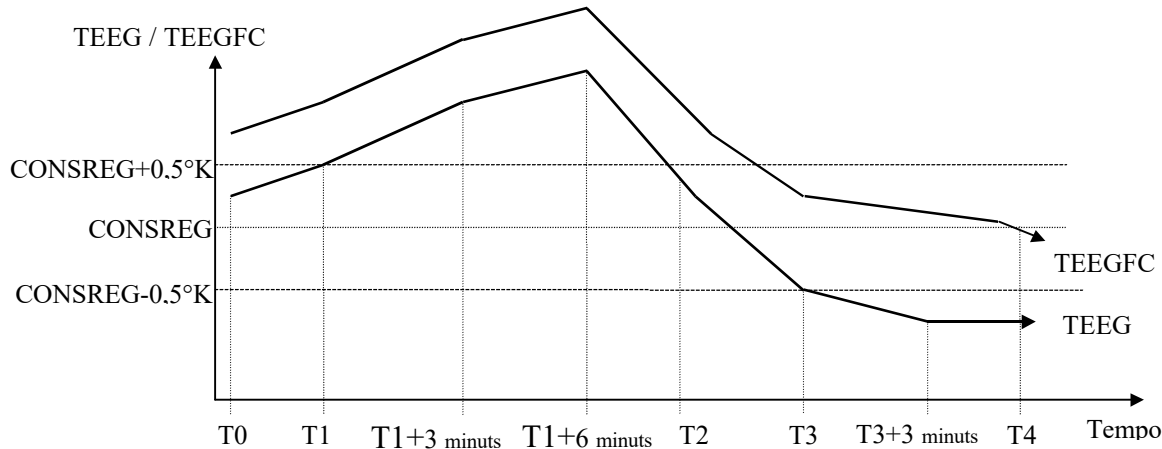

Description of different parameters:

- CONSREG ⇒ Control set point
- TEEG ⇒ Chilled water inlet temperature
- TEEGFC ⇒ Free-cooling Chilled water inlet temperature

To T0 and T1 :	THERFC stays the same
To T1+3 minutes & T1+6 minutes	THERFC=THERFC+1
to T2 & T3 :	THERFC stays the same
To T3 +3 minuti	THERFC=THERFC-1
to T4	THERFC=0

☞ Authorization for compressor start up

Authorization for compressor start up, at the same time as the free-cooling operation, is characterized by the **AUTOCP** variable.

AUTOCP depends on the following parameters:

- ⇒ the V3VFC free-cooling three-way valve
- ⇒ the THERFC free-cooling control thermostat
- ⇒ the THER compressor control thermostat
- ⇒ and the time.

AUTOCP switches to 1 if:

- THERFC is at its maximum and TEEG has been greater than CONSREG for more than **3 minutes**
- or ● V3VFC is not supplied.

AUTOCP is maintained on 1 as long as:

- THER is strictly positive
- or ● V3VFC is not supplied.

# HEAT RECLAIM

## Function

To maintain the hot water temperature at the condenser outlet as close as possible to the setpoint (of hot water), by adapting the number of fans in service to the use heat load.

## Description

### Heat reclaim functional diagram

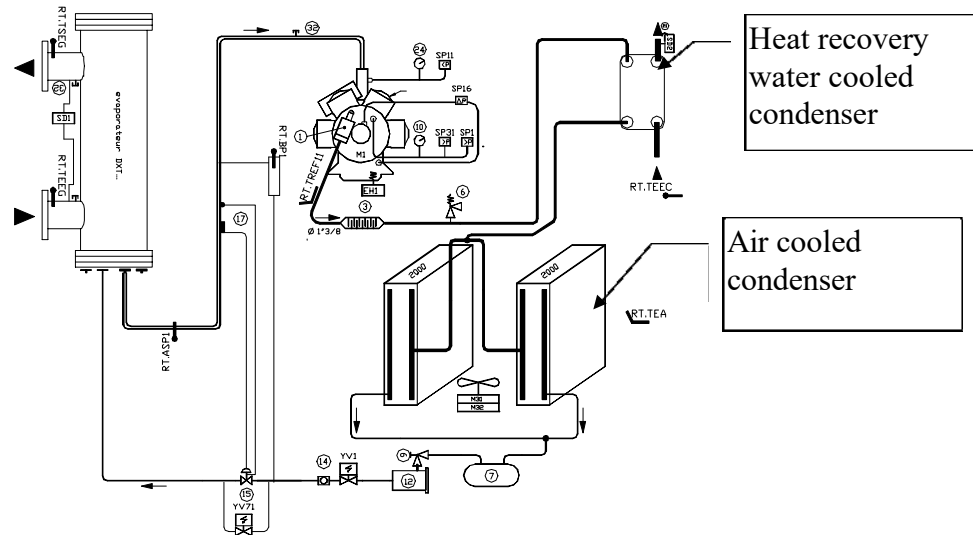

### Determining the heat reclaim method

The heat operating method is characterized by the **RECUP** parameter.

RECUP = 1 ⇔ heat reclaim.

RECUP = 0 ⇔ total rejection.

RECUP switches to 1 if:

- the **FSR** reclaim condenser flow controller has been actuated for more than 15 seconds
- and** ● the **TSECR** hot water outlet temperature is lower than the **CONSEH** hot water setpoint.

RECUP is maintained on 1 as long as:

- FSR has not been idle for more than 15 seconds
- and** ●  $TSECR < CONSEH + 2^{\circ}C$ .

### Condenser fan management

Upon switching to reclaim mode, the ventilation thermostat in the **THVn** circuit n is forced to 0 for 5 seconds. If the high pressure in circuit n exceeds 23 bars, THVn is increased by 1 stage. The ventilation thermostat continues to be increased by 1 every TEMPOV, as long as the condition on the pressure is satisfied. Whenever THVn is increased, the TSECR hot water outlet temperature value is memorized in the MTSECR variable.

In reclaim mode, if TSECR becomes lower than MTSECR while at least one fan is running, the ventilation thermostat is decremented.

**On water-cooled condenser units, the CLIMATIC does not manage reclaim control.**

# CONTROL OF UNITS IN PARALLEL

## Function

To ensure staging of the units among themselves in order to adjust the temperature of the cooled fluid as close as possible to the setpoint.

## Description

### ① Control with an additional board (recommended configuration)

The dialogue between boards is carried out only via potential free contacts without linking. The board ensuring general control of the units is numbered 6.

#### a - Hydraulic functional diagram

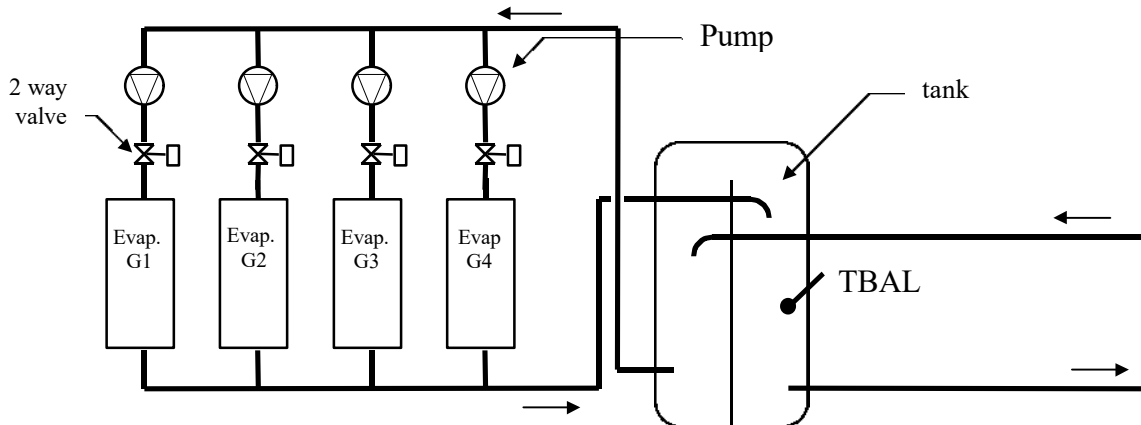

#### b - Unit thermostat

The thermostat controls the start-ups and shutdowns of the units. It is calculated according to the temperature of chilled water in the tank as follows:

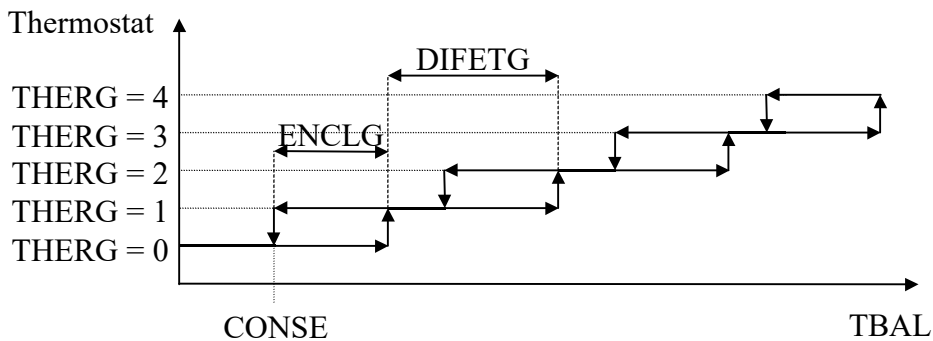

- ENCLG ⇒ Operating differential of one stage (°K)
- DIFETG ⇒ Differential between stages (°K)
- THERG ⇒ Unit thermostat
- TBAL ⇒ Temperature of chilled water in the tank
- CONSEG ⇒ Control water setpoint of unit (°C)

The THERG thermostat is limited by the **NBRG** setpoint (number of units in parallel (min. 2 max. 7))

# CONTROL OF UNITS IN PARALLEL

## ☞ Example of control:

CONSEG = 6°C  
 ENCLG = 1,5°C  
 DIFETG = 1,5°C

THERG	Cut-in	THERG	Cut out
000 ⇨ 001	7,5°C	001 ⇨ 000	6°C
001 ⇨ 002	9°C	002 ⇨ 001	7,5°C
002 ⇨ 003	10,5°C	003 ⇨ 002	9°C
003 ⇨ 004	12°C	004 ⇨ 003	10,5°C

## Comment:

The thermostat is authorized to increase by one stage only if it has not been increased for a minimum length of time, adjustable at **TP THERM** setpoint

THERG is authorized to decrement by one stage only if it has not been decreased for at least one time, adjustable at **TP THERD** setpoint

### **c - Control of evaporator isolating valves in each unit**

The control board issues the order for opening valve n (**V2Vn=1**) if the THERG control thermostat demands the operation of unit n.

### **d - Authorization for units to operate**

The control board authorizes the start up of unit n (**MAARGn=1**) according to the THERG control thermostat value and after the lapse of an adjustable time-delay, **TPV2V**, which is activated as soon as the command is sent to open 2 way valve n.

The potential free contact representing the operating authorization for unit n is to be wired to the input of the remote On/Off on the 24EL board of unit n.

### **e - Management of unit defaults and relève**

Each unit sends an availability state back to the general control board.

Depending on the state of availability of all the units, the control board determines an optimum order of priority (machines without defaults are given top priority).

If all units are available, priority changes **automatically once a week, Monday at 6 p.m.**

### **f - Control of each unit**

Each unit controls its own compressors according to its setpoint (see “cold thermostat” section). The setpoints of each unit must all be set on the same value as the setpoint of the general control board. Each unit manages its chilled water pump.

Priority	Startup order
0	1 2 3 4
1	4 1 2 3
2	3 4 1 2
3	2 3 4 1

# CONTROL OF UNITS IN PARALLEL

## g - Alarm

If the tank temperature sensor is defective, all V2Vn valves are opened, and after the TPV2V time-delay, and all units are authorised to operate. Each unit will control independently. The remote default return is time-delayed by 6 minutes.

## ⊗ Control with an inter-board link

Dialogue between boards is carried out only via the linking. The board ensuring general control is the one for unit 1, numbered 0.

### Control principle

The unit with board 0 sends the **VCONSE** control setpoint to the other units, as well as the **PRIG** priority order; this enables machine operating time to be equalized.

Priority changes **automatically once a week, Monday at 6 p.m.**

Setpoint VCONSE is equal to the control setpoint of unit 1.

Each unit has a **DIFETG** setpoint which enables the setpoint to be offset according to start up priority (see table below).

In case of default, the relève of the units is not managed.

If a machine has lost the link with unit 0, it controls on its setpoint independently of the other units. If board 0 is absent from the linking, then all the units control independently on their own setpoint.

Setpoint offset according to PRIG				
PRIG	Unit 1	Unit 2	Unit 3	Unit 4
0	VCONSE	VCONSE+DIFETFG	VCONSE+ (2 X DIFETFG)	VCONSE+ (3 X DIFETFG)
1	VCONSE+DIFETFG	VCONSE+ (2 X DIFETFG)	VCONSE+ (3 X DIFETFG)	VCONSE
2	VCONSE+ (2 X DIFETFG)	VCONSE+ (3 X DIFETFG)	VCONSE	VCONSE+DIFETFG
3	VCONSE+ (3 X DIFETFG)	VCONSE	VCONSE+DIFETFG	VCONSE+ (2 X DIFETFG)



# MACHINE AVAILABILITY TEST

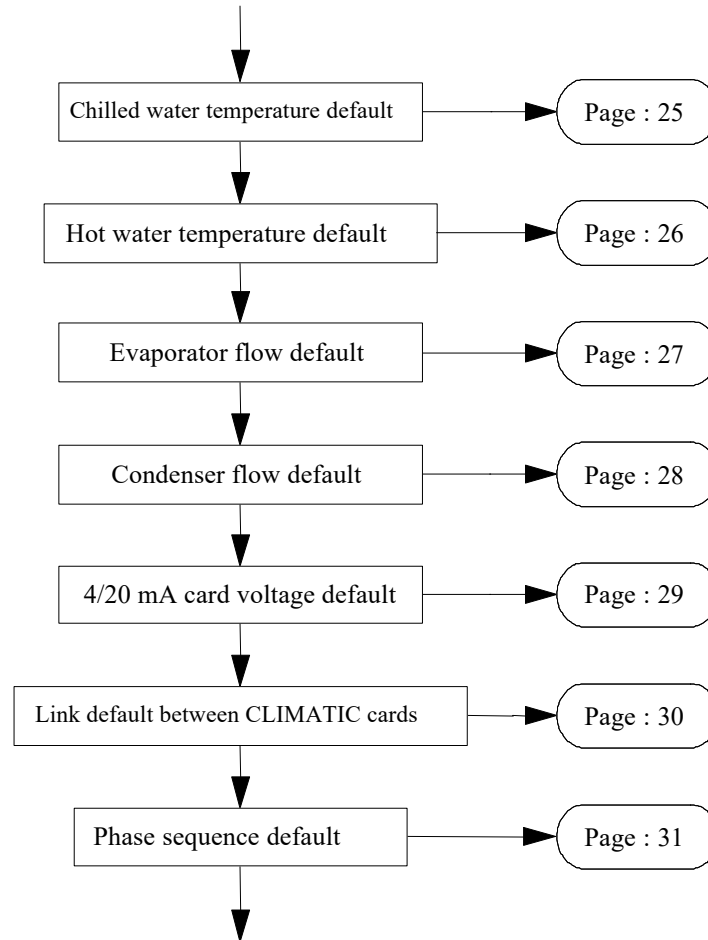

# CHILLED WATER SENSOR DEFAULT

**Type of default:** Machine incident

**Incident code:** 001

**Variable:** PANM

## Description

The chilled water inlet or outlet temperature measured by the sensor is outside the authorized range:

TEEG < TEGI or TEEG > 65°C

TSEG < TEGI or TSEG > 65°C

With:

TEEG ⇨ chilled water inlet temperature

TSEG ⇨ chilled water outlet temperature

TEGI ⇨ minimum temperature of water at evaporator

## Action

- ☞ Immediate shutdown of the machine.
- ☞ The default is shown on the display unit.
- ☞ The remote default return is time-delayed by 6 minutes.

## Reset

**Automatic** reset of default as soon as the water temperature measured by the sensor returns to the normal operating range:

TEEG > TEGI+2°C and TEEG < 60°C

TSEG > TEGI+2°C and TSEG < 60°C

## Diagnosis help

Defective chilled water inlet or outlet sensor.  
Faulty wiring or disconnection of sensor.

## Return to normal

Replace the sensor.  
Check the sensor connection.

# HOT WATER SENSOR DEFAULT

**Type of default:** Machine incident

**Incident code:** 002

**Variable:** PANM

## Description

The hot water inlet temperature measured by the sensor is outside the authorized range:

TEEC <-27°C or TEEC> TECS

With:

TEEC ⇨ hot water inlet temperature

TECS ⇨ maximum temperature of water at condenser

## Action

- ☞ Immediate shutdown of the machine.
- ☞ The default is shown on the display unit.
- ☞ The remote default return is time-delayed by 6 minutes.

## Reset

**Automatic** reset of default as soon as the water temperature measured by the sensor returns to the normal operating range:

TEEC > -27°C and TEEC < TECS-5°C

## Diagnosis help

Defective hot water inlet sensor.  
Faulty wiring or disconnection of sensor.

## Return to normal

Replace the sensor.  
Check the sensor connection.

# EVAPORATOR FLOW DEFAULT

**Type of default:** Machine incident

**Incident code:** 003

**Variable:** PANM

## Description

The pump supplying the evaporator has had the order to operate since **20 seconds**.  
The "flow switch" (FSE) detects insufficient flow in the evaporator.

## Action



If the default lasts more than **3 seconds**:

- ☞ Immediate shutdown of the machine.
- ☞ The default is shown on the display unit.
- ☞ The remote default return is time-delayed by 6 minutes

If the default lasts more than **20 seconds**:

- ☞ Immediate shutdown of the pump in service.
- ☞ The default is shown on the display unit.
- ☞ The remote default return is time-delayed by 6 minutes.

## Reset

Manual reset ⇒ simultaneously press the    keys on the display unit

❶ The unit is not controlling **any pump** (DEUXPOMPE=0):

The machine restarts **automatically** 20 seconds after the flow is reestablished.  
(The CLIMATIC detects that it is not controlling any pumps if POMPE1 = 0 and FSE = 1).

❷ The unit is controlling **one pump** (DEUXPOMPE=0):

If the default has lasted less than 20 seconds, the machine restarts **automatically** 20 seconds after the flow is reestablished.  
If the default has lasted more than 20 seconds, the machine can restart only after a manual reset.

❸ The unit is controlling **two pumps** (DEUXPOMPE=1):

If the default has lasted less than 20 seconds, the machine restarts **automatically** 20 seconds after the flow is reestablished.  
If the default has lasted more than 20 seconds, the CLIMATIC orders the second pump to restart (if it is available). If the flow is reestablished within 20 seconds, the machine restarts **automatically**. Otherwise, the unit can return to service only after a manual reset.

With:

DEUXPOMPE ⇒ choice of pump number (OFF = 0 or 1 pump, ON = 2 pumps)

## Diagnosis help

Faulty wiring of pump control.  
Faulty wiring of flow controller.  
Water filter clogged up.  
Faulty adjustment of flow controller.

## Return to normal

Check the pump connection.  
Check the flow controller connection.  
Clean the water filter.  
Adjust the flow controller.

# CONDENSER FLOW DEFAULT

**Type of default:** Machine incident

**Incident code:** 004

**Variable:** PANM

## Description

“Flow switch” (FSC) detects an insufficient flow in the condenser.

## Action

If the default lasts more than **3 seconds**:

- ☞ Immediate shutdown of the machine.
- ☞ The default is shown on the display unit.
- ☞ The remote default return is time-delayed by 6 minutes.

## Reset

Manual reset ⇒ simultaneously press the  keys on the display unit

The machine restarts **automatically** 20 seconds after the flow is reestablished.

## Diagnosis help

Faulty wiring of pump control.  
 Faulty wiring of flow controller.  
 Water filter clogged up.  
 Faulty adjustment of flow controller.

## Return to normal

Check pump connection.  
 Check flow controller connection.  
 Clean water filter.  
 Adjust flow controller.

# POWER DEFAULT ON 4/20MA BOARD

**Type of default:** Machine incident

**Incident code:** 007

**Variable:** PANM

## Description

One of the 4/20mA interface boards is not electrically supplied for more than **5 seconds** (PT420MA= 0).

## Action

- ☞ Immediate shutdown of the machine.
- ☞ The default is shown on the display unit.
- ☞ The remote default return is time-delayed by 6 minutes.

## Reset

**Automatic** reset of default 2 minutes after supply for all boards is reestablished.

## Diagnosis help

Faulty wiring or disconnection of power supply.  
 Faulty wiring of voltage presence contact.  
 Melting of board fuse.

## Return to normal

Check power supply connection.  
 Check voltage presence contact. connection  
 If necessary, check or replace the fuse (100mA).

# LINK DEFAULT BETWEEN CLIMATIC BOARDS

**Type of default:** Machine incident

**Incident code:** 008

**Variable:** PANM

## Description

The link between the CLIMATIC 0 board (master) and one or more other boards is interrupted for more than **15 seconds**.

The PRECAR variable (address 165), whose value depends on the number of boards present, shows a link default.

Each board is identified by a specific value :

Card 0 (master) ⇒ 1	Card 4 (slave) ⇒ 16
Card 1 (slave) ⇒ 2	Card 5 (slave) ⇒ 32
Card 2 (slave) ⇒ 4	Card 6 (slave) ⇒ 64
Card 3 (slave) ⇒ 8	Card 7 (slave) ⇒ 128

If the three-wire link connects boards 0, 1, 2 and 3, the value of PRECAR must be equal to 15 (addition of values). If the value is only equal to 7, this means that board 3 is not detected.

## Action

- ☞ Immediate shutdown of the machine and resetting of boards (**3 attempts**).
- ☞ The default is shown on the display unit.
- ☞ The remote default return is time-delayed by 6 minutes.

After **3 attempts** to reinitialize the boards, only the boards still in connection with board 0 continue to operate.

## Reset

**Automatic** reset of default, 3 minutes after the link between all the boards is reestablished.

## Diagnosis help

Faulty wiring of link between boards.  
Lack of voltage on one of the boards.  
Faulty positioning of jumpers G6, G7.

## Return to normal

Check connection of link between boards.  
Check electric power-supply of boards.  
Check position of jumpers (see wiring diagram).

# PHASE SEQUENCE DEFAULT

**Type of default:** Machine incident

**Incident code:** 009

**Variable:** PANM



## Description

The phase controller is tripped (PHASE = 0).  
It detects a reversal or faulty phase connection.

## Action

- ☞ Immediate shutdown of the machine.
- ☞ The default is shown on the display unit.
- ☞ The remote default return is time-delayed by 6 minutes.

## Reset

Manual reset ⇒ simultaneously press the    keys on the display unit

The machine can restart only after a **manual** reset and disappearance of the default.

**Comment:** When powered down, the incident is not memorized. Therefore, when powered back up, the unit restarts **automatically** if the default has disappeared.

## Diagnosis help

Absence of a phase on the power-supply.  
Default when initially powered up.  
Faulty wiring of phase presence contact.

## Return to normal

Check presence of the three phases and value of voltage between phases.  
Reverse two of the three phases upstream of the unit.  
Check the phase presence contact wiring.



# MISCELLANEOUS DEFAULT TEST

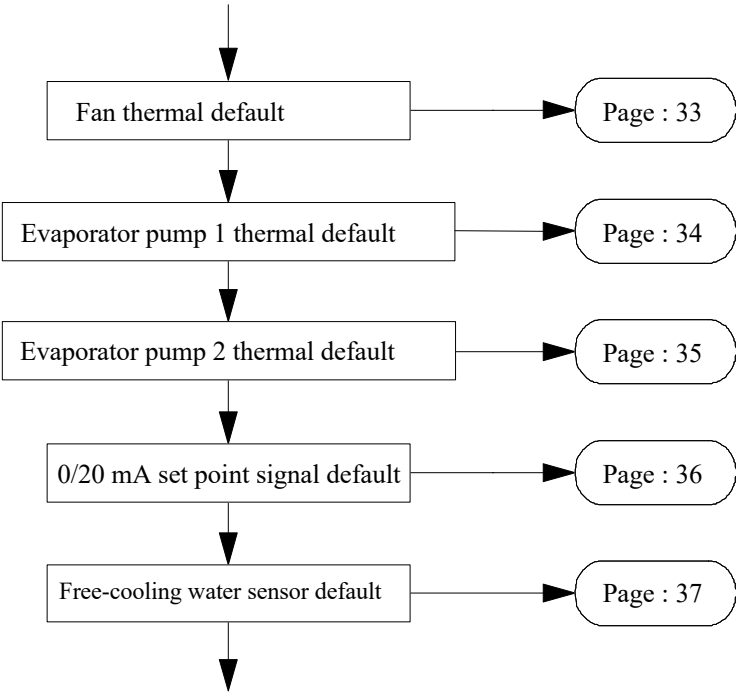

# FAN POWER DEFAULT

**Type of default:** Miscellaneous incident

**Incident code:** 090

**Variable:** PAND

## Description

The circuit-breaker of at least one fan is tripped. (ELECV=0)

## Action

- ☞ The default is shown on the display unit.
- ☞ The remote default return is time-delayed by 6 minutes.

## Reset

**Automatic** reset as soon as the default disappears.

## Diagnosis help

Faulty adjustment of circuit-breaker.  
Faulty wiring of default return.

## Return to normal

Adjust the thermal protection device according to the fan's current rating.  
Check wiring of default return.

# EVAPORATOR PUMP 1 POWER DEFAULT

**Type of default:** Miscellaneous incident

**Incident code:** 091

**Variable:** PAND

## Description

The thermal protection device or circuit-breaker of pump 1 is tripped. (ELECP1=0)

## Action

- ❶ The unit is controlling **only one pump** (DEUXPOMPE = 0):
  - ☞ Immediate shutdown of pump 1.
  - ☞ Immediate shutdown of the machine.
  - ☞ The default is shown on the display unit.
  - ☞ The remote default return is time-delayed by 6 minutes.
- ❷ The unit is controlling **two pumps** (DEUXPOMPE = 1):
  - ☞ Immediate shutdown of pump 1.
  - ☞ Immediate shutdown of the machine.
  - ☞ Start up of second pump (if pump 2 is available).
  - ☞ The default is shown on the display unit.
  - ☞ The remote default return is time-delayed by 6 minutes.

## Reset

**Automatic** reset of default.

### Case n°❶:

- ☞ The machine restarts automatically 20 seconds after the default has disappeared and after the CLIMATIC has restarted the pump.

### Case n°❷:

- ☞ Machine restarts as soon as pump 2 has been running for **20 seconds**.

**Comment:** Pump 1 can restart when the CLIMATIC gives it the order to do so, provided that the default has disappeared.

## Diagnosis help

Faulty adjustment of thermal protection device.

Faulty wiring of default return.

## Return to normal

Adjust the thermal protection device according to the pump's current rating.  
Check wiring of default return.

# EVAPORATOR PUMP 2 POWER DEFAULT

**Type of default:** Miscellaneous incident

**Incident code:** 092

**Variable:** PAND

## Description

The thermal protection device or circuit-breaker of pump 2 is tripped. (ELECP2=0)

## Action

The unit is controlling **two pumps** (DEUXPOMPE = 1).

- ☞ Immediate shutdown of pump 2.
- ☞ Immediate shutdown of the machine.
- ☞ Start up of second pump (if pump 1 is available).
- ☞ The default is shown on the display unit.
- ☞ The remote default return is time-delayed by 6 minutes.

## Reset

**Automatic** reset of default.

- ☞ Machine restarts as soon as pump 1 has been running for **20 seconds**.

**Comment:** Pump 2 can restart when the CLIMATIC gives it the order to do so, provided that the default has disappeared.

## Diagnosis help

Faulty adjustment of thermal protection device.

Faulty wiring of default return.

## Return to normal

Adjust thermal protection device according to the pump's current rating.  
Check wiring of default return.

# 4/20mA SETPOINT SIGNAL DEFAULT

**Type of default:** Miscellaneous incident

**Incident code:** 095

**Variable:** PAND

## Description

The unit should control on the water setpoint sent by the remote customer, but the value of the latter is incorrect (SCONS<48U).

## Action

- ☞ The machine is not stopped and controls on its own water setpoint.
- ☞ The default is shown on the display unit.
- ☞ The remote default return is time-delayed by 6 minutes.

## Reset

**Automatic** reset as soon as SCONS > 48U.  
The machine again controls according to the customer's setpoint.

## Diagnosis help

Faulty wiring of 0/20mA signal.

## Return to normal

Check wiring (see wiring diagram).

# FREE-COOLING WATER SENSOR DEFAULT

**Type of default:** Miscellaneous incident

**Incident code:** 097

**Variable:** PAND

## Description

The chilled water inlet temperature measured by the sensor at the free-cooling inlet is outside the authorized range:

$TEEGFC < TEGI$  or  $TEEGFC > 65^{\circ}\text{C}$

With:

TEEGFC     $\Rightarrow$  chilled water inlet temperature at free-cooling  
TEGI         $\Rightarrow$  minimum water temperature at evaporator

## Action

- ☞ Immediate shutdown of free-cooling.
- ☞ The default is shown on the display unit.
- ☞ The remote default return is time-delayed by 6 minutes.

## Reset

**Automatic** reset of default as soon as the water temperature measured by the sensor returns to the normal operating range:

$TEEGFC > TEGI + 2^{\circ}\text{C}$  and  $TEEGFC < 60^{\circ}\text{C}$

## Diagnosis help

Defective free-cooling water inlet sensor.  
Faulty wiring or disconnection of sensor.

## Return to normal

Replace the sensor.  
Check sensor connection.

# CIRCUIT AVAILABILITY TEST

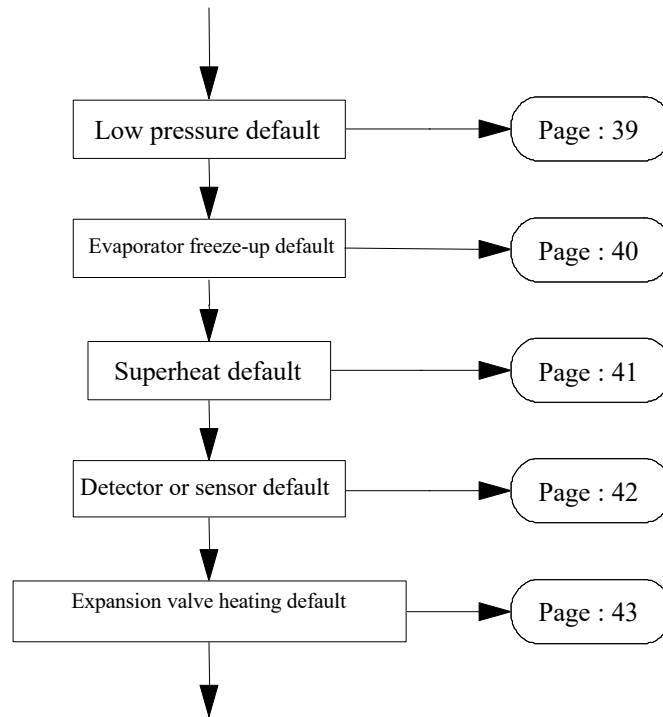

# LOW PRESSURE DEFAULT

Type of default: Circuit incident

Incident code: 001

Variable: PANc<sub>n</sub>

## Description

❶ Scroll or reciprocating compressor with +6°C ambient conditions or electronic expansion valve:  
No compressor in circuit n is running. The liquid valve has been open for 2 minutes, but the low pressure is insufficient.

❷ Screw compressor:  
One compressor on circuit n is in start up demand, but the low pressure is insufficient.

❸ Scroll or reciprocating compressor with -20°C ambient option and without electronic expansion valve:  
One compressor on circuit n has been running for more than 2 minutes. The liquid valve is open and the expansion by-pass valve has been closed for 1 minute, but the low pressure is insufficient.

All types of machines except those equipped with -20°C operation:

One compressor on circuit n has been running for more than 2 minutes and an insufficient low pressure is detected.



All types of machines:

One compressor on circuit n has been running for more than 6 minutes; all other compressors in service in the circuit have been running for at least 2 minutes and an insufficient low pressure is detected.

## Action

- ☞ If circuit n is not running, it is not authorized to start up. If it is running, it is immediately stopped.
- ☞ The default is shown on the display unit.
- ☞ The remote default return is time-delayed by 6 minutes.

## Reset

Manual reset ⇒ simultaneously press the    keys on the display unit

**Case n°❶:** *Two automatic resets* are authorized every day. After this, the machine can start up only after a manual reset.

**Case n°❷:** The reset is *manual*.

**Case n°❸:** *Four automatic resets* are authorized every day. After this, the reset is *manual*.

**Case n° :** *two automatic resets are allowed* daily. After this, the reset is *manual*.

**Case n° :** The reset is *manual*.

**Comment:** The TOBP<sub>n</sub> “low pressure” incident counters are all *reset daily at 6 p.m.*, provided that the maximum number of authorized defaults is not reached.

## Diagnosis help

Insufficient charge in the circuit.  
Faulty operation of liquid solenoid valve.  
Faulty operation of expansion valve.  
Drier clogged up.

## Return to normal

Top up the charge.  
Check operation of solenoid valve.  
Check operation of expansion valve.  
Change the drier.



# EVAPORATOR FREEZE-UP DEFAULT

**Type of default:** Circuit incident

**Incident code:** 002

**Variable:** PANc<sub>n</sub>

## Description

### ❶ Shell and tube heat-exchangers:

Compressor m in circuit n is running, evaporation temperature (TBP<sub>n</sub>) remains less than evaporation minimum temperature (TBPI) setpoint, and suction temperature (TASP<sub>n</sub>) remains less than +5°C for more than **2 minutes**.

TBP<sub>n</sub> < TBPI and TASP<sub>n</sub> < +5°C

### ❷ Plate heat exchangers:

● One compressor m in circuit n is running, evaporation temperature (TBP<sub>n</sub>) remains less than evaporation minimum temperature (TBPI) setpoint and suction temperature remains less than +5°C for more than 30 seconds

TBP<sub>n</sub> < TBPI and TASP<sub>n</sub> < +5°C

or ● the water outlet (TSEG) is less than +3°C.

TSEGN < +3°C

***In case of a machine which is to cool a coolant to a temperature less than +5°C and for which the water necessarily includes an water/anti-freeze solution, the freeze-up default is not managed.***

## Action

- ☞ Immediate shutdown of circuit.
- ☞ The default is shown on the display unit.
- ☞ The remote default return is time-delayed by 6 minutes.

## Reset

Manual reset ⇒ simultaneously press the    keys on the display unit

At the first default, the reset is **automatic** after **30 minutes**, if the low pressure temperature is **higher than +1°C**.

After this, the reset is **manual**.

**Comment:** The TOGEL<sub>n</sub> “freeze-up” incident counters are all **reset daily at 6 p.m.**, provided that the maximum number of authorized defaults is not reached.

## Diagnosis help

Faulty adjustment of setpoints.  
Defective evaporation, suction or chilled water outlet sensor.  
Faulty wiring or disconnection of sensor.  
Insufficient flow in evaporator.

## Return to normal

Check adjustment of setpoints.  
Replace the sensor.  
Check sensor connection.  
Check flow and flow controller adjustment.

# SUPERHEAT DEFAULT

**Type of default:** Circuit incident

**Incident code:** 004

**Variable:** PANc<sub>n</sub>

## Description

The default is managed only on units equipped with electric expansion valves

### Case n°1:

After 2 minutes of operation of a compressor on circuit n, the suction temperature (TASP<sub>n</sub>) is higher than the chilled water inlet temperature (TEEG) by 3°C.

$$TASP_n > (TEEG + 3^\circ\text{C})$$

### Case n°2:

After 2 minutes of operation of a compressor on circuit n, the difference between the suction temperature (TASP<sub>n</sub>) and the evaporation temperature (TBP<sub>n</sub>) is less than 2°C.

$$(TASP_n - TBP_n) < 2^\circ\text{C}$$

## Action

- ☞ Immediate shutdown of circuit n.
- ☞ The default is shown on the display unit.
- ☞ The remote default return is time-delayed by 6 minutes.

## Reset

Manual reset ⇒ simultaneously press the + - V keys on the display unit

The default reset is **manual**.

## Diagnosis help

Defective evaporation, suction or chilled water inlet sensor.  
Faulty wiring or disconnection of sensor.

## Return to normal

Replace the sensor.  
Check sensor connection.

# SENSOR OR DETECTOR DEFAULT

**Type of default:** Circuit incident

**Incident code:** 006

**Variable:** PANc<sub>n</sub>

## Description

One or more detectors or sensors are in default: either in short-circuit, or cut out or disconnected.  
The relevant sensors are:

- RDE<sub>Tn</sub> ⇒ electric expansion valve internal sensor (245U < RDE<sub>Tn</sub> < 5U)
- PTBP<sub>n</sub> ⇒ LP pressure sensor (if sensor presence (48U < BP<sub>n</sub>))
- TBP<sub>n</sub> ⇒ evaporation temperature sensor (unit without LP sensor (5U < TBP<sub>n</sub>))
- PTHP<sub>n</sub> ⇒ HP pressure sensor (if sensor presence (48U < HP<sub>n</sub>))
- TASP<sub>n</sub> ⇒ suction temperature sensor (5U < TASP<sub>n</sub>)

**Comment:** All of these detectors and sensors are not necessarily present on a single machine.

## Action

- ☞ Immediate shutdown of circuit n.
- ☞ The default is shown on the display unit.
- ☞ The remote default return is time-delayed by 6 minutes.



## Reset

Manual reset ⇒ simultaneously press the keys on the display unit

The default reset is **manual**.

## Diagnosis help

Sensor defective.  
Faulty wiring or disconnection of one or more sensors.

## Return to normal

Replace the sensor.  
Check connection of sensors.

# EXPANSION VALVE HEATING DEFAULT

**Type of default:** Circuit incident

**Incident code:** 007

**Variable:** PANc<sub>n</sub>

## Description

No compressor in circuit n is operating. One compressor is in start up demand and heating of the expansion valve is authorized.

After **6 minutes**, the opening value of the expansion valve necessary for start up of the compressor has not been reached.

## Action

- ☞ Circuit n is not authorized to start up.
- ☞ The default is shown on the display unit.
- ☞ The remote default return is time-delayed by 6 minutes.

## Reset

Manual reset ⇒ simultaneously press the **+** **-** **V** keys on the display unit

The default reset is **manual**.

## Diagnosis help

Defective expansion valve sensor.  
 Faulty wiring or disconnection of sensor.  
 24V power-supply default on expansion valve.  
 The green LED of the static relay is lit up but the expansion valve is not heating.

## Return to normal

Replace the expansion valve.  
 Check sensor connection.  
 Check power-supply.  
 Check the 8RS2ST board, or the static relay.

# COMPRESSOR AVAILABILITY TEST

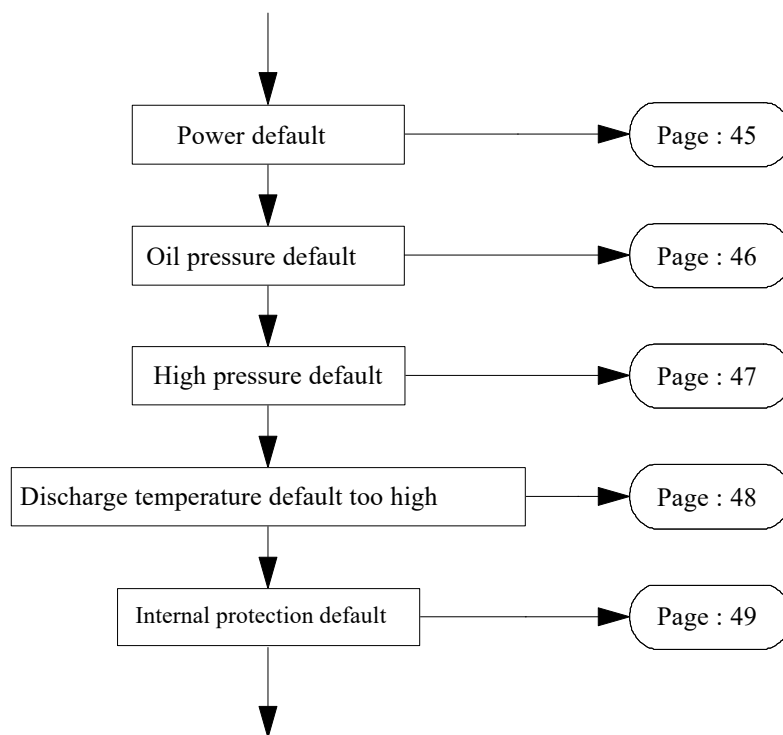

# POWER DEFAULT

**Type of default:** Compressor incident

**Incident code:** 001

**Variable:** PANmn

## Description

The circuit-breaker of compressor mn has tripped.

## Action

- ☞ Immediate shutdown of compressor mn.
- ☞ The default is shown on the display unit.
- ☞ The remote default return is time-delayed by 6 minutes.

## Reset

Manual reset ⇒ simultaneously press the    keys on the display unit

The default reset is **manual**.

## Diagnosis help

Faulty connection or tightening of connections.  
Faulty calibration of circuit-breaker.

## Return to normal

Verify the connections.  
Check calibration in relation to the compressor current rating.

# OIL PRESSURE DEFAULT

**Type of default:** Compressor incident

**Incident code:** 002

**Variable:** PANmn

## Description

**❶** Reciprocating semi-hermetic compressor units:

The sum of the periods for which the oil pressure switch of POILmn compressor mn remains tripped exceeds **90 seconds**. The oil pressure is too low to ensure proper lubrication of the compressor.

**Comment:** The low oil pressure period counter is reset if the oil pressure switch remains above its cut-in point for more than 3 minutes.

**❷** Screw compressors:

The oil pressure switch of POILmn compressor mn remains tripped for more than **5 seconds**. The oil pressure is too low to ensure proper lubrication of the compressor.

## Action

- ☞ Immediate shutdown of compressor mn.
- ☞ The default is shown on the display unit.
- ☞ The remote default return is time-delayed by 6 minutes.

## Reset

Manual reset ⇒ simultaneously press the **+** **-** **V** keys on the display unit

At the first default, the reset is **automatic**. After that, it is **manual**.

**Comment:** The TOOILmn “oil pressure” incident counters are all **reset daily at 6 p.m.**, provided that the maximum number of authorized defaults is not reached.

## Diagnosis help

Lack of oil in compressor.  
 Oil filter clogged up.  
 Faulty adjustment of oil pressure switch.  
 Faulty wiring of oil pressure switch.

## Return to normal

Check the oil charge.  
 Changer the oil filter.  
 Check adjustment of oil pressure switch.  
 Check wiring of oil pressure switch.

# HIGH PRESSURE DEFAULT

**Type of default:** Compressor incident

**Incident code:** 005

**Variable:** PANmn

## Description

The high pressure pressure switch of PHPmn compressor mn has tripped.

## Action

- ☞ Immediate shutdown of compressor mn.
- ☞ The default is shown on the display unit.
- ☞ The remote default return is time-delayed by 6 minutes.

## Reset

Manual reset ⇒ simultaneously press the    keys on the display unit

The reset of the first two defaults is **automatic**. After this, the reset is **manual**.

**Comment:** The TOHPmn “high pressure” incident counters are all **reset daily at 6 p.m.**, provided that the maximum number of authorized defaults is not reached.

## Diagnosis help

Condenser clogged up.  
 Faulty adjustment of the condensation control parameters.  
 Faulty operation of liquid solenoid valve.  
 Drier clogged up.  
 Faulty adjustment of high pressure pressure switch.  
 Faulty wiring of high pressure pressure switch.

## Return to normal

Clean the condenser.  
 Check adjustment of parameters.  
 Check operation of solenoid valve.  
 Replace the drier.  
 Check adjustment of high pressure pressure switch.  
 Check wiring of high pressure pressure switch.



# DISCHARGE TEMPERATURE DEFAULT TOO HIGH

Type of default: Compressor incident	Incident code: 006	Variable: PANmn
Description	<p>❶ Scroll or reciprocating compressor: The discharge temperature of compressor mn <b>exceeds 120°C</b> for more than <b>9 seconds</b>. REFmn&gt;250U</p> <p>❷ Screw compressor: The discharge temperature of compressor mn <b>exceeds 107°C</b> for more than <b>9 seconds</b>. REFmn&gt;245U</p>	
Action	<ul style="list-style-type: none"> <li>☞ Immediate shutdown of compressor mn.</li> <li>☞ The default is shown on the display unit.</li> <li>☞ The remote default return is time-delayed by 6 minutes.</li> </ul>	
Reset	Manual reset ⇒ simultaneously press the <input type="button" value="+"/> <input type="button" value="-"/> <input type="button" value="V"/> keys on the display unit	
<p>The reset of the first two defaults is <b>automatic</b> after a time-delay of <b>30 minutes</b>. After this, the reset is <b>manual</b>.</p> <p><b>Comment:</b> The TOREFmn “discharge too high” incident counters are all <b>reset daily at 6 p.m.</b>, provided that the maximum number of authorized defaults is not reached.</p>		
Diagnosis help	Return to normal	
<p>Defective discharge sensor. Faulty wiring of sensor. Charge in circuit insufficient. Superheat set on a value which is too high.</p>		<p>Replace the sensor. Check sensor connection. Check the charge. Check adjustment of superheat.</p>

# INTERNAL PROTECTION DEFAULT

**Type of default:** Compressor incident

**Incident code:** 007

**Variable:** PANmn

## Description

❶ Scroll and semi-hermetic compressor units:

The thermal protection of motor windings of **PINTmn** compressor mn is tripped.

❷ Reciprocating hermetically-sealed compressor units:

Compressor mn has been running for **6 minutes** and the discharge temperature is lower than  $\theta$ . This phenomenon shows that the compressor internal protection is tripped.



	$\theta$ (°C)
R22	40
R134a	30
R407C	40

## Action

- ☞ Immediate shutdown of the compressor.
- ☞ The default is shown on the display unit.
- ☞ The remote default return is time-delayed by 6 minutes.

**Comment:** When powered down, the default is not memorized.

## Reset

Manual reset ⇒ simultaneously press the    keys on the display unit

The default reset is **manual**.

## Diagnosis help

Power-supply default of the internal protection relay.  
Defective discharge sensor (reciprocating hermetically-sealed compressor units).  
Faulty wiring or disconnection of sensor.  
Superheat set on a value which is too high.

## Return to normal

Check the relay power-supply.  
Replace the sensor.  
  
Check the sensor connection.  
Check adjustment of superheat.

# TECHNICAL DATA SHEET



# CLIMATIC BOARD

## TECHNICAL DATA SHEET

### ① CLIMATIC overview

The CLIMATIC is a thermal control stand-alone programmable automatic controller.

Materially, it is represented by an extensible microprocessor board, with 16 analog inputs and 8 logic outputs in its basic version.

- ☞ Temperature or pressure sensors are connected to the analog inputs.
- ☞ Control relays (compressors, fans, etc...) are connected to the outputs.

The system is entirely 'stand-alone', due to:

- ☞ a 12V alternating current power-supply
- ☞ an extension for additional logic outputs (8RS 2ST board, or 8rs 2ANA board)
- ☞ a liquid crystal display unit (of the CL02 analog type, or CL07 analog and alphanumerical)
- ☞ an extension for logic inputs (24EL board)
- ☞ an interface for 0/20mA signal input (4/20mA board)
- ☞ a serial link (RS232 300 baud type) for dialogue with:
  - a microcomputer, or a modem via the RS232 interface,
  - or with a BMS through means of the JBUS gateway.

### ② Replacement of a CLIMATIC board

#### Procedure to be followed:

- ☞ Note the value of all setpoints.
- ☞ Cut the board power-supply off and change the board.
- ☞ Recover the EPROM from the former board and refit it on the new one (see drawing below).
- ☞ Check the configuration of switches G4 to G7.
- ☞ Reconnect all connections on the CLIMATIC, referring to the wiring diagram.
- ☞ Put the battery jumper on work position (T).
- ☞ Re-energize the board and enter the former setpoints on the new board.

**Comment:** It is recommended that connectors J12, J13 and J16 never be connected or disconnected when the board is energized.

Be careful not to **reverse** the connections of **J12 and J16 connectors**. This could result in the destruction of a board.

#### EPROM mounting direction:

Mating device

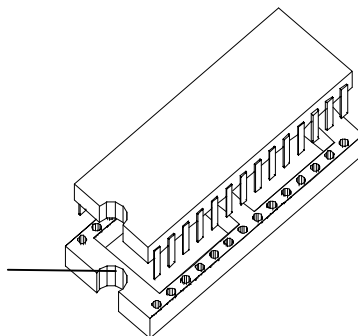

# CLIMATIC BOARD

## TECHNICAL DATA SHEET

### Configuration of switches G4 to G7

#### Switches G6 and G7

If there is no link between boards: do not modify the switch configuration

If there is a link between boards (maximum of 8): position the switches as follows

Card 0 (master)	G6 = 2-3 G7 = 2-3	Card n (slave)	G6 = 1-2 G7 = 1-2
-----------------	----------------------	----------------	----------------------

#### G4 and G5 switches

If there is no link with a PC, or a modem, etc...: do not modify the switch configuration

If there is a link with a PC, etc...: position the switches as follows (maximum of 8 boards on a single link)

Card 0 (master)	G4 = 1-2 G5 = 1-2	Card n (slave)	G4 = 1-2 G5 = 1-2
-----------------	----------------------	----------------	----------------------

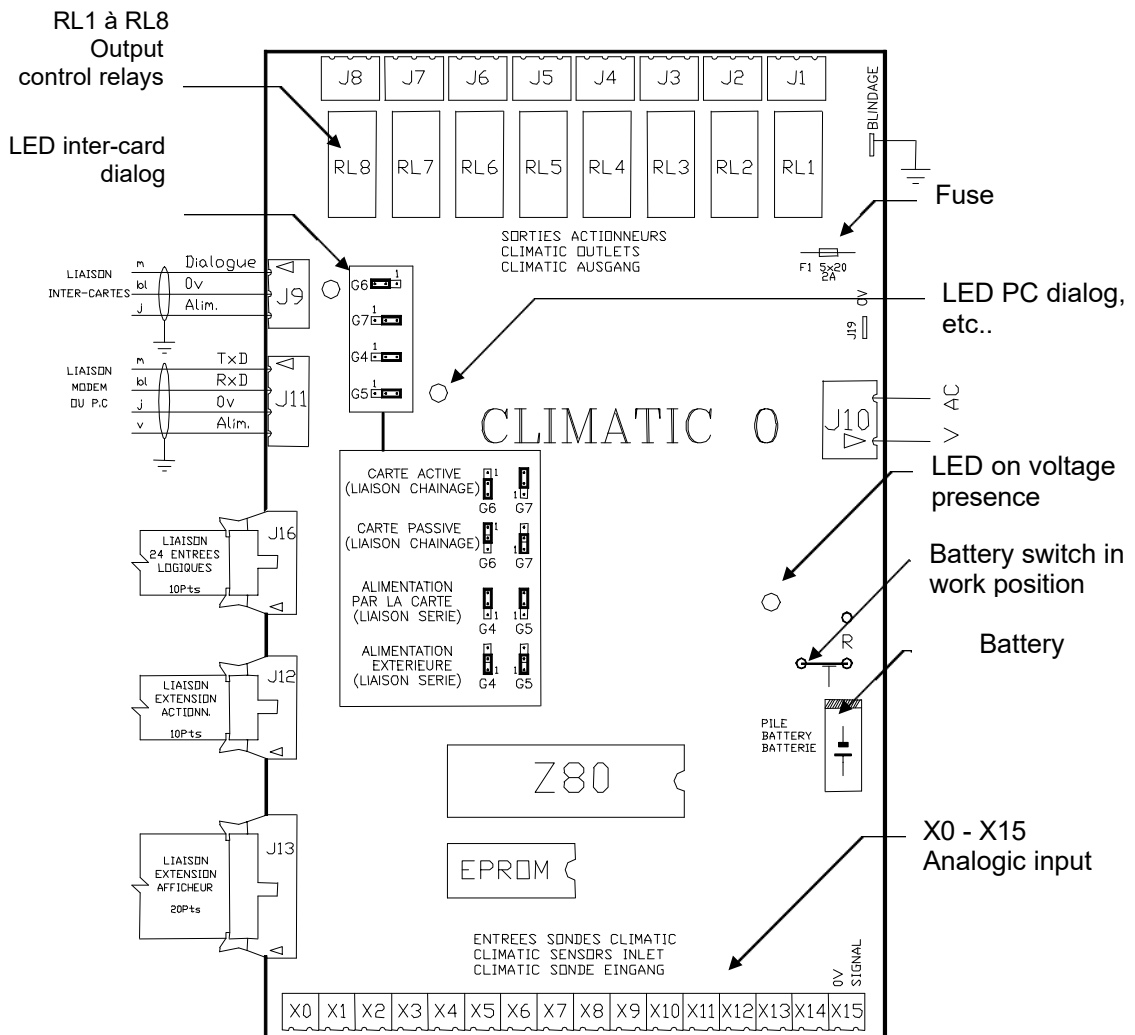

# CLIMATIC - RS232 INTERFACE TECHNICAL DATA SHEET

The RS232 interface takes the form of a rectangular, plastic box which can be positioned either next to a computer or modem, or be installed in a switch cabinet (the latter solution is not recommended). The interface's function is to shape the Climatic's dialogue signals in order to make them compatible with the EIA RS232 standard. **It is absolutely essential to use the RS232 interface for all dialogues with a Climatic.** This constitutes electrical insulation between the Climatic's and the computer. Its current-loop type link between the interface and the Climatic's enables a dialogue over long distances (maximum of 1000 meters).

## Wiring principle

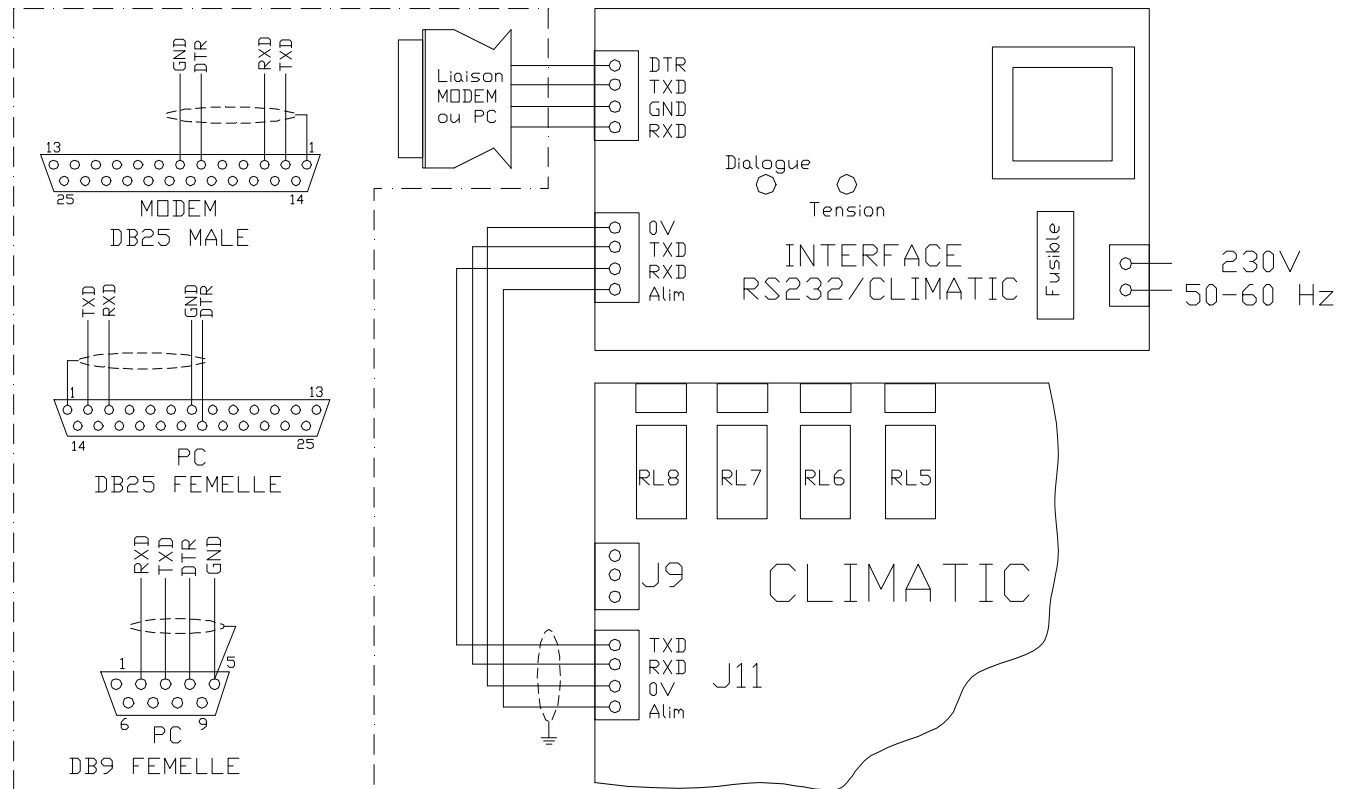

# ALPHANUMERICAL DISPLAY UNIT TECHNICAL DATA SHEET

## Key :

- 1 : Allocation of green LED's.
- 2 : Allocation of D1 to D6, C1 to C5 and S1 to S5 keys.
- 3 : «Voltage presence » yellow LED.
- 4 : «Unit ON» green LED (see allocation in 1)
- 5 : «Default presence » red LED.
- 6 : Digital display unit.
- 7 : Digital display unit which defines, by means of a message, the value shown on the digital display unit or an incident or an incident diagnosis.
- 8 : CLIMATIC function keys.

**H: Enables reading and setting of hours, minutes and day of the week.**

↳ *1<sup>st</sup> time pressed* : Reading of hours and minutes.

↳ *2<sup>nd</sup> time pressed* : Reading and modification of hours

↳ *3<sup>d</sup> time pressed* : Reading and modification of minutes

↳ *4<sup>th</sup> time pressed* : Reading and modification of the day.

- |              |             |
|--------------|-------------|
| 1: Sunday    | 5: Thursday |
| 2: Monday    | 6: Friday   |
| 3: Tuesday   | 7: Saturday |
| 4: Wednesday |             |

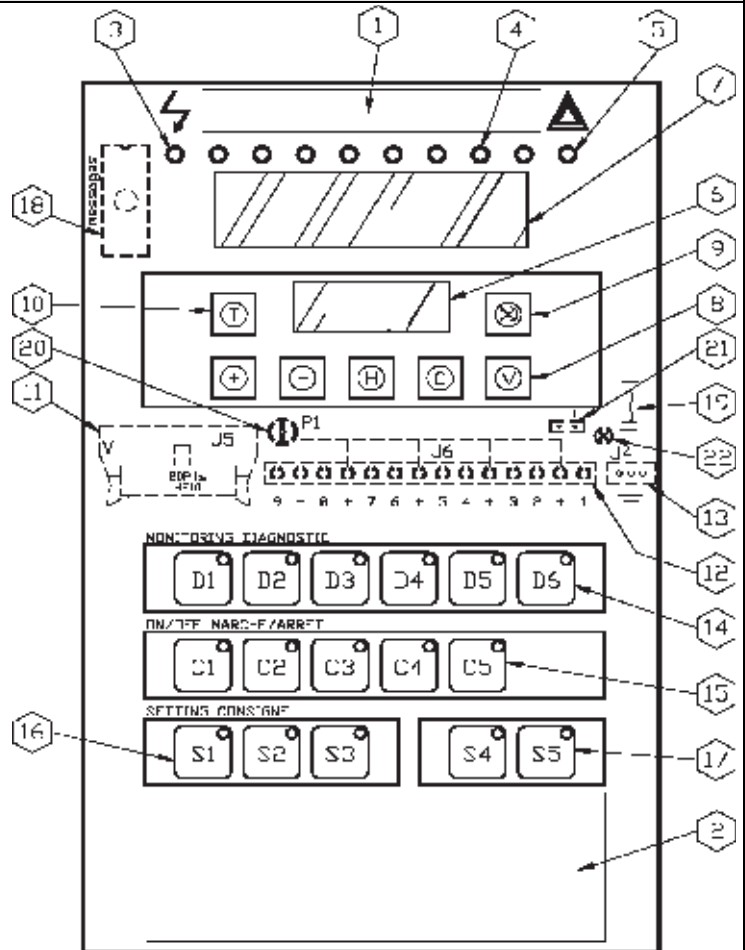

Modifications are carried out through means of the + and - keys.

### C: Enables access to setpoints.

When the key is pressed, the number of the setpoint (00 to 15) is displayed. Each time the C key is pressed, the following setpoint is scrolled up.

When the key is released, the setpoint value is displayed. This value can be modified, within the limits authorized by the CLIMATIC, through means of the + and - keys (see list of variables, "setpoints" paragraph).

### V: Enables reading of variables.

When the key is pressed, the address of the variable is displayed.

When the key is released, the value of the variable is displayed. The value of a variable cannot be modified. In order to change the address, use the + and - keys. Not all the variables used in a CLIMATIC program can be visualized on the display unit (see list of variables).

# ALPHANUMERICAL DISPLAY UNIT TECHNICAL DATA SHEET

- 9 : Clearance display unit buzzer (the buzzer is available as an option).
- 10: Change of language for messages shown on the alphanumerical display unit. French and English are included in the standard version.
- 11 20-pin connector to be connected to the CLIMATIC board at J13.
- 12: Nine potential free contacts used to control the eight green LED's, item 4, and red LED, item 5. The wiring is to be carried out with non-shielded wire.
- 13: 12VAC power-supply connector, for lighting on display units and the 10 LED's.
- 14: Six diagnosis keys enabling access to a description of the operating state of the machine, the circuits and compressors (see allocation in 2).
- 15: Five "On / Off" keys in the refrigerating circuit.
- 16: Three keys for visualizing the main control setpoints. These keys may sometimes be used for various other functions (see allocation in 2).
- 17: Two keys for various functions (see allocation in 2).
- 18: Eprom containing the messages and parameter settings for the keys (see mounting direction on drawing below).
- 19: 1A fuse, delayed-action, for protection of LED's and lighting on display units.
- 20: Contrast adjustment potentiometer on alphanumerical display unit.
- 21: Buzzer connection connector on rear panel.
- 22: CLIMATIC link presence LED.

## ② Replacement of an alphanumerical display unit

### Procedure to be followed :

- ☞ Cut off the power-supply to the CLIMATIC board and the display unit.
- ☞ Change the display unit.
- ☞ Recover the EPROM from the former display unit as well as the allocations of the LED'S and keys, item 1 and 2, and refit all items on the new display unit (see drawing below).
- ☞ Reconnect all connections on the display unit, referring to the wiring diagram.
- ☞ Power the board and display unit back up.

### EPROM mounting direction:

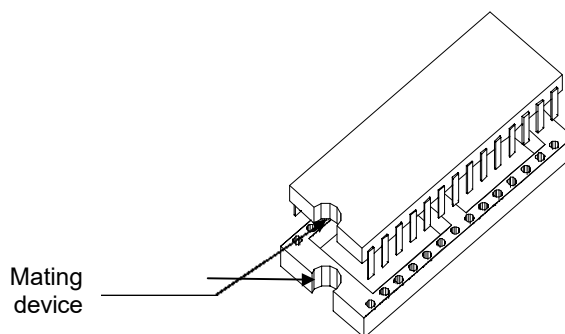

**Comment :** if there is no longer any display, it is necessary to check the CLIMATIC power-supply. The 12VAC power-supply source on the display unit is used only for the lighting on the LCD display units, and ten signaling LED's.



# ALPHANUMERICAL DISPLAY UNIT TECHNICAL DATA SHEET

## Ⓢ Modification of setpoints by indirect addressing

The CLIMATIC has only 16 setpoints which can be modified directly via the display unit; this may prove to be insufficient on certain machines. For this type of unit, in order to access additional setpoints, proceed as follows:

- Press key C until obtaining the "ADDRESS" setpoint (see list of variables, "setpoints" paragraph).
- Display the address of the variable to be modified (see list of the variables, "setpoints" paragraph).
- When the required address is displayed, press key C in order to obtain the "VALUE" setpoint
- Display the required value in U units (see conversion table).
- Press the Sx\* key on the alphanumerical display unit in order to validate your modification.

\* see allocation of keys on the alphanumerical display unit, item 2.

## Conversion table for "C", "M", "K", and "D" units into "U" units

Presentation of CLIMATIC units

Unit	Range	Step	Name
C	-28°C to 99.5°C	0.5	Temperature unit
M	-99.5°C to 28°C	0.5	Temperature unit
D	0 to 25.5	0.1	Pressure unit in bars
K	0 to 127.5	0.5	Temperature differential unit
L	0 or 1		Logic variable
U	0 to 255	1	Numerical variable without unit
N	0 to 255	1	Numerical variable without unit, invisible on display-unit

1: Conversion of "C" into "U" (range from -28°C to +99,5°C)

$$\text{Value in U} = (\text{Value}_C + 28) \cdot 2$$

2: Conversion of "M" into "U" (1M = 1°C, range from -99.5°C to +28°C)

$$\text{Value in U} = (\text{Value}_M \cdot 2) + 199$$

3: Conversion of "K" into "U" (1K = 1°C, range from 0K to 127.5K)

$$\text{Value in U} = (\text{Value}_K \cdot 2)$$

4: Conversion of "D" into "U" (range from 0 to 25.5)

$$\text{Value in U} = (\text{Value}_D \cdot 10)$$

# 24EL BOARD TECHNICAL DATA SHEET

The 24EL board provides the possibility of connecting 24 additional logic inputs to the CLIMATIC board. For each CLIMATIC board, there can be up to two 24EL boards, i.e., 48 additional logic inputs.

## Configuration of 24EL board

For each input, there are a maximum of 8 contacts.

if the inputs in the CLIMATIC are declared at the addresses:

170 to 172, jumper JP1 must be placed between 1 and 2 (default configuration)

173 to 175, jumper JP1 is placed between 2 and 3

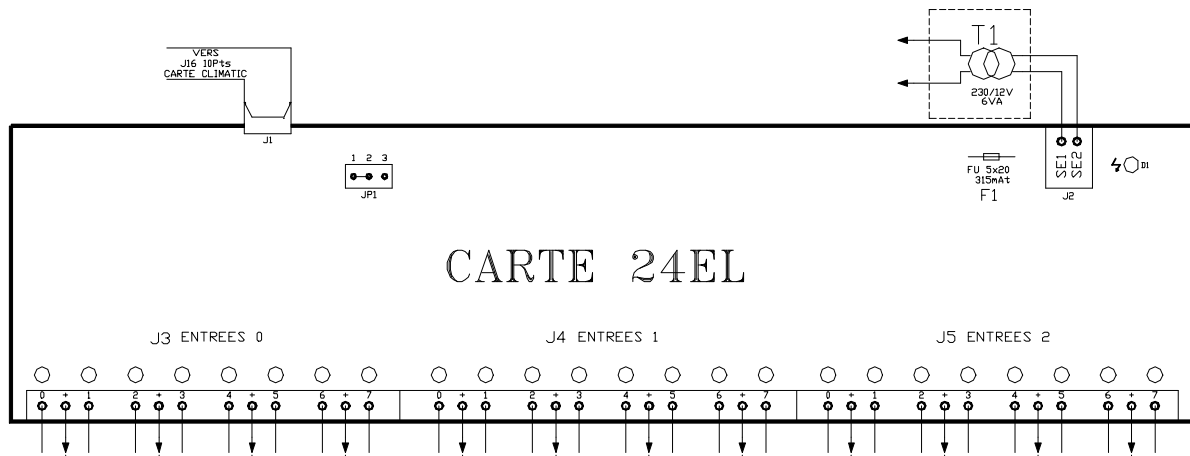

### **- Key:**

- J1: 10-pin HE connector for CLIMATIC link at J16
- J2: 12 V power-supply 2-pin connector
- J3: 12-pin connector for logic input connection on input 0
- J4: 12-pin connector for logic input connection on input 1
- J5: 12-pin connector for logic input connection on input 2
- JP1: jumper for logic input board 24 identification
- D1: voltage presence LED
- F1: 315 mA/T fuse

### Verification of a contact on an input:

- ☞ Check the electric power-supply of the board (fuse), D1 LED lit up.
- ☞ Check that the LED of the input to be checked is lit up.
- ☞ Go to the CLIMATIC address corresponding to the contact (see list of variables in enclosed documentation),

# 4/20mA BOARD TECHNICAL DATA SHEET

The 4/20mA board enables conversion of a 0/20mA signal into a signal which is proportional in voltage and which can be read by the CLIMATIC.

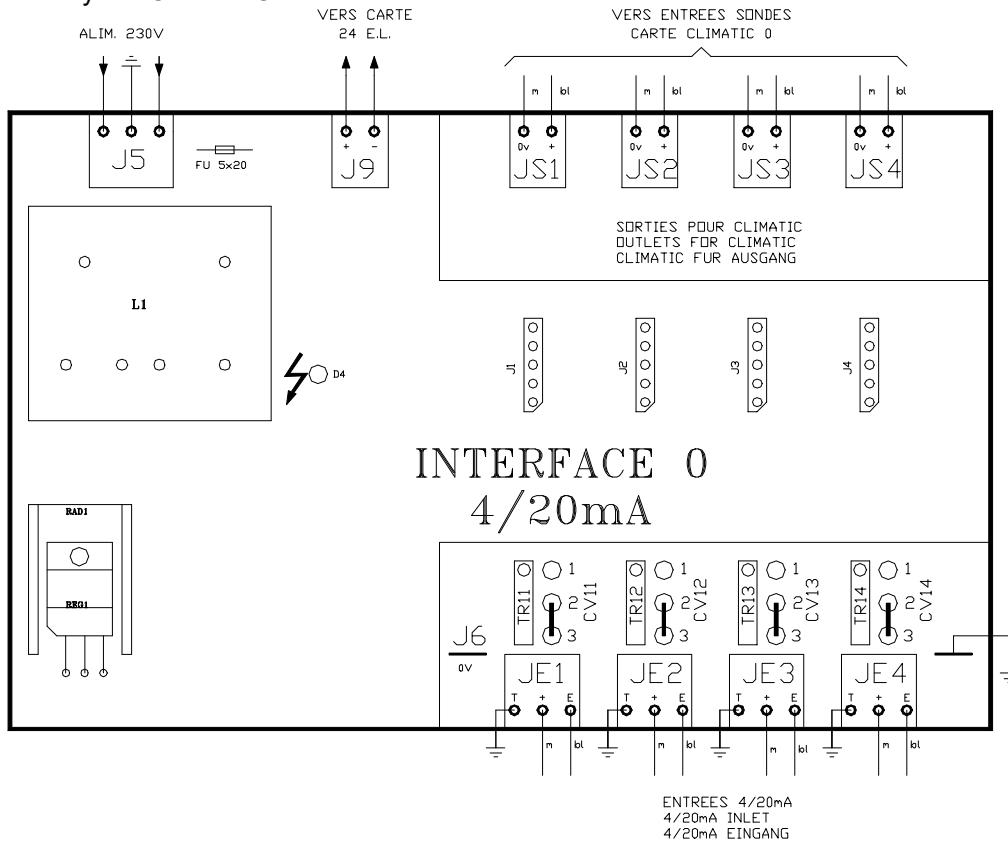

**- Key:**

- JE1 to JE4 : connector for sensor link
- T ⇨ earth
- + ⇨ 15V power-supply
- E ⇨ signal input
- J1 to J4 : 0/20 mA module
- CV11 to CV14 : calibration switch (calibration in position 1-2)
- TR11 to TR14 : calibration potentiometer
- JS1 to JS4 : connector for link on CLIMATIC sensor inputs
- FU : 5x20 100mA fuse
- J9 : voltage presence contact on 4/20 mA card
- D4 : voltage presence LED

It is possible to check the calibration of the 4/20mA board by placing the CV1n jumper on position 1-2 and by checking the value of the variable associated with the JEn input. The value read must be equal to 243. Calibration is carried out using the TR1n potentiometer. Only one input can be calibrated at a time (a single CV1n jumper in position 1-2). If the CLIMATIC board or the 4/20mA board is changed, it is absolutely essential to check its calibration.

Absence of electric power-supply causes an alarm on the CLIMATIC. The default is detected by an input on the 24EL board, which is connected to the voltage presence contact on board 4/20mA (see section on power default on board 4/20mA).

# 8RS2ST RELAY EXTENSION BOARD TECHNICAL DATA SHEET

The 8RS2ST board includes 8 relays, two of which can be replaced by static relays. It is possible to put up to three 8RS2ST boards in tandem, i.e., 24 relays altogether.

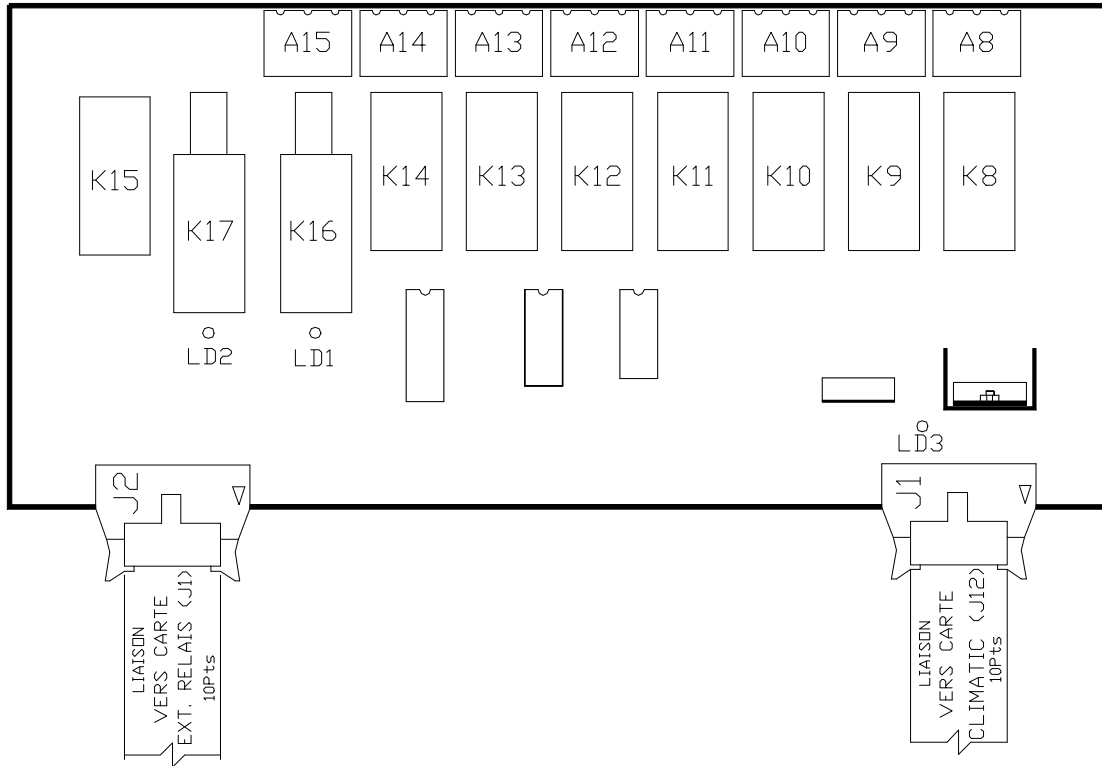

**- Key:**

- K8 to K15 : relay
- K16 and K17 : static relay
- LD1 and LD2 : static relay status LED
- A8 to A15 : actuator outlet connectors
- LD3 : voltage presence LED
- J1 and J2 : connectors for linking cards together and with the CLIMATIC

**COMMENT:**

When installing an 8RS2ST board, if the CLIMATIC board is not referenced 4770008V, **it is absolutely essential to cut off wire N°9 on the 10-pin ribbon cable, in order not to damage the boards.**

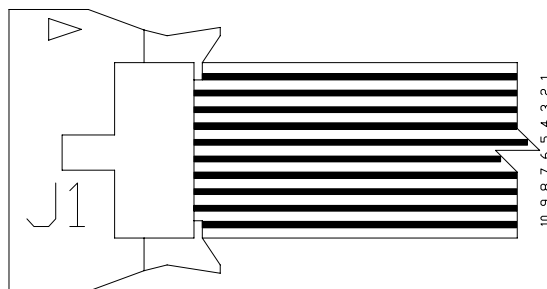

# 8RS2ANA RELAY EXTENSION BOARD TECHNICAL DATA SHEET

The 8RS2ANA board includes 8 relays and two 0/10V analog outputs. Its connection is similar to the 8RS2ST board, except for the fact that it uses a 12VAC power-supply. It is possible to put it in tandem with an 8RS2ST board, i.e., 16 relays and one analog output altogether.

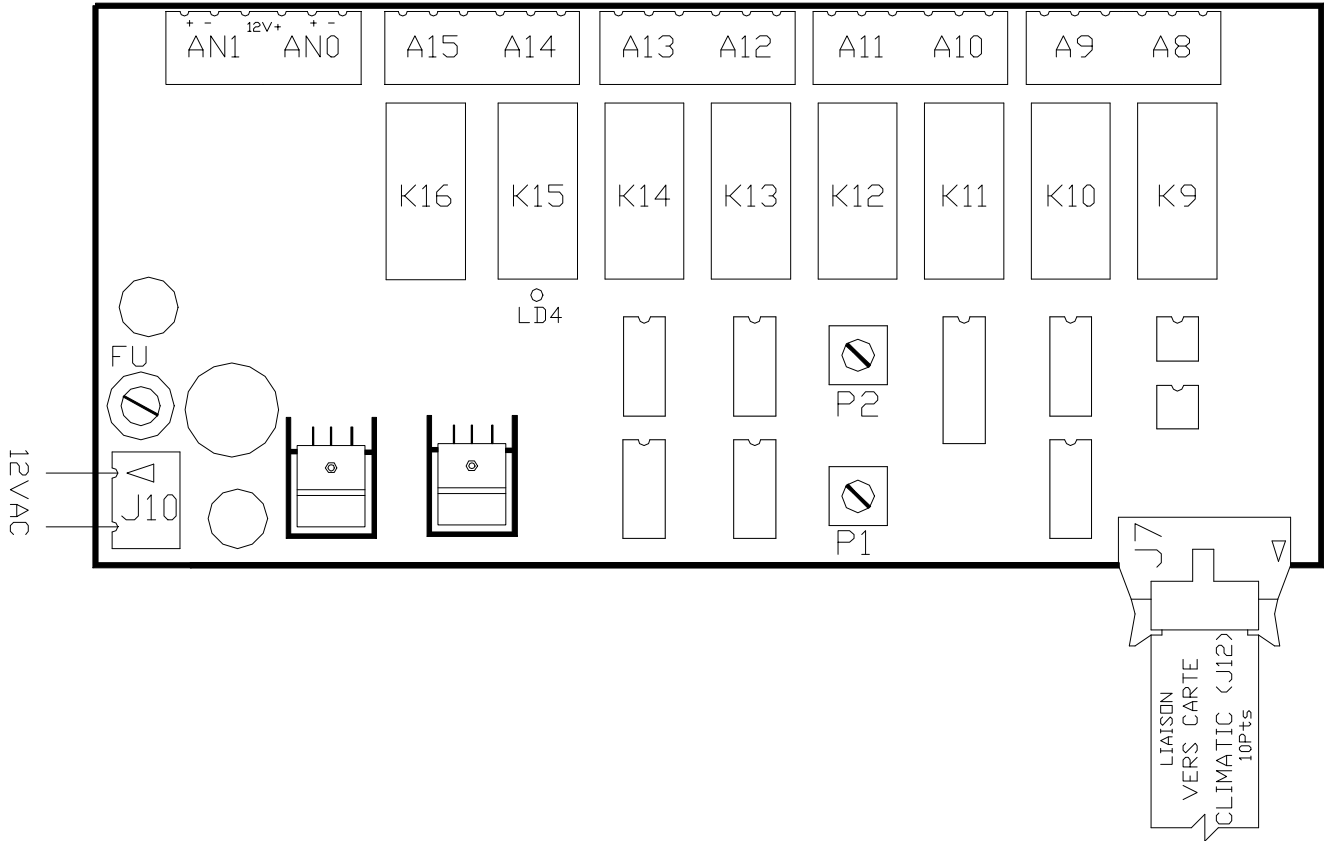

**- Key:**

- K9 to K16 :relay
- A8 to A15 :actuator output connectors
- AN0 and AN1 :analog outputs (0/10V)
- P1 and P2 :calibration potentiometer for analog outputs
- FU :5x20 1A/T fuse
- LD4 :voltage presence LED
- J7 :connectors for linking between the card and CLIMATIC

# CLIMATIC SENSOR TECHNICAL DATA SHEET

The standard CLIMATIC sensors are thermistors. The graph below represents the progression of the resistive value of the sensor according to temperature. For a single temperature, the values of the resistors of a round sensor and a flat sensor are identical.

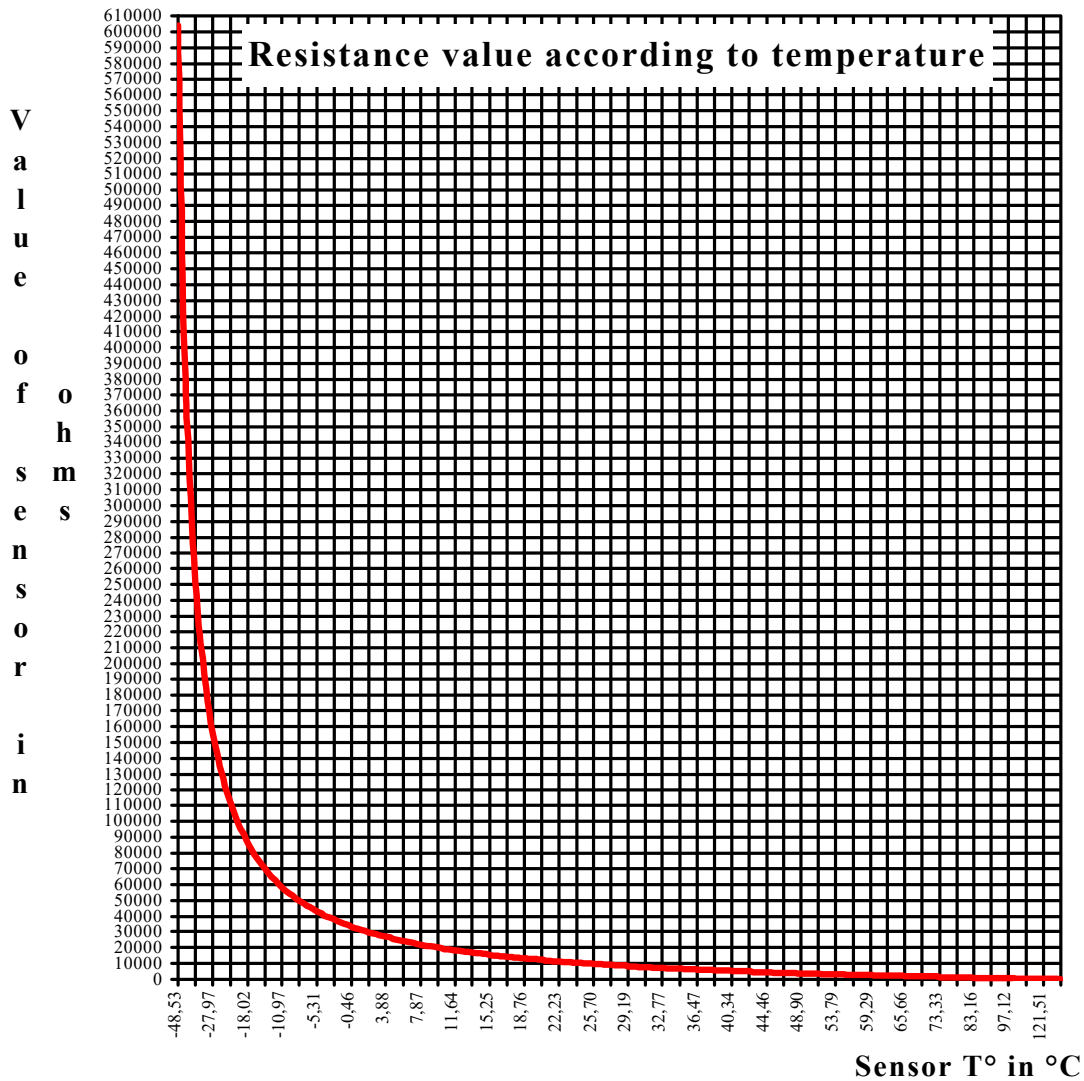

The CLIMATIC enables direct visualisation, in °C, at addresses 0 to 15, temperatures which may vary from -28°C to +99.5°C, (see list of variables for the sensor addresses). For a temperature higher than 99.5°C, the corresponding variable declared in °C stays blocked on the 99.5°C maximum value. Only the variable in U, whose address is between 16 and 31, is then significant. The table below gives the U/°C equivalencies for temperatures exceeding 99.°C.

# CLIMATIC SENSOR TECHNICAL DATA SHEET

U	°C
242	101
243	103
244	105
245	107
246	109.5
247	112
248	115

U	°C
249	118
250	121.5
251	125.5
252	129.5
253	134.5
254	140
255	146.5

## **Verification of a sensor :**

Select the address of the sensor to be verified (see use on the display unit)

- ☞ The displayed value is equal to 99.5°C.  
The sensor is in short-circuit or it measures a temperature higher than 99.5°C (see equivalency table).  
Should the sensor be in short-circuit, it must be replaced.
- ☞ The displayed value is equal to -28°C.  
The sensor is cut off or disconnected. In the first case, the sensor must be replaced.
- ☞ The displayed value is between -28°C and 99.5°C.  
Check that the value displayed on the CLIMATIC corresponds to the actual temperature of the place where the sensor is positioned. If there is drift, check that the sensor is in proper contact with the piping or that it is not influenced by the sun. In the opposite case, the sensor is defective and must be replaced.

# SETPOINT VIA 4/20mA SIGNAL

## TECHNICAL DATA SHEET

The table below illustrates the °C value of the remote setpoint according to the value of the customer's 4/20mA signal.

°C value	4/20mA signal	°C value	4/20mA signal	°C value	4/20mA signal	°C value	4/20mA signal	°C value	4/20mA signal
-30	4	-9.5	7.215686	11	10.43137	31.5	13.64706	52	16.86275
-29.5	4.078431	-9	7.294117	11.5	10.5098	32	13.72549	52.5	16.94118
-29	4.156862	-8.5	7.372549	12	10.58823	32.5	13.80392	53	17.01961
-28.5	4.235294	-8	7.45098	12.5	10.66667	33	13.88235	53.5	17.09804
-28	4.313725	-7.5	7.529411	13	10.7451	33.5	13.96078	54	17.17647
-27.5	4.392157	-7	7.607843	13.5	10.82353	34	14.03922	54.5	17.2549
-27	4.470588	-6.5	7.686274	14	10.90196	34.5	14.11765	55	17.33333
-26.5	4.549019	-6	7.764706	14.5	10.98039	35	14.19608	55.5	17.41176
-26	4.62745	-5.5	7.843137	15	11.05882	35.5	14.27451	56	17.4902
-25.5	4.705882	-5	7.921568	15.5	11.13725	36	14.35294	56.5	17.56863
-25	4.784313	-4.5	8	16	11.21569	36.5	14.43137	57	17.64706
-24.5	4.862745	-4	8.078431	16.5	11.29412	37	14.5098	57.5	17.72549
-24	4.941176	-3.5	8.156862	17	11.37255	37.5	14.58823	58	17.80392
-23.5	5.019608	-3	8.235293	17.5	11.45098	38	14.66667	58.5	17.88235
-23	5.098039	-2.5	8.313725	18	11.52941	38.5	14.7451	59	17.96078
-22.5	5.17647	-2	8.392157	18.5	11.60784	39	14.82353	59.5	18.03922
-22	5.254901	-1.5	8.470588	19	11.68627	39.5	14.90196	60	18.11765
-21.5	5.333333	-1	8.549019	19.5	11.76471	40	14.98039	60.5	18.19608
-21	5.411764	-.5	8.627451	20	11.84314	40.5	15.05882	61	18.27451
-20.5	5.490196	0	8.705882	20.5	11.92157	41	15.13725	61.5	18.35294
-20	5.568627	.5	8.784313	21	12	41.5	15.21569	62	18.43137
-19.5	5.647058	1	8.862745	21.5	12.07843	42	15.29412	62.5	18.5098
-19	5.72549	1.5	8.941176	22	12.15686	42.5	15.37255	63	18.58824
-18.5	5.803921	2	9.019608	22.5	12.23529	43	15.45098	63.5	18.66667
-18	5.882352	2.5	9.098039	23	12.31373	43.5	15.52941	64	18.7451
-17.5	5.960784	3	9.176471	23.5	12.39216	44	15.60784	64.5	18.82353
-17	6.039215	3.5	9.254902	24	12.47059	44.5	15.68627	65	18.90196
-16.5	6.117647	4	9.333333	24.5	12.54902	45	15.76471	65.5	18.98039
-16	6.196078	4.5	9.411764	25	12.62745	45.5	15.84314	66	19.05882
-15.5	6.274509	5	9.490196	25.5	12.70588	46	15.92157	66.5	19.13725
-15	6.352941	5.5	9.568627	26	12.78431	46.5	16	67	19.21569
-14.5	6.431372	6	9.647058	26.5	12.86275	47	16.07843	67.5	19.29412
-14	6.509804	6.5	9.72549	27	12.94118	47.5	16.15686	68	19.37255
-13.5	6.588235	7	9.803922	27.5	13.01961	48	16.23529	68.5	19.45098
-13	6.666667	7.5	9.882353	28	13.09804	48.5	16.31373	69	19.52941
-12.5	6.745098	8	9.960784	28.5	13.17647	49	16.39216	69.5	19.60784
-12	6.823529	8.5	10.03922	29	13.2549	49.5	16.47059	70	19.68628
-11.5	6.90196	9	10.11765	29.5	13.33333	50	16.54902	70.5	19.76471
-11	6.980392	9.5	10.19608	30	13.41176	50.5	16.62745	71	19.84314
-10.5	7.058823	10	10.27451	30.5	13.4902	51	16.70588	71.5	19.92157
-10	7.137255	10.5	10.35294	31	13.56863	51.5	16.78431	72	20

The remote setpoint value cannot be greater or less than the CLIMATIC's internal setpoint (see list of variables, "setpoints" paragraph).



# SETPOINT VIA 4/20mA SIGNAL

## TECHNICAL DATA SHEET

The table below illustrates the °C value of the remote setpoint according to the value of the customer's 4/20mA signal.

°C value	4/20mA signal
4	4
4.5	4.5
5	5
5.5	5.5
6	6
6.5	6.5
7	7
7.5	7.5
8	8
8.5	8.5
9	9
9.5	9.5
10	10
10.5	10.5
11	11
11.5	11.5
12	12
12.5	12.5
13	13
13.5	13.5
14	14
14.5	14.5
15	15
15.5	15.5
16	16
16.5	16.5
17	17
17.5	17.5
18	18
18.5	18.5
19	19
19.5	19.5
20	20

The remote setpoint cannot be greater than or less than the CLIMATIC's internal setpoint (see list of variables, "setpoints" paragraph).

# CONVERSION TABLE - 0/7 BAR R22 SENSOR

## TECHNICAL DATA SHEET

U VALUE	PRESSURE in bars	TEMP. °C
52	0.034	-93.8252
53	0.069	-85.4088
54	0.103	-80.0192
55	0.137	-75.9604
56	0.172	-72.6667
57	0.206	-69.8752
58	0.240	-67.4409
59	0.275	-65.2749
60	0.309	-63.3186
61	0.343	-61.5309
62	0.377	-59.8822
63	0.412	-58.3502
64	0.446	-56.9176
65	0.480	-55.5709
66	0.515	-54.2992
67	0.549	-53.0937
68	0.583	-51.9469
69	0.618	-50.8527
70	0.652	-49.8059
71	0.686	-48.8021
72	0.721	-47.8374
73	0.755	-46.9086
74	0.789	-46.0126
75	0.824	-45.1469
76	0.858	-44.3094
77	0.892	-43.4979
78	0.926	-42.7107
79	0.961	-41.9462
80	0.995	-41.2029
81	1.029	-40.4796
82	1.064	-39.7750
83	1.098	-39.0880
84	1.132	-38.4177
85	1.167	-37.7631
86	1.201	-37.1235
87	1.235	-36.4981
88	1.270	-35.8861
89	1.304	-35.2869
90	1.338	-34.7000
91	1.373	-34.1247
92	1.407	-33.5605
93	1.441	-33.0070
94	1.475	-32.4636
95	1.510	-31.9301
96	1.544	-31.4059
97	1.578	-30.8907
98	1.613	-30.3841
99	1.647	-29.8859
100	1.681	-29.3956
101	1.716	-28.9131
102	1.750	-28.4380
103	1.784	-27.9701

U VALUE	PRESSURE in bars	TEMP. °C
104	1.819	-27.5092
105	1.853	-27.0549
106	1.887	-26.6071
107	1.922	-26.1656
108	1.956	-25.7301
109	1.990	-25.3005
110	2.025	-24.8766
111	2.059	-24.4582
112	2.093	-24.0452
113	2.127	-23.6374
114	2.162	-23.2346
115	2.196	-22.8367
116	2.230	-22.4436
117	2.265	-22.0552
118	2.299	-21.6712
119	2.333	-21.2917
120	2.368	-20.9164
121	2.402	-20.5453
122	2.436	-20.1782
123	2.471	-19.8151
124	2.505	-19.4559
125	2.539	-19.1004
126	2.574	-18.7486
127	2.608	-18.4004
128	2.642	-18.0557
129	2.676	-17.7144
130	2.711	-17.3764
131	2.745	-17.0417
132	2.779	-16.7102
133	2.814	-16.3819
134	2.848	-16.0565
135	2.882	-15.7342
136	2.917	-15.4148
137	2.951	-15.0983
138	2.985	-14.7846
139	3.020	-14.4736
140	3.054	-14.1653
141	3.088	-13.8597
142	3.123	-13.5566
143	3.157	-13.2561
144	3.191	-12.9580
145	3.225	-12.6624
146	3.260	-12.3692
147	3.294	-12.0783
148	3.328	-11.7898
149	3.363	-11.5035
150	3.397	-11.2194
151	3.431	-10.9375
152	3.466	-10.6577
153	3.500	-10.3801
154	3.534	-10.1045
155	3.569	-9.8309

# CONVERSION TABLE - 0/7 BAR R22 SENSOR TECHNICAL DATA SHEET

U VALUE	PRESSURE in bars	TEMP. °C
156	3.603	-9.5593
157	3.637	-9.2897
158	3.672	-9.0221
159	3.706	-8.7563
160	3.740	-8.4924
161	3.775	-8.2303
162	3.809	-7.9700
163	3.843	-7.7115
164	3.877	-7.4548
165	3.912	-7.1997
166	3.946	-6.9464
167	3.980	-6.6947
168	4.015	-6.4447
169	4.049	-6.1963
170	4.083	-5.9495
171	4.118	-5.7042
172	4.152	-5.4605
173	4.186	-5.2183
174	4.221	-4.9777
175	4.255	-4.7385
176	4.289	-4.5007
177	4.324	-4.2644
178	4.358	-4.0295
179	4.392	-3.7960
180	4.426	-3.5639
181	4.461	-3.3331
182	4.495	-3.1037
183	4.529	-2.8756
184	4.564	-2.6488
185	4.598	-2.4233
186	4.632	-2.1991
187	4.667	-1.9761
188	4.701	-1.7543
189	4.735	-1.5338
190	4.770	-1.3145
191	4.804	-1.0963
192	4.838	-0.8793
193	4.873	-0.6635
194	4.907	-0.4489
195	4.941	-0.2353
196	4.975	-0.0229
197	5.010	0.1884
198	5.044	0.3986
199	5.078	0.6078
200	5.113	0.8159
201	5.147	1.0229
202	5.181	1.2289
203	5.216	1.4339
204	5.250	1.6379
205	5.284	1.8408

U VALUE	PRESSURE in bars	TEMP. °C
206	5.319	2.0428
207	5.353	2.2438
208	5.387	2.4438
209	5.422	2.6429
210	5.456	2.8410
211	5.490	3.0382
212	5.525	3.2344
213	5.559	3.4298
214	5.593	3.6242
215	5.627	3.8178
216	5.662	4.0104
217	5.696	4.2022
218	5.730	4.3931
219	5.765	4.5832
220	5.799	4.7724
221	5.833	4.9608
222	5.868	5.1483
223	5.902	5.3351
224	5.936	5.5210
225	5.971	5.7061
226	6.005	5.8904
227	6.039	6.0739
228	6.074	6.2566
229	6.108	6.4386
230	6.142	6.6198
231	6.176	6.8002
232	6.211	6.9799
233	6.245	7.1589
234	6.279	7.3371
235	6.314	7.5146
236	6.348	7.6913
237	6.382	7.8674
238	6.417	8.0427
239	6.451	8.2174
240	6.485	8.3913
241	6.520	8.5646
242	6.554	8.7372
243	6.588	8.9091
244	6.623	9.0803
245	6.657	9.2509
246	6.691	9.4208
247	6.725	9.5900
248	6.760	9.7586
249	6.794	9.9266
250	6.828	10.0940
251	6.863	10.2607
252	6.897	10.4268
253	6.931	10.5923
254	6.966	10.7571
255	7.000	10.9214

# CONVERSION TABLE - 0/25 BAR R22 SENSOR TECHNICAL DATA SHEET

U VALUE	PRESSURE in bars	TEMP. °C
52	0.123	-77.5838
53	0.245	-67.1167
54	0.368	-60.3405
55	0.490	-55.2004
56	0.613	-51.0060
57	0.735	-47.4351
58	0.858	-44.3094
59	0.980	-41.5190
60	1.103	-38.9912
61	1.225	-36.6754
62	1.348	-34.5344
63	1.471	-32.5407
64	1.593	-30.6725
65	1.716	-28.9131
66	1.838	-27.2488
67	1.961	-25.6684
68	2.083	-24.1627
69	2.206	-22.7239
70	2.328	-21.3456
71	2.451	-20.0221
72	2.574	-18.7486
73	2.696	-17.5208
74	2.819	-16.3352
75	2.941	-15.1884
76	3.064	-14.0777
77	3.186	-13.0004
78	3.309	-11.9544
79	3.431	-10.9375
80	3.554	-9.9479
81	3.676	-8.9840
82	3.799	-8.0442
83	3.922	-7.1272
84	4.044	-6.2317
85	4.167	-5.3565
86	4.289	-4.5007
87	4.412	-3.6632
88	4.534	-2.8431
89	4.657	-2.0397
90	4.779	-1.2520
91	4.902	-0.4795
92	5.025	0.2786
93	5.147	1.0229
94	5.270	1.7540
95	5.392	2.4723
96	5.515	3.1785
97	5.637	3.8729
98	5.760	4.5561
99	5.882	5.2285
100	6.005	5.8904
101	6.127	6.5422
102	6.250	7.1844
103	6.373	7.8172

U VALUE	PRESSURE in bars	TEMP. °C
104	6.495	8.4409
105	6.618	9.0559
106	6.740	9.6624
107	6.863	10.2607
108	6.985	10.8511
109	7.108	11.4338
110	7.230	12.0090
111	7.353	12.5770
112	7.475	13.1379
113	7.598	13.6921
114	7.721	14.2396
115	7.843	14.7807
116	7.966	15.3155
117	8.088	15.8442
118	8.211	16.3670
119	8.333	16.8841
120	8.456	17.3955
121	8.578	17.9014
122	8.701	18.4019
123	8.824	18.8973
124	8.946	19.3875
125	9.069	19.8728
126	9.191	20.3533
127	9.314	20.8290
128	9.436	21.3001
129	9.559	21.7667
130	9.681	22.2289
131	9.804	22.6867
132	9.926	23.1404
133	10.049	23.5899
134	10.172	24.0353
135	10.294	24.4768
136	10.417	24.9144
137	10.539	25.3483
138	10.662	25.7784
139	10.784	26.2048
140	10.907	26.6277
141	11.029	27.0471
142	11.152	27.4631
143	11.275	27.8757
144	11.397	28.2850
145	11.520	28.6911
146	11.642	29.0940
147	11.765	29.4937
148	11.887	29.8904
149	12.010	30.2841
150	12.132	30.6748
151	12.255	31.0627
152	12.377	31.4476
153	12.500	31.8298
154	12.623	32.2092
155	12.745	32.5859

# CONVERSION TABLE - 0/25 BAR R22 SENSOR

## TECHNICAL DATA SHEET

U VALUE	PRESSURE in bars	TEMP. °C
156	12.868	32.9600
157	12.990	33.3314
158	13.113	33.7003
159	13.235	34.0666
160	13.358	34.4304
161	13.480	34.7918
162	13.603	35.1507
163	13.725	35.5073
164	13.848	35.8616
165	13.971	36.2135
166	14.093	36.5632
167	14.216	36.9106
168	14.338	37.2559
169	14.461	37.5989
170	14.583	37.9399
171	14.706	38.2787
172	14.828	38.6155
173	14.951	38.9502
174	15.074	39.2829
175	15.196	39.6136
176	15.319	39.9423
177	15.441	40.2691
178	15.564	40.5941
179	15.686	40.9171
180	15.809	41.2383
181	15.931	41.5576
182	16.054	41.8752
183	16.176	42.1910
184	16.299	42.5050
185	16.422	42.8172
186	16.544	43.1278
187	16.667	43.4367
188	16.789	43.7439
189	16.912	44.0494
190	17.034	44.3534
191	17.157	44.6557
192	17.279	44.9564
193	17.402	45.2556
194	17.525	45.5532
195	17.647	45.8493
196	17.770	46.1439
197	17.892	46.4370
198	18.015	46.7286
199	18.137	47.0187
200	18.260	47.3074
201	18.382	47.5947
202	18.505	47.8806
203	18.627	48.1651
204	18.750	48.4482
205	18.873	48.7299

U VALUE	PRESSURE in bars	TEMP. °C
206	18.995	49.0103
207	19.118	49.2894
208	19.240	49.5671
209	19.363	49.8436
210	19.485	50.1188
211	19.608	50.3926
212	19.730	50.6653
213	19.853	50.9366
214	19.975	51.2068
215	20.098	51.4757
216	20.221	51.7434
217	20.343	52.0099
218	20.466	52.2752
219	20.588	52.5394
220	20.711	52.8024
221	20.833	53.0642
222	20.956	53.3250
223	21.078	53.5846
224	21.201	53.8430
225	21.324	54.1004
226	21.446	54.3567
227	21.569	54.6119
228	21.691	54.8660
229	21.814	55.1191
230	21.936	55.3711
231	22.059	55.6221
232	22.181	55.8720
233	22.304	56.1209
234	22.426	56.3688
235	22.549	56.6157
236	22.672	56.8616
237	22.794	57.1066
238	22.917	57.3505
239	23.039	57.5935
240	23.162	57.8355
241	23.284	58.0766
242	23.407	58.3168
243	23.529	58.5560
244	23.652	58.7942
245	23.775	59.0316
246	23.897	59.2681
247	24.020	59.5036
248	24.142	59.7383
249	24.265	59.9721
250	24.387	60.2050
251	24.510	60.4370
252	24.632	60.6682
253	24.755	60.8985
254	24.877	61.1279
255	25.000	61.3566

# CONVERSION TABLE - 0/7 BAR R134A SENSOR TECHNICAL DATA SHEET

U VALUE	PRESSURE in bars	TEMP. °C
52	0.034	-80.6587
53	0.069	-72.0057
54	0.103	-66.4700
55	0.137	-62.3031
56	0.172	-58.9225
57	0.206	-56.0576
58	0.240	-53.5595
59	0.275	-51.3368
60	0.309	-49.3292
61	0.343	-47.4947
62	0.377	-45.8027
63	0.412	-44.2303
64	0.446	-42.7600
65	0.480	-41.3777
66	0.515	-40.0723
67	0.549	-38.8347
68	0.583	-37.6574
69	0.618	-36.5340
70	0.652	-35.4592
71	0.686	-34.4285
72	0.721	-33.4379
73	0.755	-32.4840
74	0.789	-31.5638
75	0.824	-30.6747
76	0.858	-29.8144
77	0.892	-28.9809
78	0.926	-28.1723
79	0.961	-27.3869
80	0.995	-26.6233
81	1.029	-25.8802
82	1.064	-25.1562
83	1.098	-24.4504
84	1.132	-23.7616
85	1.167	-23.0891
86	1.201	-22.4318
87	1.235	-21.7891
88	1.270	-21.1602
89	1.304	-20.5444
90	1.338	-19.9412
91	1.373	-19.3499
92	1.407	-18.7701
93	1.441	-18.2012
94	1.475	-17.6427
95	1.510	-17.0943
96	1.544	-16.5555
97	1.578	-16.0259
98	1.613	-15.5052
99	1.647	-14.9930
100	1.681	-14.4891
101	1.716	-13.9931
102	1.750	-13.5047
103	1.784	-13.0237

U VALUE	PRESSURE in bars	TEMP. °C
104	1.819	-12.5498
105	1.853	-12.0828
106	1.887	-11.6225
107	1.922	-11.1686
108	1.956	-10.7209
109	1.990	-10.2793
110	2.025	-9.8435
111	2.059	-9.4134
112	2.093	-8.9888
113	2.127	-8.5695
114	2.162	-8.1555
115	2.196	-7.7465
116	2.230	-7.3423
117	2.265	-6.9430
118	2.299	-6.5483
119	2.333	-6.1581
120	2.368	-5.7723
121	2.402	-5.3908
122	2.436	-5.0135
123	2.471	-4.6402
124	2.505	-4.2710
125	2.539	-3.9055
126	2.574	-3.5439
127	2.608	-3.1860
128	2.642	-2.8317
129	2.676	-2.4808
130	2.711	-2.1335
131	2.745	-1.7895
132	2.779	-1.4488
133	2.814	-1.1113
134	2.848	-0.7769
135	2.882	-0.4456
136	2.917	-0.1174
137	2.951	0.2079
138	2.985	0.5303
139	3.020	0.8499
140	3.054	1.1667
141	3.088	1.4808
142	3.123	1.7922
143	3.157	2.1010
144	3.191	2.4073
145	3.225	2.7110
146	3.260	3.0123
147	3.294	3.3111
148	3.328	3.6076
149	3.363	3.9018
150	3.397	4.1936
151	3.431	4.4832
152	3.466	4.7706
153	3.500	5.0558
154	3.534	5.3389
155	3.569	5.6199

# CONVERSION TABLE - 0/7 BAR R134a SENSOR

## TECHNICAL DATA SHEET

U VALUE	PRESSURE in bars	TEMP. °C
156	3.603	5.8988
157	3.637	6.1758
158	3.672	6.4507
159	3.706	6.7236
160	3.740	6.9947
161	3.775	7.2638
162	3.809	7.5311
163	3.843	7.7965
164	3.877	8.0602
165	3.912	8.3220
166	3.946	8.5822
167	3.980	8.8405
168	4.015	9.0972
169	4.049	9.3523
170	4.083	9.6056
171	4.118	9.8574
172	4.152	10.1076
173	4.186	10.3561
174	4.221	10.6032
175	4.255	10.8487
176	4.289	11.0927
177	4.324	11.3352
178	4.358	11.5763
179	4.392	11.8159
180	4.426	12.0540
181	4.461	12.2908
182	4.495	12.5262
183	4.529	12.7603
184	4.564	12.9929
185	4.598	13.2243
186	4.632	13.4543
187	4.667	13.6831
188	4.701	13.9105
189	4.735	14.1367
190	4.770	14.3617
191	4.804	14.5854
192	4.838	14.8079
193	4.873	15.0292
194	4.907	15.2493
195	4.941	15.4683
196	4.975	15.6861
197	5.010	15.9027
198	5.044	16.1183
199	5.078	16.3327
200	5.113	16.5460
201	5.147	16.7582
202	5.181	16.9694
203	5.216	17.1795
204	5.250	17.3885
205	5.284	17.5965

U VALUE	PRESSURE in bars	TEMP. °C
206	5.319	17.8035
207	5.353	18.0094
208	5.387	18.2144
209	5.422	18.4184
210	5.456	18.6213
211	5.490	18.8234
212	5.525	19.0244
213	5.559	19.2245
214	5.593	19.4237
215	5.627	19.6219
216	5.662	19.8192
217	5.696	20.0157
218	5.730	20.2112
219	5.765	20.4058
220	5.799	20.5996
221	5.833	20.7924
222	5.868	20.9844
223	5.902	21.1756
224	5.936	21.3659
225	5.971	21.5554
226	6.005	21.7441
227	6.039	21.9319
228	6.074	22.1189
229	6.108	22.3051
230	6.142	22.4906
231	6.176	22.6752
232	6.211	22.8591
233	6.245	23.0422
234	6.279	23.2245
235	6.314	23.4061
236	6.348	23.5869
237	6.382	23.7670
238	6.417	23.9463
239	6.451	24.1250
240	6.485	24.3028
241	6.520	24.4800
242	6.554	24.6565
243	6.588	24.8323
244	6.623	25.0074
245	6.657	25.1817
246	6.691	25.3554
247	6.725	25.5285
248	6.760	25.7008
249	6.794	25.8725
250	6.828	26.0436
251	6.863	26.2140
252	6.897	26.3837
253	6.931	26.5528
254	6.966	26.7212
255	7.000	26.8891

# CONVERSION TABLE - 0/25 BAR R134a SENSOR TECHNICAL DATA SHEET

U VALUE	PRESSURE in bars	TEMP. °C
52	0.123	-63.9696
53	0.245	-53.2268
54	0.368	-46.2730
55	0.490	-40.9973
56	0.613	-36.6914
57	0.735	-33.0247
58	0.858	-29.8144
59	0.980	-26.9480
60	1.103	-24.3510
61	1.225	-21.9713
62	1.348	-19.7711
63	1.471	-17.7219
64	1.593	-15.8017
65	1.716	-13.9931
66	1.838	-12.2822
67	1.961	-10.6575
68	2.083	-9.1096
69	2.206	-7.6305
70	2.328	-6.2136
71	2.451	-4.8530
72	2.574	-3.5439
73	2.696	-2.2819
74	2.819	-1.0633
75	2.941	0.1153
76	3.064	1.2567
77	3.186	2.3637
78	3.309	3.4385
79	3.431	4.4832
80	3.554	5.4997
81	3.676	6.4898
82	3.799	7.4549
83	3.922	8.3965
84	4.044	9.3159
85	4.167	10.2143
86	4.289	11.0927
87	4.412	11.9521
88	4.534	12.7936
89	4.657	13.6178
90	4.779	14.4257
91	4.902	15.2180
92	5.025	15.9952
93	5.147	16.7582
94	5.270	17.5075
95	5.392	18.2436
96	5.515	18.9671
97	5.637	19.6784
98	5.760	20.3781
99	5.882	21.0665
100	6.005	21.7441
101	6.127	22.4112
102	6.250	23.0683
103	6.373	23.7156

U VALUE	PRESSURE in bars	TEMP. °C
104	6.495	24.3535
105	6.618	24.9824
106	6.740	25.6024
107	6.863	26.2140
108	6.985	26.8172
109	7.108	27.4125
110	7.230	28
111	7.353	28.5800
112	7.475	29.1527
113	7.598	29.7183
114	7.721	30.2770
115	7.843	30.8290
116	7.966	31.3744
117	8.088	31.9135
118	8.211	32.4464
119	8.333	32.9734
120	8.456	33.4944
121	8.578	34.0097
122	8.701	34.5195
123	8.824	35.0238
124	8.946	35.5228
125	9.069	36.0167
126	9.191	36.5055
127	9.314	36.9893
128	9.436	37.4683
129	9.559	37.9426
130	9.681	38.4123
131	9.804	38.8775
132	9.926	39.3383
133	10.049	39.7947
134	10.172	40.2470
135	10.294	40.6951
136	10.417	41.1391
137	10.539	41.5792
138	10.662	42.0154
139	10.784	42.4478
140	10.907	42.8765
141	11.029	43.3015
142	11.152	43.7229
143	11.275	44.1408
144	11.397	44.5552
145	11.520	44.9663
146	11.642	45.3740
147	11.765	45.7785
148	11.887	46.1797
149	12.010	46.5778
150	12.132	46.9728
151	12.255	47.3648
152	12.377	47.7538
153	12.500	48.1399
154	12.623	48.5230
155	12.745	48.9034



# CONVERSION TABLE - 0/25 BAR R134a SENSOR TECHNICAL DATA SHEET

U VALUE	PRESSURE in bars	TEMP. °C
156	12.868	49.2809
157	12.990	49.6557
158	13.113	50.0278
159	13.235	50.3973
160	13.358	50.7641
161	13.480	51.1284
162	13.603	51.4901
163	13.725	51.8494
164	13.848	52.2062
165	13.971	52.5606
166	14.093	52.9126
167	14.216	53.2623
168	14.338	53.6097
169	14.461	53.9548
170	14.583	54.2976
171	14.706	54.6383
172	14.828	54.9768
173	14.951	55.3131
174	15.074	55.6474
175	15.196	55.9795
176	15.319	56.3096
177	15.441	56.6377
178	15.564	56.9638
179	15.686	57.2879
180	15.809	57.6100
181	15.931	57.9303
182	16.054	58.2487
183	16.176	58.5652
184	16.299	58.8798
185	16.422	59.1927
186	16.544	59.5037
187	16.667	59.8130
188	16.789	60.1205
189	16.912	60.4263
190	17.034	60.7304
191	17.157	61.0328
192	17.279	61.3336
193	17.402	61.6327
194	17.525	61.9302
195	17.647	62.2261
196	17.770	62.5204
197	17.892	62.8131
198	18.015	63.1043
199	18.137	63.3940
200	18.260	63.6821
201	18.382	63.9688
202	18.505	64.2540
203	18.627	64.5377
204	18.750	64.8200
205	18.873	65.1009

U VALUE	PRESSURE in bars	TEMP. °C
206	18.995	65.3804
207	19.118	65.6584
208	19.240	65.9351
209	19.363	66.2104
210	19.485	66.4844
211	19.608	66.7571
212	19.730	67.0284
213	19.853	67.2984
214	19.975	67.5672
215	20.098	67.8346
216	20.221	68.1008
217	20.343	68.3658
218	20.466	68.6295
219	20.588	68.8920
220	20.711	69.1533
221	20.833	69.4133
222	20.956	69.6722
223	21.078	69.9300
224	21.201	70.1865
225	21.324	70.4419
226	21.446	70.6962
227	21.569	70.9493
228	21.691	71.2013
229	21.814	71.4522
230	21.936	71.7021
231	22.059	71.9508
232	22.181	72.1984
233	22.304	72.4450
234	22.426	72.6906
235	22.549	72.9351
236	22.672	73.1785
237	22.794	73.4210
238	22.917	73.6624
239	23.039	73.9028
240	23.162	74.1422
241	23.284	74.3806
242	23.407	74.6181
243	23.529	74.8546
244	23.652	75.0901
245	23.775	75.3247
246	23.897	75.5583
247	24.020	75.7910
248	24.142	76.0227
249	24.265	76.2536
250	24.387	76.4835
251	24.510	76.7125
252	24.632	76.9407
253	24.755	77.1679
254	24.877	77.3943
255	25.000	77.6197

# CONVERSION TABLE - 0/7 BAR R407C SENSOR TECHNICAL DATA SHEET

U VALUE	PRESSURE in bars	PHASE	TEMP. °C
58	0.240	liquid	-70.452
		vapor	-62.585
59	0.275	liquid	-68.342
		vapor	-60.432
60	0.309	liquid	-66.442
		vapor	-58.499
61	0.343	liquid	-64.102
		vapor	-56.741
62	0.377	liquid	-62.465
		vapor	-55.115
63	0.412	liquid	-60.948
		vapor	-53.599
64	0.446	liquid	-59.443
		vapor	-52.192
65	0.480	liquid	-58.109
		vapor	-50.874
66	0.515	liquid	-56.851
		vapor	-49.622
67	0.549	liquid	-55.653
		vapor	-48.441
68	0.583	liquid	-54.510
		vapor	-47.314
69	0.618	liquid	-53.434
		vapor	-46.243
70	0.652	liquid	-52.396
		vapor	-45.222
71	0.686	liquid	-51.407
		vapor	-44.238
72	0.720	liquid	-50.457
		vapor	-43.293
73	0.755	liquid	-49.539
		vapor	-42.387
74	0.789	liquid	-48.655
		vapor	-41.514
75	0.824	liquid	-47.798
		vapor	-40.668
76	0.858	liquid	-46.974
		vapor	-39.852
77	0.892	liquid	-46.175
		vapor	-39.064
78	0.927	liquid	-45.397
		vapor	-38.295
79	0.961	liquid	-44.645
		vapor	-37.520
80	0.995	liquid	-43.939
		vapor	-36.801
81	1.029	liquid	-43.228
		vapor	-36.097
82	1.064	liquid	-42.533
		vapor	-35.416
83	1.098	liquid	-41.857
		vapor	-34.749

U VALUE	PRESSURE in bars	PHASE	TEMP. °C
84	1.132	liquid	-41.195
		vapor	-34.098
85	1.167	liquid	-40.552
		vapor	-33.463
86	1.201	liquid	-39.923
		vapor	-32.845
87	1.235	liquid	-39.308
		vapor	-32.238
88	1.270	liquid	-38.707
		vapor	-31.645
89	1.304	liquid	-38.119
		vapor	-31.066
90	1.338	liquid	-37.542
		vapor	-30.497
91	1.372	liquid	-36.976
		vapor	-29.940
92	1.407	liquid	-36.422
		vapor	-29.396
93	1.441	liquid	-35.878
		vapor	-28.857
94	1.476	liquid	-35.342
		vapor	-28.333
95	1.510	liquid	-34.818
		vapor	-27.816
96	1.544	liquid	-34.301
		vapor	-27.311
97	1.578	liquid	-33.796
		vapor	-26.814
98	1.613	liquid	-33.296
		vapor	-26.325
99	1.647	liquid	-32.807
		vapor	-25.844
100	1.681	liquid	-32.324
		vapor	-25.369
101	1.716	liquid	-31.851
		vapor	-24.905
102	1.750	liquid	-31.384
		vapor	-24.446
103	1.784	liquid	-30.923
		vapor	-23.996
104	1.819	liquid	-30.470
		vapor	-23.551
105	1.853	liquid	-30.025
		vapor	-23.113
106	1.887	liquid	-29.585
		vapor	-22.680
107	1.922	liquid	-29.151
		vapor	-22.256
108	1.956	liquid	-28.723
		vapor	-21.837
109	1.990	liquid	-28.300
		vapor	-21.422

# CONVERSION TABLE - 0/7 BAR R407C SENSOR TECHNICAL DATA SHEET

U VALUE	PRESSURE in bars	PHASE	TEMP. °C
110	2.024	liquid	-27.885
		vapor	-21.015
111	2.059	liquid	-27.473
		vapor	-20.612
112	2.093	liquid	-27.068
		vapor	-20.214
113	2.127	liquid	-26.668
		vapor	-19.821
114	2.162	liquid	-26.274
		vapor	-19.434
115	2.196	liquid	-25.886
		vapor	-19.051
116	2.230	liquid	-25.501
		vapor	-18.673
117	2.265	liquid	-25.119
		vapor	-18.300
118	2.299	liquid	-24.744
		vapor	-17.930
119	2.333	liquid	-24.372
		vapor	-17.565
120	2.368	liquid	-24.006
		vapor	-17.204
121	2.402	liquid	-23.642
		vapor	-16.847
122	2.436	liquid	-23.283
		vapor	-16.495
123	2.471	liquid	-22.928
		vapor	-16.146
124	2.505	liquid	-22.576
		vapor	-15.800
125	2.539	liquid	-22.229
		vapor	-15.460
126	2.574	liquid	-21.884
		vapor	-15.122
127	2.608	liquid	-21.543
		vapor	-14.787
128	2.642	liquid	-21.207
		vapor	-14.456
129	2.676	liquid	-20.873
		vapor	-14.128
130	2.711	liquid	-20.544
		vapor	-13.803
131	2.745	liquid	-20.215
		vapor	-13.482
132	2.779	liquid	-19.891
		vapor	-13.165
133	2.814	liquid	-19.571
		vapor	-12.850
134	2.848	liquid	-19.253
		vapor	-12.537
135	2.882	liquid	-18.937
		vapor	-12.228

U VALUE	PRESSURE in bars	PHASE	TEMP. °C
136	2.917	liquid	-18.625
		vapor	-11.922
137	2.951	liquid	-18.316
		vapor	-11.619
138	2.985	liquid	-18.008
		vapor	-11.318
139	3.020	liquid	-17.705
		vapor	-11.020
140	3.054	liquid	-17.404
		vapor	-10.724
141	3.088	liquid	-17.105
		vapor	-10.432
142	3.123	liquid	-16.810
		vapor	-10.142
143	3.157	liquid	-16.516
		vapor	-9.854
144	3.191	liquid	-16.225
		vapor	-9.568
145	3.225	liquid	-15.936
		vapor	-9.285
146	3.260	liquid	-15.649
		vapor	-9.005
147	3.294	liquid	-15.365
		vapor	-8.728
148	3.328	liquid	-15.083
		vapor	-8.450
149	3.363	liquid	-14.803
		vapor	-8.177
150	3.397	liquid	-14.526
		vapor	-7.905
151	3.431	liquid	-14.251
		vapor	-7.636
152	3.466	liquid	-13.978
		vapor	-7.368
153	3.500	liquid	-13.707
		vapor	-7.103
154	3.534	liquid	-13.438
		vapor	-6.839
155	3.569	liquid	-13.170
		vapor	-6.579
156	3.603	liquid	-12.905
		vapor	-6.319
157	3.637	liquid	-12.642
		vapor	-6.061
158	3.672	liquid	-12.381
		vapor	-5.805
159	3.706	liquid	-12.121
		vapor	-5.551
160	3.740	liquid	-11.864
		vapor	-5.299
161	3.774	liquid	-11.609
		vapor	-5.049

# CONVERSION TABLE - 0/7 BAR R407C SENSOR

## TECHNICAL DATA SHEET

U VALUE	PRESSURE in bars	PHASE	TEMP. °C
162	3.809	liquid	-11.353
		vapor	-4.800
163	3.843	liquid	-11.102
		vapor	-4.553
164	3.878	liquid	-10.851
		vapor	-4.308
165	3.912	liquid	-10.602
		vapor	-4.065
166	3.946	liquid	-10.355
		vapor	-3.822
167	3.980	liquid	-10.111
		vapor	-3.583
168	4.015	liquid	-9.866
		vapor	-3.344
169	4.049	liquid	-9.624
		vapor	-3.107
170	4.083	liquid	-9.383
		vapor	-2.872
171	4.118	liquid	-9.144
		vapor	-2.637
172	4.152	liquid	-8.906
		vapor	-2.405
173	4.186	liquid	-8.670
		vapor	-2.174
174	4.221	liquid	-8.435
		vapor	-1.945
175	4.255	liquid	-8.202
		vapor	-1.717
176	4.289	liquid	-7.971
		vapor	-1.490
177	4.324	liquid	-7.740
		vapor	-1.265
178	4.358	liquid	-7.511
		vapor	-1.041
179	4.392	liquid	-7.283
		vapor	-.818
180	4.426	liquid	-7.058
		vapor	-.596
181	4.461	liquid	-6.833
		vapor	-.377
182	4.495	liquid	-6.609
		vapor	-.158
183	4.529	liquid	-6.386
		vapor	.059
184	4.564	liquid	-6.165
		vapor	.275
185	4.598	liquid	-5.945
		vapor	.490
186	4.632	liquid	-5.727
		vapor	.703
187	4.667	liquid	-5.510
		vapor	.916

U VALUE	PRESSURE in bars	PHASE	TEMP. °C
188	4.701	liquid	-5.293
		vapor	1.127
189	4.735	liquid	-5.079
		vapor	1.337
190	4.770	liquid	-4.865
		vapor	1.546
191	4.804	liquid	-4.652
		vapor	1.753
192	4.838	liquid	-4.441
		vapor	1.959
193	4.873	liquid	-4.230
		vapor	2.165
194	4.907	liquid	-4.021
		vapor	2.370
195	4.941	liquid	-3.814
		vapor	2.573
196	4.975	liquid	-3.607
		vapor	2.775
197	5.010	liquid	-3.401
		vapor	2.975
198	5.044	liquid	-3.196
		vapor	3.176
199	5.078	liquid	-2.993
		vapor	3.375
200	5.113	liquid	-2.790
		vapor	3.573
201	5.147	liquid	-2.588
		vapor	3.769
202	5.181	liquid	-2.387
		vapor	3.966
203	5.216	liquid	-2.188
		vapor	4.160
204	5.250	liquid	-1.989
		vapor	4.354
205	5.284	liquid	-1.791
		vapor	4.547
206	5.319	liquid	-1.595
		vapor	4.739
207	5.353	liquid	-1.399
		vapor	4.930
208	5.387	liquid	-1.205
		vapor	5.120
209	5.422	liquid	-1.011
		vapor	5.309
210	5.456	liquid	-.818
		vapor	5.497
211	5.490	liquid	-.625
		vapor	5.685
212	5.525	liquid	-.434
		vapor	5.871
213	5.559	liquid	-.245
		vapor	6.056

Reference: RFL - V1.0 - 97

# CONVERSION TABLE - 0/7 BAR R407C SENSOR

## TECHNICAL DATA SHEET

U VALUE	PRESSURE in bars	PHASE	TEMP. °C
214	5.593	liquid	-.055
		vapor	6.241
215	5.627	liquid	.133
		vapor	6.425
216	5.662	liquid	.321
		vapor	6.608
217	5.696	liquid	.508
		vapor	6.790
218	5.730	liquid	.693
		vapor	6.971
219	5.765	liquid	.878
		vapor	7.152
220	5.799	liquid	1.062
		vapor	7.332
221	5.833	liquid	1.246
		vapor	7.510
222	5.868	liquid	1.428
		vapor	7.688
223	5.902	liquid	1.610
		vapor	7.865
224	5.936	liquid	1.791
		vapor	8.042
225	5.971	liquid	1.972
		vapor	8.217
226	6.005	liquid	2.150
		vapor	8.392
227	6.039	liquid	2.329
		vapor	8.566
228	6.074	liquid	2.507
		vapor	8.739
229	6.108	liquid	2.684
		vapor	8.912
230	6.142	liquid	2.860
		vapor	9.084
231	6.176	liquid	3.036
		vapor	9.255
232	6.211	liquid	3.210
		vapor	9.425
233	6.245	liquid	3.385
		vapor	9.595
234	6.279	liquid	3.558
		vapor	9.764

U VALUE	PRESSURE in bars	PHASE	TEMP. °C
235	6.314	liquid	3.731
		vapor	9.932
236	6.348	liquid	3.902
		vapor	10.099
237	6.382	liquid	4.074
		vapor	10.266
238	6.417	liquid	4.244
		vapor	10.432
239	6.451	liquid	4.415
		vapor	10.597
240	6.485	liquid	4.584
		vapor	10.762
241	6.520	liquid	4.753
		vapor	10.927
242	6.554	liquid	4.920
		vapor	11.090
243	6.588	liquid	5.087
		vapor	11.253
244	6.623	liquid	5.254
		vapor	11.415
245	6.657	liquid	5.420
		vapor	11.576
246	6.691	liquid	5.585
		vapor	11.737
247	6.726	liquid	5.750
		vapor	11.898
248	6.760	liquid	5.913
		vapor	12.057
249	6.794	liquid	6.076
		vapor	12.216
250	6.829	liquid	6.240
		vapor	12.374
251	6.863	liquid	6.402
		vapor	12.532
252	6.897	liquid	6.562
		vapor	12.689
253	6.931	liquid	6.724
		vapor	12.846
254	6.966	liquid	6.884
		vapor	13.002
255	7.000	liquid	7.044
		vapor	13.157

# CONVERSION TABLE - 0/25 BAR R407C SENSOR TECHNICAL DATA SHEET

U VALUE	PRESSURE in bars	PHASE	TEMP. °C
53	0.245	liquid	-70.144
		vapor	-62.256
54	0.368	liquid	-62.915
		vapor	-55.565
55	0.490	liquid	-57.740
		vapor	-50.506
56	0.613	liquid	-53.582
		vapor	-46.392
57	0.735	liquid	-50.056
		vapor	-42.901
58	0.858	liquid	-46.974
		vapor	-39.852
59	0.980	liquid	-44.249
		vapor	-37.105
60	1.103	liquid	-41.761
		vapor	-34.653
61	1.226	liquid	-39.481
		vapor	-32.409
62	1.348	liquid	-37.377
		vapor	-30.335
63	1.471	liquid	-35.419
		vapor	-28.407
64	1.593	liquid	-33.582
		vapor	-26.602
65	1.716	liquid	-31.851
		vapor	-24.905
66	1.838	liquid	-30.214
		vapor	-23.301
67	1.961	liquid	-28.662
		vapor	-21.777
68	2.083	liquid	-27.183
		vapor	-20.327
69	2.206	liquid	-25.774
		vapor	-18.942
70	2.329	liquid	-24.424
		vapor	-17.617
71	2.451	liquid	-23.131
		vapor	-16.344
72	2.574	liquid	-21.884
		vapor	-15.122
73	2.696	liquid	-20.684
		vapor	-13.943
74	2.819	liquid	-19.525
		vapor	-12.805
75	2.941	liquid	-18.404
		vapor	-11.705
76	3.064	liquid	-17.319
		vapor	-10.641
77	3.186	liquid	-16.266
		vapor	-9.609
78	3.309	liquid	-15.244
		vapor	-8.608

U VALUE	PRESSURE in bars	PHASE	TEMP. °C
79	3.431	liquid	-14.251
		vapor	-7.636
80	3.554	liquid	-13.284
		vapor	-6.690
81	3.677	liquid	-12.344
		vapor	-5.768
82	3.799	liquid	-11.426
		vapor	-4.872
83	3.922	liquid	-10.532
		vapor	-3.995
84	4.044	liquid	-9.659
		vapor	-3.141
85	4.167	liquid	-8.805
		vapor	-2.306
86	4.289	liquid	-7.971
		vapor	-1.490
87	4.412	liquid	-7.154
		vapor	-.691
88	4.534	liquid	-6.355
		vapor	.090
89	4.657	liquid	-5.572
		vapor	.855
90	4.779	liquid	-4.804
		vapor	1.605
91	4.902	liquid	-4.052
		vapor	2.340
92	5.025	liquid	-3.313
		vapor	3.062
93	5.147	liquid	-2.588
		vapor	3.769
94	5.270	liquid	-1.876
		vapor	4.464
95	5.392	liquid	-1.177
		vapor	5.147
96	5.515	liquid	-.489
		vapor	5.818
97	5.637	liquid	.187
		vapor	6.477
98	5.760	liquid	.852
		vapor	7.126
99	5.882	liquid	1.506
		vapor	7.764
100	6.005	liquid	2.150
		vapor	8.392
101	6.127	liquid	2.785
		vapor	9.010
102	6.250	liquid	3.409
		vapor	9.619
103	6.372	liquid	4.025
		vapor	10.218
104	6.495	liquid	4.632
		vapor	10.809

# CONVERSION TABLE - 0/25 BAR R407C SENSOR

## TECHNICAL DATA SHEET

U VALUE	PRESSURE in bars	PHASE	TEMP. °C
105	6.618	liquid	5.230
		vapor	11.392
106	6.740	liquid	5.820
		vapor	11.966
107	6.863	liquid	6.402
		vapor	12.532
108	6.985	liquid	6.976
		vapor	13.091
109	7.108	liquid	7.542
		vapor	13.642
110	7.230	liquid	8.101
		vapor	14.186
111	7.353	liquid	8.653
		vapor	14.723
112	7.476	liquid	9.199
		vapor	15.253
113	7.598	liquid	9.739
		vapor	15.777
114	7.721	liquid	10.271
		vapor	16.294
115	7.843	liquid	10.797
		vapor	16.805
116	7.966	liquid	11.316
		vapor	17.309
117	8.088	liquid	11.830
		vapor	17.808
118	8.211	liquid	12.338
		vapor	18.301
119	8.333	liquid	12.840
		vapor	18.788
120	8.456	liquid	13.337
		vapor	19.270
121	8.578	liquid	13.828
		vapor	19.747
122	8.701	liquid	14.314
		vapor	20.219
123	8.823	liquid	14.795
		vapor	20.685
124	8.946	liquid	15.271
		vapor	21.147
125	9.069	liquid	15.742
		vapor	21.603
126	9.191	liquid	16.208
		vapor	22.056
127	9.314	liquid	16.670
		vapor	22.503
128	9.436	liquid	17.127
		vapor	22.946
129	9.559	liquid	17.580
		vapor	23.385
130	9.681	liquid	18.029
		vapor	23.819

U VALUE	PRESSURE in bars	PHASE	TEMP. °C
131	9.804	liquid	18.473
		vapor	24.249
132	9.926	liquid	18.913
		vapor	24.676
133	10.049	liquid	19.349
		vapor	25.098
134	10.171	liquid	19.781
		vapor	25.516
135	10.294	liquid	20.210
		vapor	25.930
136	10.417	liquid	20.635
		vapor	26.341
137	10.539	liquid	21.055
		vapor	26.748
138	10.662	liquid	21.472
		vapor	27.151
139	10.784	liquid	21.886
		vapor	27.551
140	10.907	liquid	22.296
		vapor	27.947
141	11.029	liquid	22.703
		vapor	28.340
142	11.152	liquid	23.106
		vapor	28.730
143	11.274	liquid	23.506
		vapor	29.116
144	11.397	liquid	23.903
		vapor	29.500
145	11.520	liquid	24.296
		vapor	29.880
146	11.642	liquid	24.687
		vapor	30.257
147	11.765	liquid	25.075
		vapor	30.631
148	11.887	liquid	25.460
		vapor	31.002
149	12.010	liquid	25.841
		vapor	31.370
150	12.132	liquid	26.220
		vapor	31.735
151	12.255	liquid	26.596
		vapor	32.097
152	12.377	liquid	26.969
		vapor	32.457
153	12.500	liquid	27.339
		vapor	32.814
154	12.623	liquid	27.707
		vapor	33.169
155	12.745	liquid	28.072
		vapor	33.520
156	12.868	liquid	28.435
		vapor	33.869

# CONVERSION TABLE - 0/25 BAR R407C SENSOR

## TECHNICAL DATA SHEET

U VALUE	PRESSURE in bars	PHASE	TEMP. °C
157	12.990	liquid	28.795
		vapor	34.216
158	13.113	liquid	29.152
		vapor	34.560
159	13.235	liquid	29.507
		vapor	34.902
160	13.358	liquid	29.860
		vapor	35.241
161	13.480	liquid	30.210
		vapor	35.577
162	13.603	liquid	30.558
		vapor	35.912
163	13.726	liquid	30.903
		vapor	36.244
164	13.848	liquid	31.246
		vapor	36.574
165	13.971	liquid	31.587
		vapor	36.902
166	14.093	liquid	31.926
		vapor	37.227
167	14.216	liquid	32.263
		vapor	37.551
168	14.338	liquid	32.597
		vapor	37.872
169	14.461	liquid	32.930
		vapor	38.191
170	14.583	liquid	33.260
		vapor	38.509
171	14.706	liquid	33.588
		vapor	38.824
172	14.828	liquid	33.914
		vapor	39.137
173	14.951	liquid	34.238
		vapor	39.448
174	15.074	liquid	34.561
		vapor	39.757
175	15.196	liquid	34.881
		vapor	40.064
176	15.319	liquid	35.200
		vapor	40.369
177	15.441	liquid	35.516
		vapor	40.673
178	15.564	liquid	35.831
		vapor	40.974
179	15.686	liquid	36.144
		vapor	41.274
180	15.809	liquid	36.455
		vapor	41.572
181	15.931	liquid	36.765
		vapor	41.869
182	16.054	liquid	37.072
		vapor	42.163

U VALUE	PRESSURE in bars	PHASE	TEMP. °C
183	16.176	liquid	37.378
		vapor	42.456
184	16.299	liquid	37.682
		vapor	42.747
185	16.422	liquid	37.985
		vapor	43.036
186	16.544	liquid	38.286
		vapor	43.324
187	16.667	liquid	38.585
		vapor	43.610
188	16.789	liquid	38.883
		vapor	43.895
189	16.912	liquid	39.179
		vapor	44.178
190	17.034	liquid	39.473
		vapor	44.459
191	17.157	liquid	39.766
		vapor	44.739
192	17.279	liquid	40.057
		vapor	45.017
193	17.402	liquid	40.347
		vapor	45.294
194	17.524	liquid	40.635
		vapor	45.569
195	17.647	liquid	40.922
		vapor	45.843
196	17.770	liquid	41.208
		vapor	46.116
197	17.892	liquid	41.491
		vapor	46.387
198	18.015	liquid	41.774
		vapor	46.656
199	18.137	liquid	42.055
		vapor	46.924
200	18.260	liquid	42.335
		vapor	47.191
201	18.382	liquid	42.613
		vapor	47.456
202	18.505	liquid	42.891
		vapor	47.720
203	18.627	liquid	43.166
		vapor	47.983
204	18.750	liquid	43.441
		vapor	48.244
205	18.872	liquid	43.713
		vapor	48.504
206	18.995	liquid	43.985
		vapor	48.763
207	19.118	liquid	44.256
		vapor	49.020
208	19.240	liquid	44.525
		vapor	49.276



# CONVERSION TABLE - 0/25 BAR R407C SENSOR TECHNICAL DATA SHEET

U VALUE	PRESSURE in bars	PHASE	TEMP. °C
209	19.363	liquid	44.793
		vapor	49.531
210	19.485	liquid	45.060
		vapor	49.785
211	19.608	liquid	45.325
		vapor	50.037
212	19.730	liquid	45.590
		vapor	50.288
213	19.853	liquid	45.853
		vapor	50.538
214	19.976	liquid	46.115
		vapor	50.787
215	20.098	liquid	46.375
		vapor	51.035
216	20.221	liquid	46.635
		vapor	51.281
217	20.343	liquid	46.893
		vapor	51.526
218	20.466	liquid	47.151
		vapor	51.771
219	20.588	liquid	47.407
		vapor	52.014
220	20.711	liquid	47.662
		vapor	52.256
221	20.833	liquid	47.916
		vapor	52.496
222	20.956	liquid	48.169
		vapor	52.736
223	21.078	liquid	48.421
		vapor	52.975
224	21.201	liquid	48.671
		vapor	53.212
225	21.323	liquid	48.921
		vapor	53.449
226	21.446	liquid	49.170
		vapor	53.684
227	21.569	liquid	49.417
		vapor	53.919
228	21.691	liquid	49.664
		vapor	54.152
229	21.814	liquid	49.910
		vapor	54.384
230	21.936	liquid	50.154
		vapor	54.616
231	22.059	liquid	50.398
		vapor	54.846
232	22.181	liquid	50.640
		vapor	55.075

U VALUE	PRESSURE in bars	PHASE	TEMP. °C
233	22.304	liquid	50.882
		vapor	55.304
234	22.426	liquid	51.123
		vapor	55.531
235	22.549	liquid	51.363
		vapor	55.758
236	22.672	liquid	51.601
		vapor	55.983
237	22.794	liquid	51.839
		vapor	56.207
238	22.917	liquid	52.076
		vapor	56.431
239	23.039	liquid	52.312
		vapor	56.654
240	23.162	liquid	52.547
		vapor	56.875
241	23.284	liquid	52.782
		vapor	57.096
242	23.407	liquid	53.015
		vapor	57.316
243	23.529	liquid	53.247
		vapor	57.535
244	23.652	liquid	53.479
		vapor	57.753
245	23.775	liquid	53.710
		vapor	57.970
246	23.897	liquid	53.939
		vapor	58.187
247	24.020	liquid	54.168
		vapor	58.402
248	24.142	liquid	54.397
		vapor	58.617
249	24.265	liquid	54.624
		vapor	58.831
250	24.387	liquid	54.851
		vapor	59.044
251	24.510	liquid	55.076
		vapor	59.256
252	24.632	liquid	55.301
		vapor	59.467
253	24.755	liquid	55.525
		vapor	59.677
254	24.877	liquid	55.748
		vapor	59.887
255	25.000	liquid	55.970
		vapor	60.096

# CONVERSION TABLE - 0/7 BAR R404A SENSOR TECHNICAL DATA SHEET

U VALUE	PRESSURE in bars	PHASE	TEMP. °C
54	0.103	liquid	-84.901
		vapor	-83.974
55	0.137	liquid	-80.909
		vapor	-80.001
56	0.171	liquid	-77.673
		vapor	-76.784
57	0.206	liquid	-74.930
		vapor	-74.059
58	0.240	liquid	-72.536
		vapor	-71.685
59	0.275	liquid	-70.408
		vapor	-69.575
60	0.309	liquid	-68.497
		vapor	-67.664
61	0.343	liquid	-66.737
		vapor	-65.923
62	0.377	liquid	-65.129
		vapor	-64.315
63	0.412	liquid	-63.625
		vapor	-62.820
64	0.446	liquid	-62.224
		vapor	-61.420
65	0.480	liquid	-60.900
		vapor	-60.110
66	0.515	liquid	-59.656
		vapor	-58.871
67	0.549	liquid	-58.478
		vapor	-57.698
68	0.583	liquid	-57.352
		vapor	-56.577
69	0.618	liquid	-56.283
		vapor	-55.512
70	0.652	liquid	-55.257
		vapor	-54.495
71	0.686	liquid	-54.278
		vapor	-53.516
72	0.720	liquid	-53.332
		vapor	-52.575
73	0.755	liquid	-52.423
		vapor	-51.671
74	0.789	liquid	-51.544
		vapor	-50.801
75	0.824	liquid	-50.697
		vapor	-49.954
76	0.858	liquid	-49.879
		vapor	-49.141
77	0.892	liquid	-49.084
		vapor	-48.351
78	0.927	liquid	-48.313
		vapor	-47.584
79	0.961	liquid	-47.565
		vapor	-46.842

U VALUE	PRESSURE in bars	PHASE	TEMP. °C
80	0.995	liquid	-46.837
		vapor	-46.116
81	1.029	liquid	-46.132
		vapor	-45.413
82	1.064	liquid	-45.442
		vapor	-44.727
83	1.098	liquid	-44.770
		vapor	-44.056
84	1.132	liquid	-44.112
		vapor	-43.403
85	1.167	liquid	-43.474
		vapor	-42.767
86	1.201	liquid	-42.847
		vapor	-42.145
87	1.235	liquid	-42.234
		vapor	-41.534
88	1.270	liquid	-41.638
		vapor	-40.938
89	1.304	liquid	-41.052
		vapor	-40.357
90	1.338	liquid	-40.477
		vapor	-39.784
91	1.372	liquid	-39.914
		vapor	-39.224
92	1.407	liquid	-39.363
		vapor	-38.675
93	1.441	liquid	-38.819
		vapor	-38.136
94	1.476	liquid	-38.289
		vapor	-37.606
95	1.510	liquid	-37.767
		vapor	-37.088
96	1.544	liquid	-37.254
		vapor	-36.577
97	1.578	liquid	-36.750
		vapor	-36.076
98	1.613	liquid	-36.255
		vapor	-35.581
99	1.647	liquid	-35.768
		vapor	-35.094
100	1.681	liquid	-35.286
		vapor	-34.616
101	1.716	liquid	-34.813
		vapor	-34.146
102	1.750	liquid	-34.347
		vapor	-33.682
103	1.784	liquid	-33.888
		vapor	-33.226
104	1.819	liquid	-33.436
		vapor	-32.774
105	1.853	liquid	-32.992
		vapor	-32.332

# CONVERSION TABLE - 0/7 BAR R404A SENSOR TECHNICAL DATA SHEET

U VALUE	PRESSURE in bars	PHASE	TEMP. °C
106	1.887	liquid	-32.552
		vapor	-31.894
107	1.922	liquid	-32.119
		vapor	-31.464
108	1.956	liquid	-31.693
		vapor	-31.038
109	1.990	liquid	-31.272
		vapor	-30.619
110	2.024	liquid	-30.856
		vapor	-30.203
111	2.059	liquid	-30.444
		vapor	-29.792
112	2.093	liquid	-30.035
		vapor	-29.387
113	2.127	liquid	-29.633
		vapor	-28.988
114	2.162	liquid	-29.237
		vapor	-28.593
115	2.196	liquid	-28.846
		vapor	-28.202
116	2.230	liquid	-28.458
		vapor	-27.817
117	2.265	liquid	-28.075
		vapor	-27.434
118	2.299	liquid	-27.696
		vapor	-27.058
119	2.333	liquid	-27.321
		vapor	-26.686
120	2.368	liquid	-26.951
		vapor	-26.317
121	2.402	liquid	-26.585
		vapor	-25.953
122	2.436	liquid	-26.223
		vapor	-25.594
123	2.471	liquid	-25.866
		vapor	-25.236
124	2.505	liquid	-25.511
		vapor	-24.884
125	2.539	liquid	-25.161
		vapor	-24.536
126	2.574	liquid	-24.815
		vapor	-24.191
127	2.608	liquid	-24.471
		vapor	-23.850
128	2.642	liquid	-24.132
		vapor	-23.512
129	2.676	liquid	-23.796
		vapor	-23.176
130	2.711	liquid	-23.463
		vapor	-22.845
131	2.745	liquid	-23.131
		vapor	-22.517

U VALUE	PRESSURE in bars	PHASE	TEMP. °C
132	2.779	liquid	-22.805
		vapor	-22.193
133	2.814	liquid	-22.482
		vapor	-21.871
134	2.848	liquid	-22.162
		vapor	-21.552
135	2.882	liquid	-21.845
		vapor	-21.235
136	2.917	liquid	-21.529
		vapor	-20.922
137	2.951	liquid	-21.218
		vapor	-20.611
138	2.985	liquid	-20.908
		vapor	-20.304
139	3.020	liquid	-20.602
		vapor	-19.999
140	3.054	liquid	-20.298
		vapor	-19.697
141	3.088	liquid	-19.998
		vapor	-19.397
142	3.123	liquid	-19.699
		vapor	-19.099
143	3.157	liquid	-19.403
		vapor	-18.806
144	3.191	liquid	-19.108
		vapor	-18.512
145	3.225	liquid	-18.818
		vapor	-18.224
146	3.260	liquid	-18.529
		vapor	-17.935
147	3.294	liquid	-18.243
		vapor	-17.650
148	3.328	liquid	-17.959
		vapor	-17.368
149	3.363	liquid	-17.676
		vapor	-17.087
150	3.397	liquid	-17.396
		vapor	-16.808
151	3.431	liquid	-17.119
		vapor	-16.533
152	3.466	liquid	-16.844
		vapor	-16.258
153	3.500	liquid	-16.571
		vapor	-15.986
154	3.534	liquid	-16.299
		vapor	-15.716
155	3.569	liquid	-16.029
		vapor	-15.447
156	3.603	liquid	-15.762
		vapor	-15.182
157	3.637	liquid	-15.497
		vapor	-14.917

# CONVERSION TABLE - 0/7 BAR R404A SENSOR

## TECHNICAL DATA SHEET

U VALUE	PRESSURE in bars	PHASE	TEMP. °C
158	3.672	liquid	-15.233
		vapor	-14.655
159	3.706	liquid	-14.972
		vapor	-14.395
160	3.740	liquid	-14.712
		vapor	-14.136
161	3.774	liquid	-14.454
		vapor	-13.879
162	3.809	liquid	-14.197
		vapor	-13.624
163	3.843	liquid	-13.943
		vapor	-13.371
164	3.878	liquid	-13.690
		vapor	-13.120
165	3.912	liquid	-13.439
		vapor	-12.869
166	3.946	liquid	-13.190
		vapor	-12.621
167	3.980	liquid	-12.943
		vapor	-12.375
168	4.015	liquid	-12.697
		vapor	-12.130
169	4.049	liquid	-12.452
		vapor	-11.887
170	4.083	liquid	-12.209
		vapor	-11.644
171	4.118	liquid	-11.968
		vapor	-11.404
172	4.152	liquid	-11.728
		vapor	-11.166
173	4.186	liquid	-11.489
		vapor	-10.929
174	4.221	liquid	-11.253
		vapor	-10.693
175	4.255	liquid	-11.017
		vapor	-10.459
176	4.289	liquid	-10.783
		vapor	-10.226
177	4.324	liquid	-10.551
		vapor	-9.994
178	4.358	liquid	-10.320
		vapor	-9.764
179	4.392	liquid	-10.090
		vapor	-9.536
180	4.426	liquid	-9.862
		vapor	-9.309
181	4.461	liquid	-9.635
		vapor	-9.083
182	4.495	liquid	-9.409
		vapor	-8.858
183	4.529	liquid	-9.184
		vapor	-8.635

U VALUE	PRESSURE in bars	PHASE	TEMP. °C
184	4.564	liquid	-8.962
		vapor	-8.412
185	4.598	liquid	-8.740
		vapor	-8.191
186	4.632	liquid	-8.520
		vapor	-7.972
187	4.667	liquid	-8.300
		vapor	-7.754
188	4.701	liquid	-8.082
		vapor	-7.537
189	4.735	liquid	-7.865
		vapor	-7.321
190	4.770	liquid	-7.649
		vapor	-7.107
191	4.804	liquid	-7.435
		vapor	-6.893
192	4.838	liquid	-7.221
		vapor	-6.680
193	4.873	liquid	-7.010
		vapor	-6.469
194	4.907	liquid	-6.798
		vapor	-6.259
195	4.941	liquid	-6.589
		vapor	-6.049
196	4.975	liquid	-6.379
		vapor	-5.843
197	5.010	liquid	-6.172
		vapor	-5.636
198	5.044	liquid	-5.966
		vapor	-5.430
199	5.078	liquid	-5.760
		vapor	-5.225
200	5.113	liquid	-5.555
		vapor	-5.021
201	5.147	liquid	-5.352
		vapor	-4.818
202	5.181	liquid	-5.150
		vapor	-4.617
203	5.216	liquid	-4.947
		vapor	-4.416
204	5.250	liquid	-4.747
		vapor	-4.216
205	5.284	liquid	-4.548
		vapor	-4.018
206	5.319	liquid	-4.349
		vapor	-3.820
207	5.353	liquid	-4.151
		vapor	-3.624
208	5.387	liquid	-3.955
		vapor	-3.428
209	5.422	liquid	-3.759
		vapor	-3.234

# CONVERSION TABLE - 0/7 BAR R404A SENSOR TECHNICAL DATA SHEET

U VALUE	PRESSURE in bars	PHASE	TEMP. °C
210	5.456	liquid	-3.565
		vapor	-3.040
211	5.490	liquid	-3.371
		vapor	-2.847
212	5.525	liquid	-3.178
		vapor	-2.654
213	5.559	liquid	-2.987
		vapor	-2.464
214	5.593	liquid	-2.795
		vapor	-2.274
215	5.627	liquid	-2.605
		vapor	-2.084
216	5.662	liquid	-2.415
		vapor	-1.896
217	5.696	liquid	-2.227
		vapor	-1.708
218	5.730	liquid	-2.039
		vapor	-1.521
219	5.765	liquid	-1.853
		vapor	-1.336
220	5.799	liquid	-1.667
		vapor	-1.150
221	5.833	liquid	-1.482
		vapor	-0.967
222	5.868	liquid	-1.298
		vapor	-0.783
223	5.902	liquid	-1.115
		vapor	-0.600
224	5.936	liquid	-0.931
		vapor	-0.418
225	5.971	liquid	-0.750
		vapor	-0.237
226	6.005	liquid	-0.569
		vapor	-0.057
227	6.039	liquid	-0.389
		vapor	0.122
228	6.074	liquid	-0.209
		vapor	0.301
229	6.108	liquid	-0.030
		vapor	0.478
230	6.142	liquid	0.147
		vapor	0.656
231	6.176	liquid	0.325
		vapor	0.832
232	6.211	liquid	0.501
		vapor	1.008

U VALUE	PRESSURE in bars	PHASE	TEMP. °C
233	6.245	liquid	0.677
		vapor	1.183
234	6.279	liquid	0.852
		vapor	1.357
235	6.314	liquid	1.026
		vapor	1.531
236	6.348	liquid	1.200
		vapor	1.703
237	6.382	liquid	1.372
		vapor	1.875
238	6.417	liquid	1.544
		vapor	2.046
239	6.451	liquid	1.716
		vapor	2.218
240	6.485	liquid	1.887
		vapor	2.387
241	6.520	liquid	2.057
		vapor	2.557
242	6.554	liquid	2.226
		vapor	2.725
243	6.588	liquid	2.395
		vapor	2.893
244	6.623	liquid	2.563
		vapor	3.061
245	6.657	liquid	2.730
		vapor	3.228
246	6.691	liquid	2.897
		vapor	3.393
247	6.726	liquid	3.063
		vapor	3.559
248	6.760	liquid	3.229
		vapor	3.723
249	6.794	liquid	3.393
		vapor	3.888
250	6.829	liquid	3.558
		vapor	4.051
251	6.863	liquid	3.721
		vapor	4.214
252	6.897	liquid	3.884
		vapor	4.376
253	6.931	liquid	4.047
		vapor	4.538
254	6.966	liquid	4.208
		vapor	4.699
255	7.000	liquid	4.370
		vapor	4.860

# CONVERSION TABLE - 0/25 BAR R404A SENSOR

## TECHNICAL DATA SHEET

U VALUE	PRESSURE in bars	PHASE	TEMP. °C
53	0.245	liquid	-72.224
		vapor	-71.373
54	0.368	liquid	-65.573
		vapor	-64.750
55	0.490	liquid	-60.531
		vapor	-59.741
56	0.613	liquid	-56.425
		vapor	-55.654
57	0.735	liquid	-52.925
		vapor	-52.173
58	0.858	liquid	-49.864
		vapor	-49.131
59	0.980	liquid	-47.135
		vapor	-46.411
60	1.103	liquid	-44.661
		vapor	-43.949
61	1.226	liquid	-42.395
		vapor	-41.693
62	1.348	liquid	-40.300
		vapor	-39.609
63	1.471	liquid	-38.349
		vapor	-37.665
64	1.593	liquid	-36.520
		vapor	-35.846
65	1.716	liquid	-34.799
		vapor	-34.129
66	1.838	liquid	-33.164
		vapor	-32.504
67	1.961	liquid	-31.615
		vapor	-30.962
68	2.083	liquid	-30.135
		vapor	-29.484
69	2.206	liquid	-28.716
		vapor	-28.072
70	2.329	liquid	-27.356
		vapor	-26.719
71	2.451	liquid	-26.050
		vapor	-25.421
72	2.574	liquid	-24.795
		vapor	-24.172
73	2.696	liquid	-23.586
		vapor	-22.968
74	2.819	liquid	-22.417
		vapor	-21.805
75	2.941	liquid	-21.287
		vapor	-20.680
76	3.064	liquid	-20.192
		vapor	-19.591
77	3.186	liquid	-19.130
		vapor	-18.534
78	3.309	liquid	-18.100
		vapor	-17.508

U VALUE	PRESSURE in bars	PHASE	TEMP. °C
79	3.431	liquid	-17.098
		vapor	-16.512
80	3.554	liquid	-16.124
		vapor	-15.542
81	3.677	liquid	-15.174
		vapor	-14.596
82	3.799	liquid	-14.249
		vapor	-13.676
83	3.922	liquid	-13.346
		vapor	-12.777
84	4.044	liquid	-12.465
		vapor	-11.900
85	4.167	liquid	-11.604
		vapor	-11.042
86	4.289	liquid	-10.761
		vapor	-10.204
87	4.412	liquid	-9.937
		vapor	-9.383
88	4.534	liquid	-9.130
		vapor	-8.580
89	4.657	liquid	-8.340
		vapor	-7.794
90	4.779	liquid	-7.565
		vapor	-7.022
91	4.902	liquid	-6.805
		vapor	-6.266
92	5.025	liquid	-6.060
		vapor	-5.523
93	5.147	liquid	-5.328
		vapor	-4.795
94	5.270	liquid	-4.609
		vapor	-4.079
95	5.392	liquid	-3.903
		vapor	-3.377
96	5.515	liquid	-3.209
		vapor	-2.685
97	5.637	liquid	-2.527
		vapor	-2.006
98	5.760	liquid	-1.855
		vapor	-1.338
99	5.882	liquid	-1.195
		vapor	-0.681
100	6.005	liquid	-0.545
		vapor	-0.033
101	6.127	liquid	0.096
		vapor	0.605
102	6.250	liquid	0.727
		vapor	1.233
103	6.372	liquid	1.349
		vapor	1.851
104	6.495	liquid	1.961
		vapor	2.461

# CONVERSION TABLE - 0/25 BAR R404A SENSOR TECHNICAL DATA SHEET

U VALUE	PRESSURE in bars	PHASE	TEMP. °C
105	6.618	liquid	2.564
		vapor	3.062
106	6.740	liquid	3.160
		vapor	3.655
107	6.863	liquid	3.747
		vapor	4.240
108	6.985	liquid	4.326
		vapor	4.816
109	7.108	liquid	4.899
		vapor	5.386
110	7.230	liquid	5.463
		vapor	5.948
111	7.353	liquid	6.020
		vapor	6.502
112	7.476	liquid	6.570
		vapor	7.050
113	7.598	liquid	7.114
		vapor	7.591
114	7.721	liquid	7.650
		vapor	8.126
115	7.843	liquid	8.181
		vapor	8.654
116	7.966	liquid	8.705
		vapor	9.176
117	8.088	liquid	9.224
		vapor	9.693
118	8.211	liquid	9.736
		vapor	10.202
119	8.333	liquid	10.243
		vapor	10.707
120	8.456	liquid	10.744
		vapor	11.206
121	8.578	liquid	11.240
		vapor	11.700
122	8.701	liquid	11.730
		vapor	12.188
123	8.823	liquid	12.216
		vapor	12.671
124	8.946	liquid	12.696
		vapor	13.149
125	9.069	liquid	13.171
		vapor	13.622
126	9.191	liquid	13.642
		vapor	14.091
127	9.314	liquid	14.107
		vapor	14.554
128	9.436	liquid	14.568
		vapor	15.014
129	9.559	liquid	15.025
		vapor	15.468
130	9.681	liquid	15.478
		vapor	15.919

U VALUE	PRESSURE in bars	PHASE	TEMP. °C
131	9.804	liquid	15.926
		vapor	16.365
132	9.926	liquid	16.370
		vapor	16.807
133	10.049	liquid	16.810
		vapor	17.245
134	10.171	liquid	17.246
		vapor	17.679
135	10.294	liquid	17.677
		vapor	18.109
136	10.417	liquid	18.105
		vapor	18.535
137	10.539	liquid	18.530
		vapor	18.957
138	10.662	liquid	18.950
		vapor	19.376
139	10.784	liquid	19.367
		vapor	19.791
140	10.907	liquid	19.781
		vapor	20.203
141	11.029	liquid	20.191
		vapor	20.611
142	11.152	liquid	20.598
		vapor	21.016
143	11.274	liquid	21.001
		vapor	21.417
144	11.397	liquid	21.401
		vapor	21.816
145	11.520	liquid	21.797
		vapor	22.211
146	11.642	liquid	22.191
		vapor	22.603
147	11.765	liquid	22.582
		vapor	22.991
148	11.887	liquid	22.969
		vapor	23.377
149	12.010	liquid	23.354
		vapor	23.760
150	12.132	liquid	23.736
		vapor	24.140
151	12.255	liquid	24.115
		vapor	24.517
152	12.377	liquid	24.490
		vapor	24.891
153	12.500	liquid	24.863
		vapor	25.262
154	12.623	liquid	25.234
		vapor	25.631
155	12.745	liquid	25.602
		vapor	25.997
156	12.868	liquid	25.966
		vapor	26.361

# CONVERSION TABLE - 0/25 BAR R404A SENSOR TECHNICAL DATA SHEET

U VALUE	PRESSURE in bars	PHASE	TEMP. °C
157	12.990	liquid	26.329
		vapor	26.722
158	13.113	liquid	26.689
		vapor	27.080
159	13.235	liquid	27.047
		vapor	27.436
160	13.358	liquid	27.402
		vapor	27.789
161	13.480	liquid	27.754
		vapor	28.140
162	13.603	liquid	28.104
		vapor	28.488
163	13.726	liquid	28.452
		vapor	28.835
164	13.848	liquid	28.798
		vapor	29.178
165	13.971	liquid	29.141
		vapor	29.520
166	14.093	liquid	29.482
		vapor	29.859
167	14.216	liquid	29.820
		vapor	30.196
168	14.338	liquid	30.157
		vapor	30.532
169	14.461	liquid	30.492
		vapor	30.865
170	14.583	liquid	30.824
		vapor	31.195
171	14.706	liquid	31.154
		vapor	31.524
172	14.828	liquid	31.483
		vapor	31.851
173	14.951	liquid	31.808
		vapor	32.175
174	15.074	liquid	32.133
		vapor	32.498
175	15.196	liquid	32.455
		vapor	32.819
176	15.319	liquid	32.775
		vapor	33.137
177	15.441	liquid	33.094
		vapor	33.454
178	15.564	liquid	33.410
		vapor	33.769
179	15.686	liquid	33.725
		vapor	34.082
180	15.809	liquid	34.037
		vapor	34.394
181	15.931	liquid	34.348
		vapor	34.703
182	16.054	liquid	34.658
		vapor	35.011

U VALUE	PRESSURE in bars	PHASE	TEMP. °C
183	16.176	liquid	34.965
		vapor	35.317
184	16.299	liquid	35.271
		vapor	35.621
185	16.422	liquid	35.575
		vapor	35.924
186	16.544	liquid	35.877
		vapor	36.225
187	16.667	liquid	36.178
		vapor	36.524
188	16.789	liquid	36.477
		vapor	36.821
189	16.912	liquid	36.774
		vapor	37.117
190	17.034	liquid	37.070
		vapor	37.411
191	17.157	liquid	37.364
		vapor	37.704
192	17.279	liquid	37.657
		vapor	37.995
193	17.402	liquid	37.948
		vapor	38.285
194	17.524	liquid	38.237
		vapor	38.573
195	17.647	liquid	38.526
		vapor	38.860
196	17.770	liquid	38.812
		vapor	39.145
197	17.892	liquid	39.097
		vapor	39.428
198	18.015	liquid	39.381
		vapor	39.711
199	18.137	liquid	39.663
		vapor	39.991
200	18.260	liquid	39.944
		vapor	40.271
201	18.382	liquid	40.223
		vapor	40.549
202	18.505	liquid	40.501
		vapor	40.825
203	18.627	liquid	40.778
		vapor	41.100
204	18.750	liquid	41.053
		vapor	41.374
205	18.872	liquid	41.327
		vapor	41.647
206	18.995	liquid	41.599
		vapor	41.918
207	19.118	liquid	41.871
		vapor	42.188
208	19.240	liquid	42.141
		vapor	42.456



# CONVERSION TABLE - 0/25 BAR R404A SENSOR TECHNICAL DATA SHEET

U VALUE	PRESSURE in bars	PHASE	TEMP. °C
209	19.363	liquid	42.409
		vapor	42.723
210	19.485	liquid	42.677
		vapor	42.989
211	19.608	liquid	42.943
		vapor	43.254
212	19.730	liquid	43.208
		vapor	43.518
213	19.853	liquid	43.472
		vapor	43.780
214	19.976	liquid	43.734
		vapor	44.041
215	20.098	liquid	43.995
		vapor	44.301
216	20.221	liquid	44.255
		vapor	44.560
217	20.343	liquid	44.514
		vapor	44.817
218	20.466	liquid	44.772
		vapor	45.074
219	20.588	liquid	45.029
		vapor	45.329
220	20.711	liquid	45.284
		vapor	45.583
221	20.833	liquid	45.538
		vapor	45.836
222	20.956	liquid	45.792
		vapor	46.088
223	21.078	liquid	46.044
		vapor	46.338
224	21.201	liquid	46.295
		vapor	46.588
225	21.323	liquid	46.545
		vapor	46.837
226	21.446	liquid	46.794
		vapor	47.084
227	21.569	liquid	47.042
		vapor	47.331
228	21.691	liquid	47.289
		vapor	47.576
229	21.814	liquid	47.534
		vapor	47.820
230	21.936	liquid	47.779
		vapor	48.063
231	22.059	liquid	48.023
		vapor	48.306
232	22.181	liquid	48.265
		vapor	48.547

U VALUE	PRESSURE in bars	PHASE	TEMP. °C
233	22.304	liquid	48.507
		vapor	48.787
234	22.426	liquid	48.748
		vapor	49.027
235	22.549	liquid	48.987
		vapor	49.265
236	22.672	liquid	49.226
		vapor	49.502
237	22.794	liquid	49.464
		vapor	49.739
238	22.917	liquid	49.701
		vapor	49.974
239	23.039	liquid	49.937
		vapor	50.209
240	23.162	liquid	50.172
		vapor	50.442
241	23.284	liquid	50.406
		vapor	50.675
242	23.407	liquid	50.639
		vapor	50.906
243	23.529	liquid	50.871
		vapor	51.137
244	23.652	liquid	51.102
		vapor	51.367
245	23.775	liquid	51.333
		vapor	51.596
246	23.897	liquid	51.562
		vapor	51.824
247	24.020	liquid	51.791
		vapor	52.051
248	24.142	liquid	52.018
		vapor	52.278
249	24.265	liquid	52.246
		vapor	52.503
250	24.387	liquid	52.471
		vapor	52.728
251	24.510	liquid	52.697
		vapor	52.952
252	24.632	liquid	52.921
		vapor	53.174
253	24.755	liquid	53.145
		vapor	53.396
254	24.877	liquid	53.367
		vapor	53.618
255	25.000	liquid	53.571
		vapor	53.820

The specifications and technical characteristics in this booklet are given for information purposes. The manufacturer reserves the right to modify them without prior notice or obligation to modify in a similar manner, the equipment previously supplied.

Réf: CLIMATIC CHILLER/GB/02-98

***LENNOX***<sup>®</sup>

---

**LENNOX France - Z.I. LES MEURIERES - BP 71 - 69780 MIONS - FRANCE**  
**TELEPHONE +33 (0)4 72 23 20 20 - TELECOPIE +33 (0)4 72 23 20 28**

**LENNOX France, Division Climatisation de LGL FRANCE S.A.**  
**Siège Social : LGL FRANCE S.A. - ZI "Les Meurières" - BP71 - France**