

**Chilled Water
Fan Coil**

Models: MMSB
MHSB
MDB

Contents

Product Features	3
Specifications	5
Cooling Properties	8
Fan Performance Curve	14
Wiring Diagrams	17
Outlines & Dimension	20
Parts List	23
Installation	28
Operation	29

Product Features

Medium - High Static Pressure - Easy choice of installation location

The approximate total static pressure for the various models are:

Model	Total Static Pressure		External Static Pressure	
	IWG	Pa	IWG	Pa
MHSB030AW	0.65	161.75	0.59	146.82
MHSB040AW	0.62	154.28	0.59	146.82
MHSB050AW	0.61	151.79	0.59	146.82
MHSB060AW	0.65	161.75	0.59	146.82
MDB040BW	0.80	199.07	0.50	124.42
MDB050BW	0.80	199.07	0.35	87.09
MDB060BW	0.80	199.07	0.55	136.86
MDB075BW	0.80	199.07	0.50	124.42
MDB100BW	0.80	199.07	0.35	87.09
MMSB010AW	0.65	161.75	0.39	97.05
MMSB015AW	0.62	154.28	0.39	97.05
MMSB020AW	0.61	151.79	0.39	97.05
MMSB025AW	0.65	161.75	0.39	97.05
MMSB030AW	0.67	166.72	0.39	97.05

Quiet Operation

The new packaged type chilled water fan coil incorporates a new low noise centrifugal fan which ensures quiet operation.

The new casing is insulated internally to further reduce the sound level.

Easy Maintenance

The simple design concept has easy maintenance and servicing in mind. Access to internal part of the unit can be either from side panels or the bottom panel of the unit by loosening a few screws.

MMSB010AW - 030AW

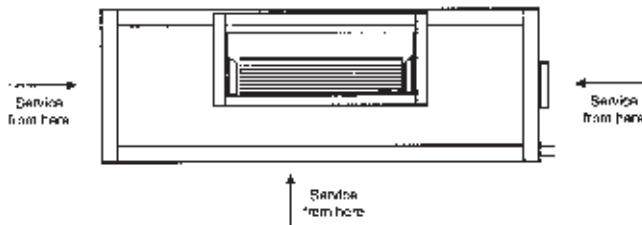

MDB040BW - 100BW

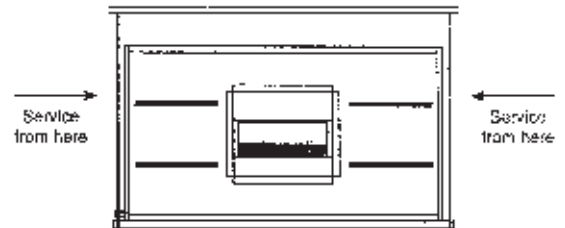

MHSB030AW - 060AW

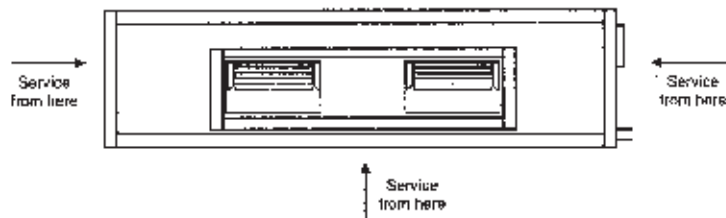

Flexibility

The packaged type chilled water fan coil unit come with standard horizontal air discharge.

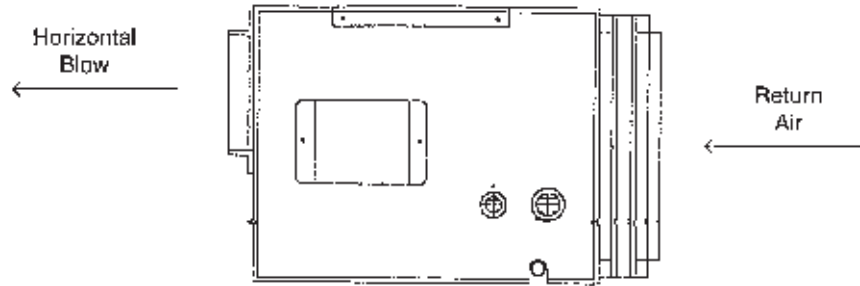

Filter Rack

The fan coil unit has a filter rack to hold the air filter. This filter will ensure the air is clean and it is easily accessible for maintenance and cleaning.

Fresh Air for Healthy Living

Fresh air in the air-conditioned space is essential for health and comfort. This is easily achieved in the case of packaged type Chilled Water Fan Coil Units by introducing predetermined amount of fresh air.

Elegant, Neat and Tidy

While the rest of the unit are concealed, the wall or ceiling air grilles are exposed. The design concept has in mind:

- a) Aesthetic beauty
- b) Optimum space utilization
- c) Excellent air distribution

It is ideal for office, hotel, hospital and restaurants application.

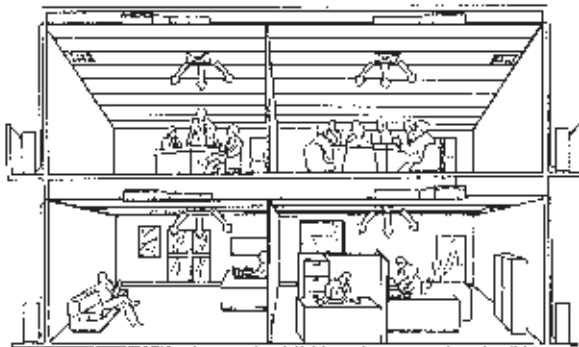

Specially Designed for Easy Duct Connection and Low Ceiling Installation Space

For the ceiling mounted packaged Chilled Water Fan Coil Units, air outlets flanges are nearer to the lower edge of the unit, such that the unit can be hung higher up and closer to ceiling, which give no difficulty for the air ducts to clear the ceiling beams. The final result is that the false ceiling can be built higher up and the area below appear more spacious.

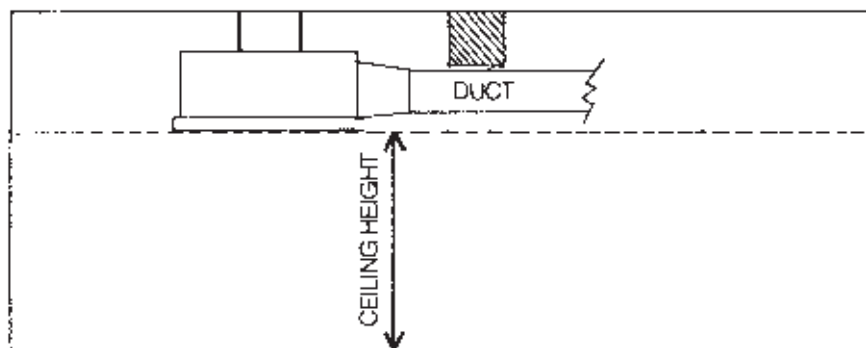

Specification

Medium Static Blower

MODEL		MMSB				
		010AW	015AW	020AW	025AW	030AW
PERFORMANCE						
Air Flow	CFM	300	450	600	750	900
	CMH	510	765	1020	1275	1530
Total Cooling Capacity	Kcal/ hr	2270	3650	4540	5800	7200
	kw	2.637	4.249	5.274	6.739	8.380
	Btu/hr	9000	14500	18000	23000	28600
Sensible Cooling Capacity	Kcal/hr	1640	2570	3280	4160	5070
	kw	1.904	2.989	3.809	4.835	5.890
	Btu/hr	6500	10200	13000	16500	20100
Water Flow Rate	(l / min)/GPM	7.56/ 2.0	11.34/3.0	15.12/4.0	18.90/5.0	22.68/6.0
Head Loss	(mAq)/ftAq	0.98/ 3.2	2.35/7.7	1.04/3.4	1.74/5.7	2.65/8.7
External Static Pressure	High Speed	(mmAq)/(pa)	10/ 97.97			
	Medium Speed	(mmAq)/(pa)	7/ 68.58			
	Low Speed	(mmAq)/(pa)	5/ 48.98			
COIL						
Type	Seamless copper tube mechanically boded to aluminium slit fin					
Tube	OD 9.52mm, thickness 0.35mm					
Fin thickness	0.11mm					
Connection	OD. 3/4" Copper tube					
Number of rows / fin per inch	3R, 12 FPI					
Max. Working Pressure	(kg/cm ²)(psi)	16.4/ 233				
Testing Pressure	30 kg/cm ² for 1 min, leak test : 16kg/cm ² for 5 min					
Surface Area	m ² /ft ²	0.11/1.20	0.17/1.80	0.20/ 2.20	0.25/2.67	0.30/3.21
Surface Air Velocity	(m/s)(ft/min)	1.32/ 260	1.33/261	1.44/ 284	1.48/ 292	1.48/292
Piping Direction	Right Hand Piping					
MOTOR						
Type	Permanent Split-Capacitor Motor					
Power Supply	V/ph/Hz	240 / 1/50				
Running Current	Amp	0.74	0.87	0.91	1.16	1.28
Rated Output	W	130	130	130	130	180
Poles	4					
Number of Motor	1					
FAN						
Type / Drive	Centrifugal / Direct Drive					
Number of Fans	1			2		
AIR FILTER (OPTIONAL)						
Type	Washable Saranet Filter					
	Length x Height	mm	401 x 229	599 x 229	376 x 229	454 x 229
			543 x 229			
Quantity	1			2		
WEIGHT	kg	23	28	34	38	43

Conditions

Cooling Capacity : Entering air temp. : 27⁰C(80⁰F) DB, 19.5⁰C (67⁰F) WB
 entering water temp. : 7.2⁰C (45⁰F), leaving water temp.: 12.7⁰C(55⁰F)
 Airflow : under dry condition

High Static Blower

MODEL		MHSB				
		030AW	040AW	050AW	060AW	
PERFORMANCE						
Air Flow	CFM	900	1200	1500	1800	
	L/s	424.8	566.4	708.0	849.6	
Total Cooling Capacity	Kcal/ hr	6960	9680	12600	13700	
	kw	8.087	11.251	14.650	15.939	
	Btu/hr	27600	38400	50000	54400	
Sensible Cooling Capacity	Kcal/hr	5010	6900	8870	10050	
	kw	5.831	8.028	10.314	11.691	
	Btu/hr	19900	27400	35200	39900	
Water Flow Rate	(l / min)/GPM	22.7/ 6.0	30.2/ 8.0	37.8/ 10.0	45.4/12.0	
Head Loss	(mAq)/ftAq	1.2/ 4.0	2.2/ 7.2	3.8/ 12.4	0.9/ 2.8	
External Static Pressure	High Speed	(mmAq)/(pa)	15/ 146.95			
	Medium Speed	(mmAq)/(pa)	10/ 97.80			
	Low Speed	(mmAq)/(pa)	5/ 48.98			
COIL						
Type	Seamless copper tube mechanically boded to Al slit fin					
Tube	OD 9.52mm, thickness 0.35mm					
Fin thickness	0.11mm					
Connection	OD. 7/8" Copper tube					
Number of rows / fin per inch	3/12	3/14	3/14	3/14	3/14	
Max Working Pressure	(kg/cm ²)(psi)	16.4/ 233				
Testing Pressure	30 kg/cm ² for 1 min, leak test : 16kg/cm ² for 5 min					
Surface Area	m ² /ft ²	0.28/ 2.98	0.32/ 3.44	0.41/ 4.40	0.48/ 5.16	
Surface Air Velocity	(m/s)(ft/min)	1.48/ 292	1.72/ 338	1.68/ 330	1.72/ 338	
Piping Direction	Right Hand Piping					
MOTOR						
Type	Permanent Split-Capacitor Motor					
Power Supply	V/ph/Hz	220 - 240/ 1/50				
Running Current	Amp	2.57	2.59	2.88	2.94	
Rated Output	W	320	320	600	600	
Poles	4					
Number of Motor	1					
FAN						
Type / Drive	Centrifugal / Direct Drive					
Number of Fans	2					
AIR FILTER (OPTIONAL)						
Type	Washable Saranet Filter					
	Length x Height	mm	400 x 308	460 x 308	586 x 308	686 x 308
Quantity	2					
WEIGHT	kg	39	42	54	62	

Conditions

Cooling Capacity : Entering air temp. : 27⁰C(80⁰F) DB, 19.5⁰C (67⁰F) WB
 entering water temp. : 7.2⁰C (45⁰F), leaving water temp.: 12.7⁰C(55⁰F)
 Airflow : under dry condition

Static Chilled Water Fan Coil

MODEL		MDB				
		040BW	050BW	060BW	075BW	100BW
PERFORMANCE						
Air Flow	CFM	1250	1500	2000	2500	3000
	L/s	590	708	944	1180	1416
Total Cooling Capacity	Kca/ hr	9400	12878	16255	19204	26840
	kw	10.929	14.972	18.899	22.327	31.205
	Btu/hr	37300	51100	64500	76200	106500
Sensible Cooling Capacity	Kcal/hr	6275	8629	10885	12835	17319
	kw	7.295	10.032	12.655	14.922	20.135
	Btu/hr	24900	34240	43190	50930	68720
Water Flow Rate	(/ min)/GPM	28.2/ 7.44	38.7/10.22	48.8/ 12.90	57.8/15.27	80.6/21.30
Head Loss	(mAq)/ftAq	0.85/ 2.8	1.74/5.7	2.93/9.6	1.49/4.9	1.71/5.6
External Static Pressure	(mmAq)/(pa)	12.7/ 124.42	9.0/88.17	14.0/137.16	12.7/124.42	9.0/88.17
COIL						
Type	Seamless copper tube mechanically boded to aluminium slit fin					
Tube	OD 9.52mm, thickness 0.35mm					
Fin thickness	0.11mm					
Connection	OD. 7/8" Copper tube			O.D. :1 1/8" Copper tube		
Number of rows / fin per inch	3/12	4/12	3/12	3/12	4/12	
Max Working Pressure	(kg/cm ²)(psi)	16.4/ 233				
Testing Pressure	30 kg/cm ² for 1 min. (leak test : 16kg/cm ² for 5 min)					
Surface Area	m ² /ft ²	0.26/2.81	0.26/2.81	0.49/5.31	0.54/5.82	0.54/5.82
Surface Air Velocity	(m/s)(ft/min)	2.26/445	2.71/534	1.92/377	2.18/430	2.62/515
Piping Direction	Right Hand Piping					
MOTOR						
Type	Permanent Split-Capacitor Motor with sleeve Bearing					
Power Supply	V/ph/Hz	220-240/ 1/50-60				
Rated Input	W	350	436	2 x 350	2 x 350	2 x 436
Rated Output	W	248	373	2 x 248	2 x 248	2 x 373
Poles	6					
Number of Motor		1	1	2	2	2
FAN						
Type / Drive	Centrifugal fan (forward- Curved)					
Number of Fans		1	1	2	2	2
AIR FILTER (OPTIONAL)						
Type	Washable Saranet Filter					
	Length x Height	mm				
		622 x 433				
Quantity		1			2	
WEIGHT	kg	50	55	85	96	100

Conditions

Cooling Capacity : Entering air temp. : 27⁰C(80⁰F) DB, 19.5⁰C (67⁰F) WB
 entering water temp. : 7.2⁰C (45⁰F), leaving water temp.: 12.7⁰C(55⁰F)

Airflow : under dry condition

Cooling Properties

Model: MMSB010AW

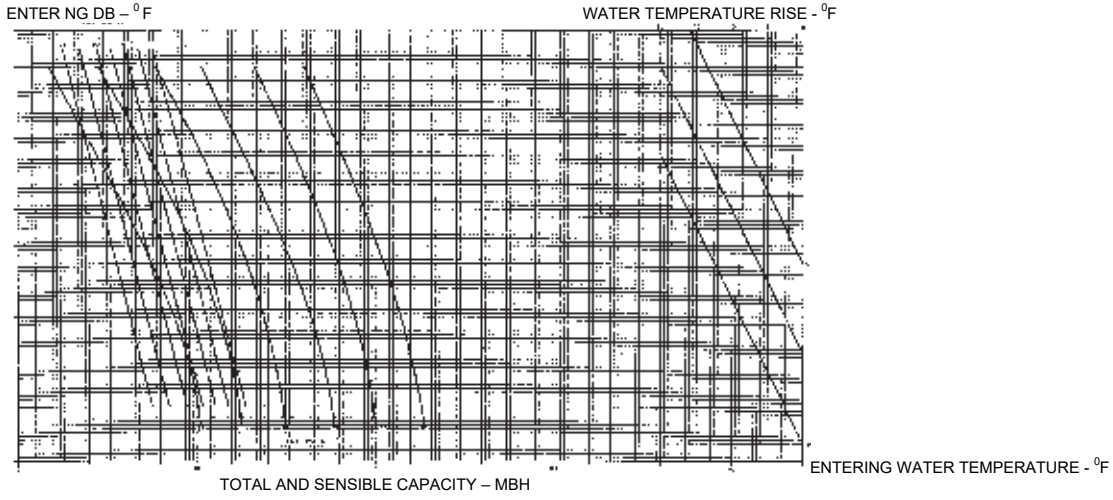

Model: MMSB015AW

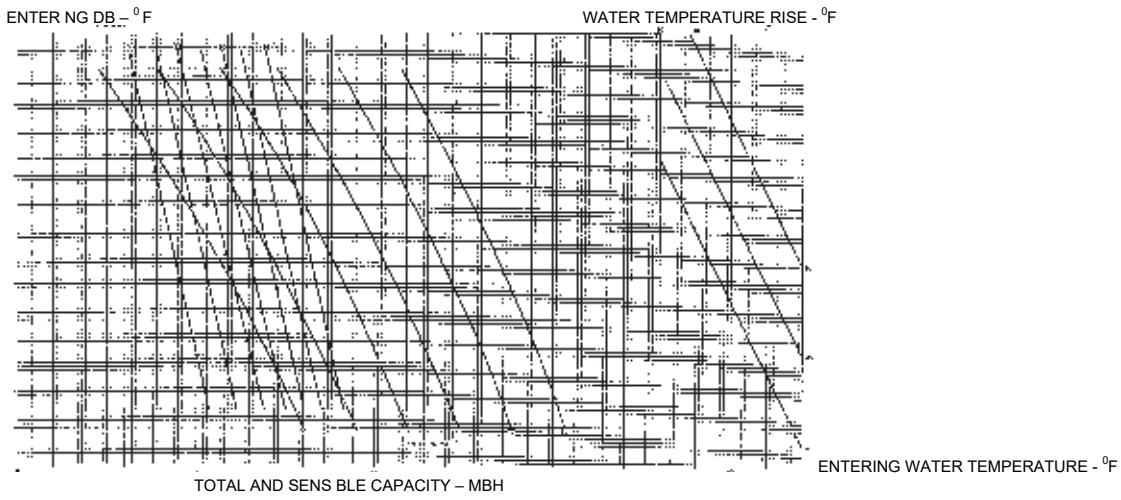

Model: MMSB020AW

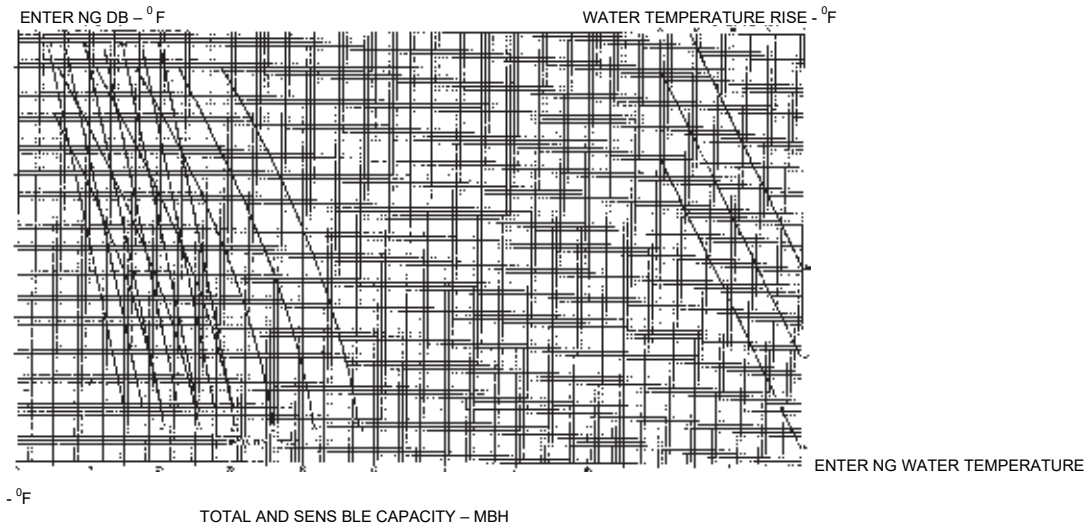

Model: MMSB025AW

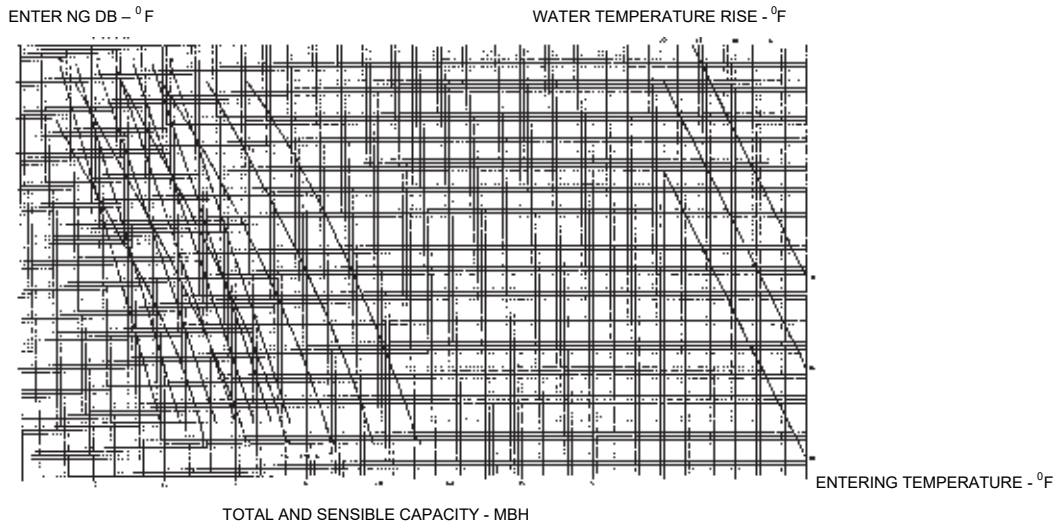

Model: MMSB030AW

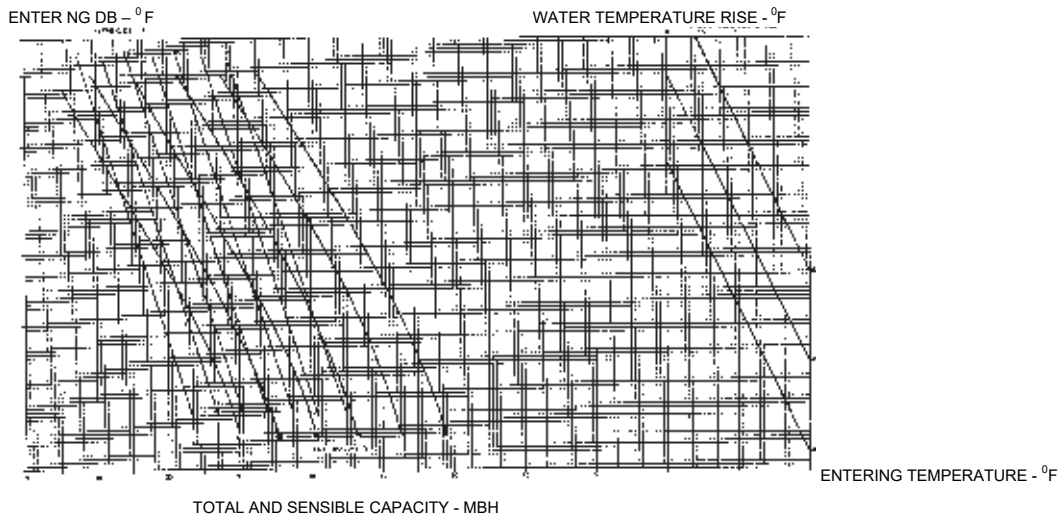

Model: MHSB030AW

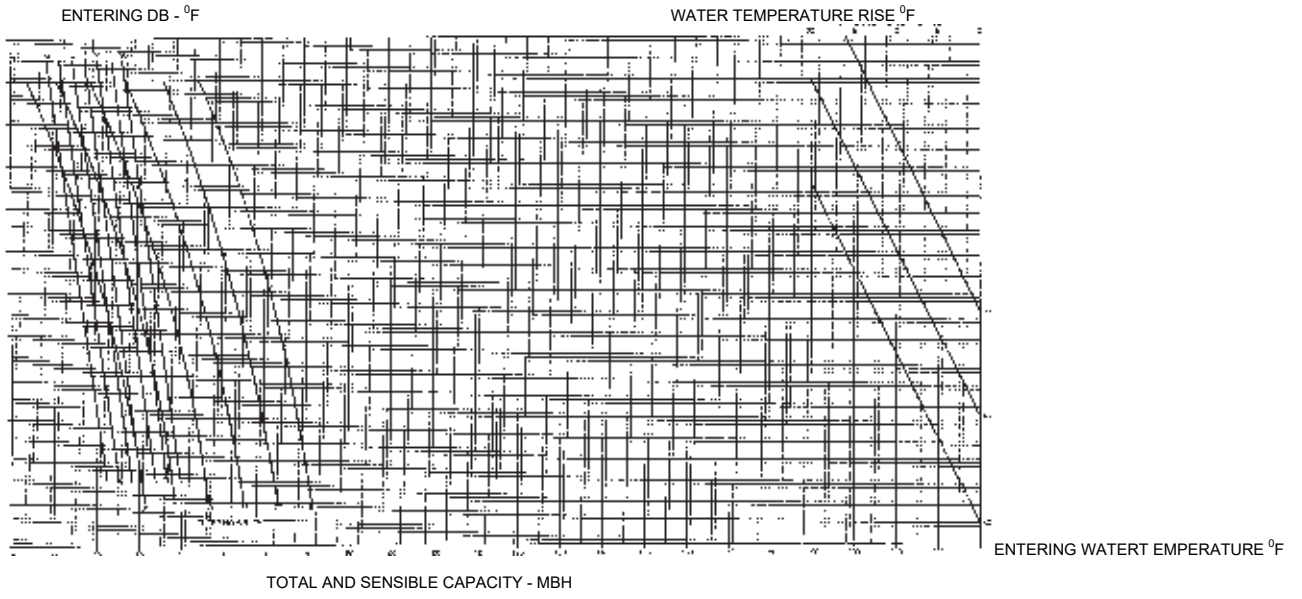

Model: MHSB040AW

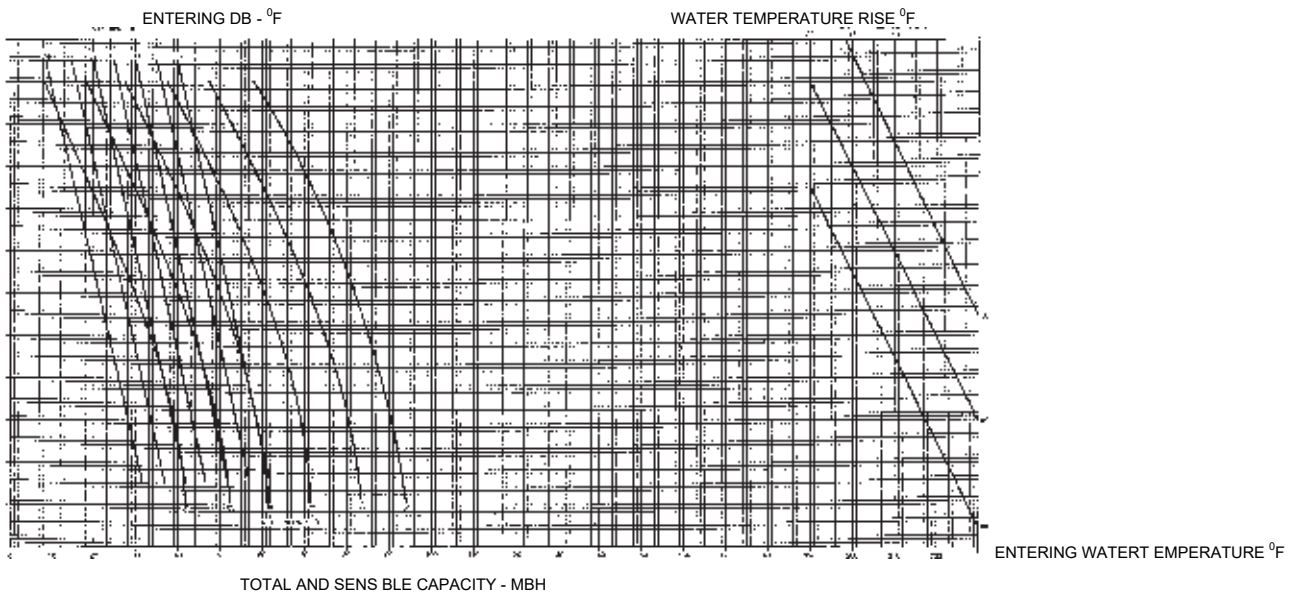

Model: MHSB050AW

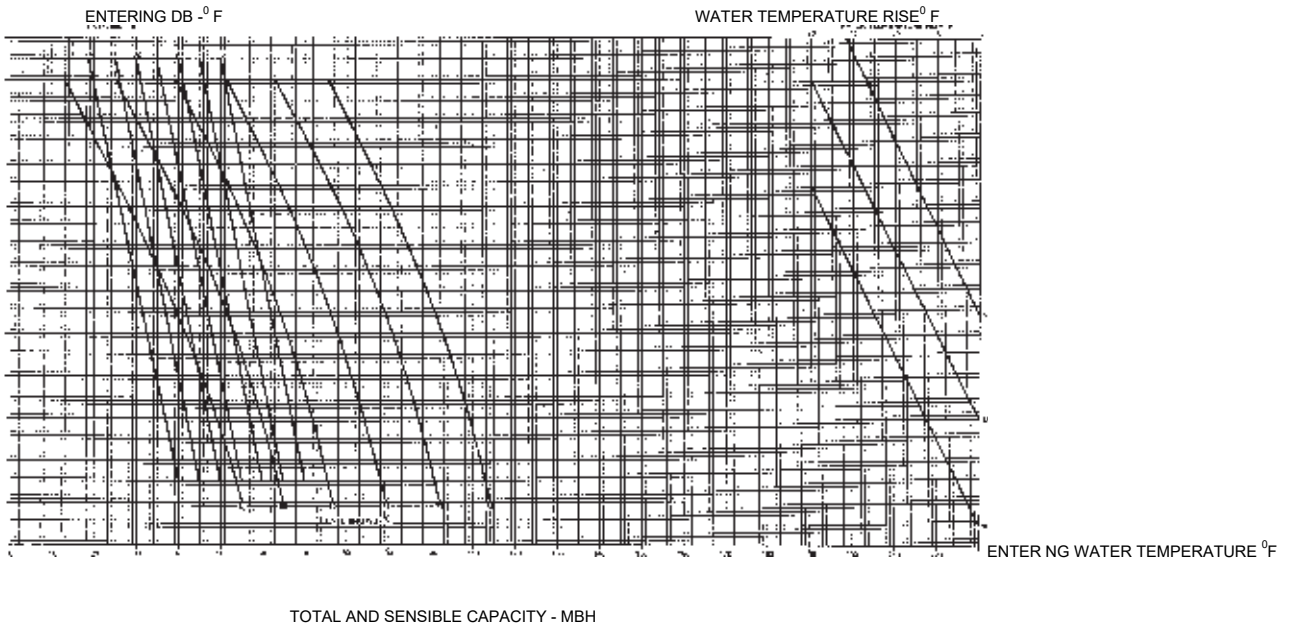

Model: MHSB060AW

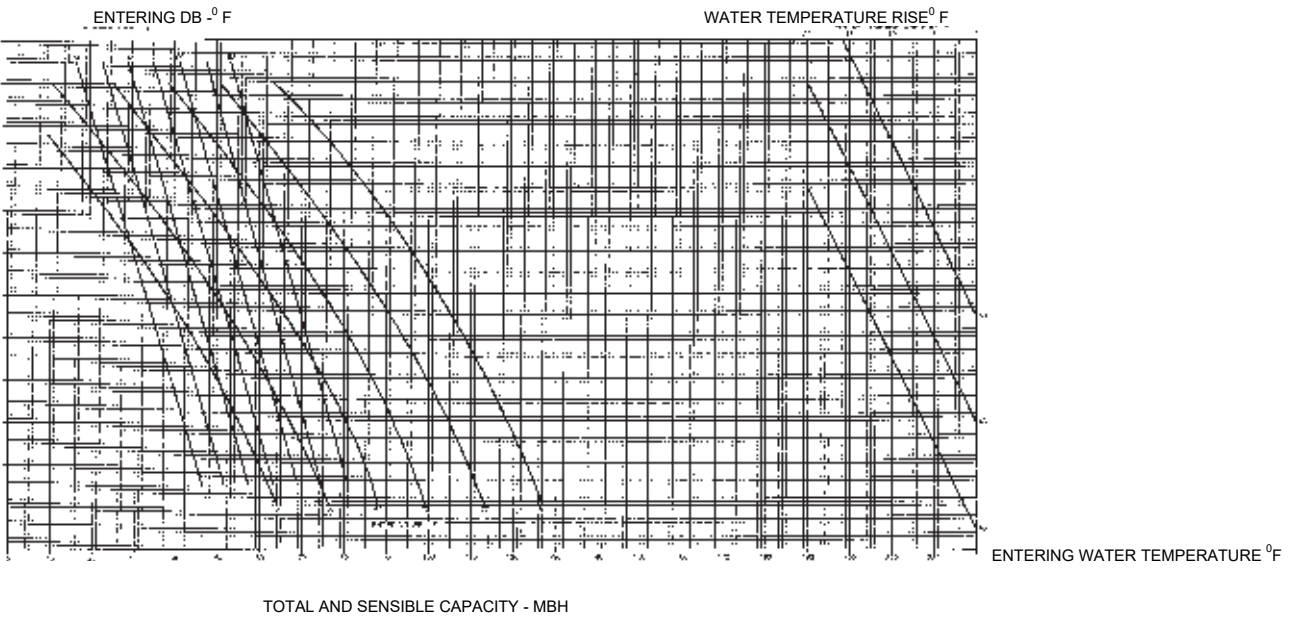

Model: MDB040BW

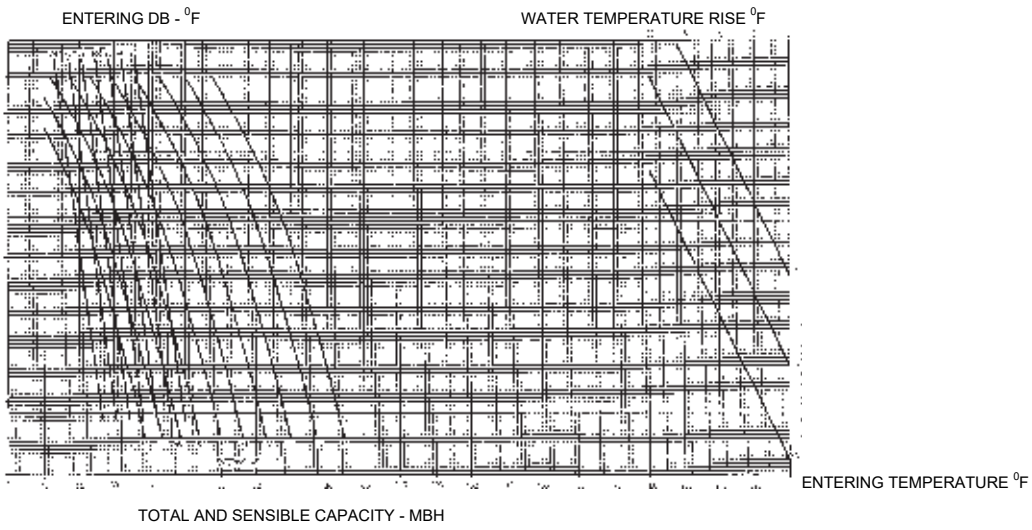

Model: MDB050BW

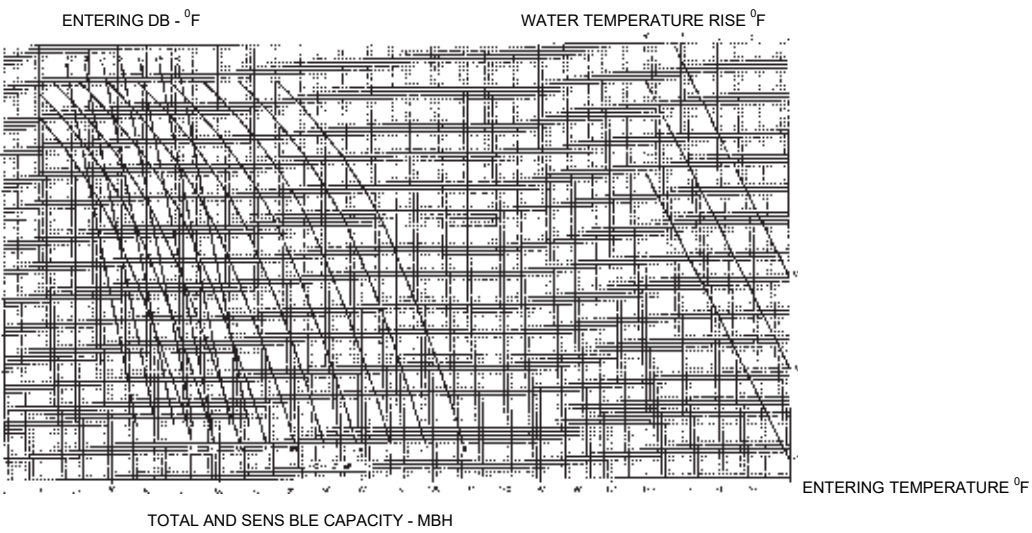

Model: MDB060BW

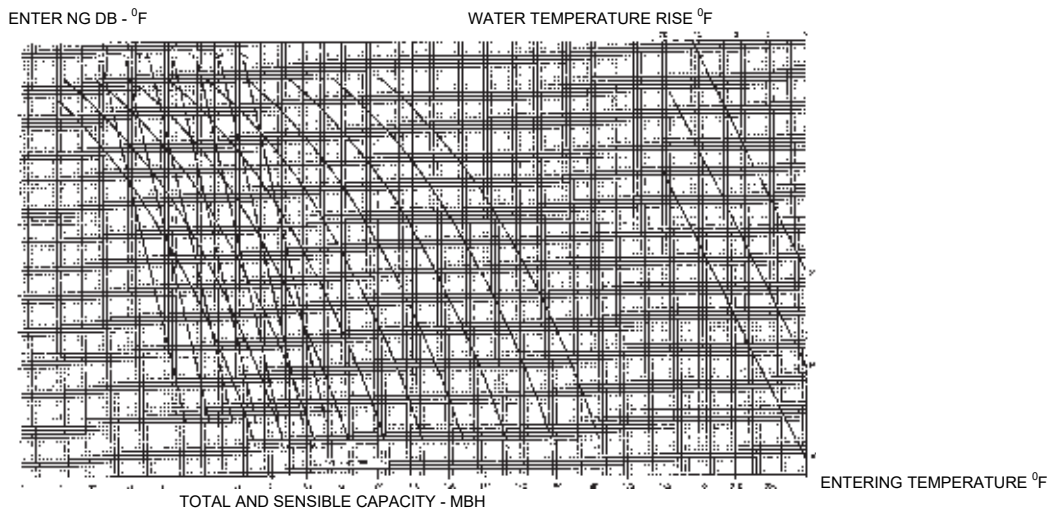

Model: MDB075BW

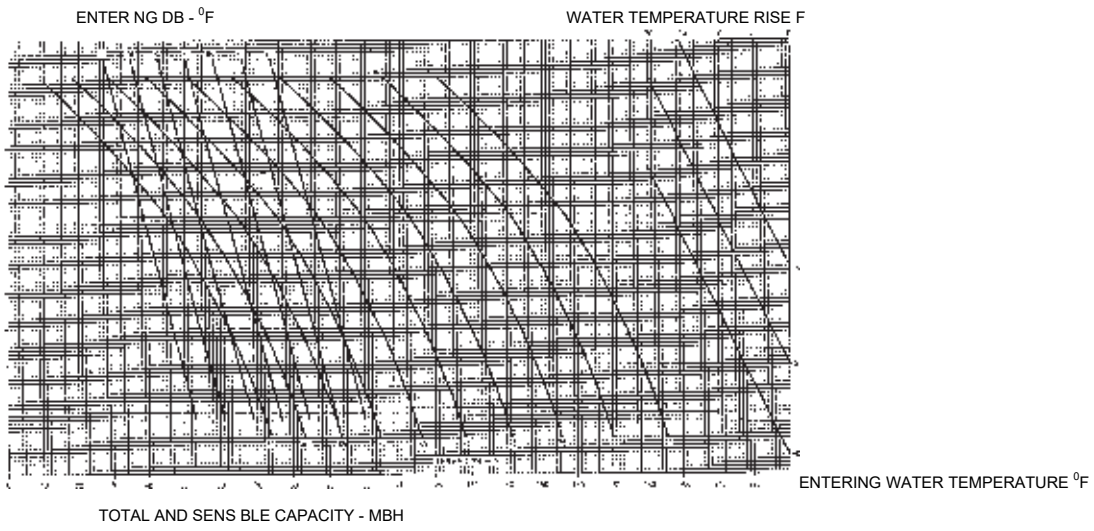

Model: MDB100BW

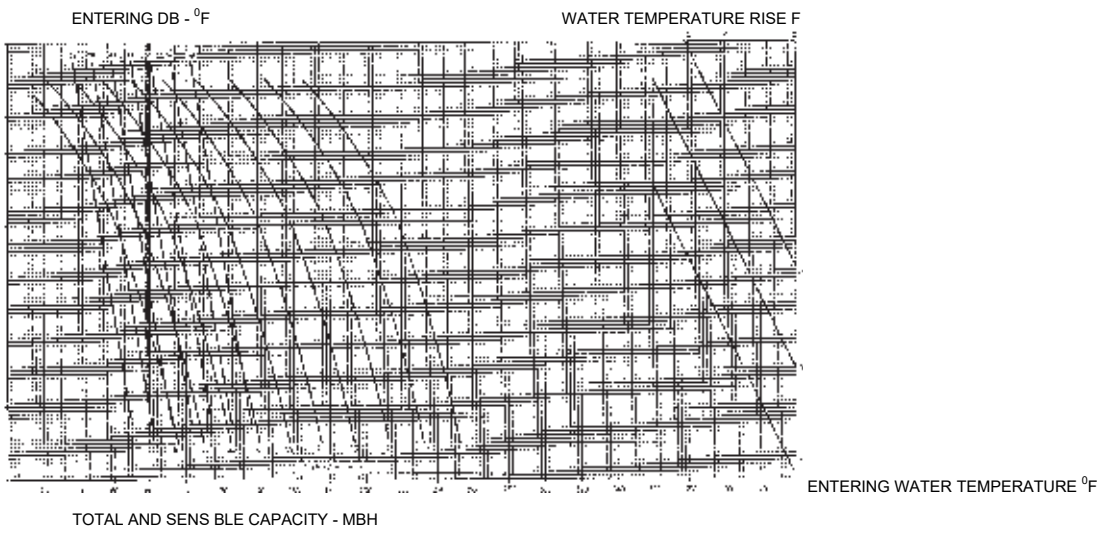

Fan Performance Curve

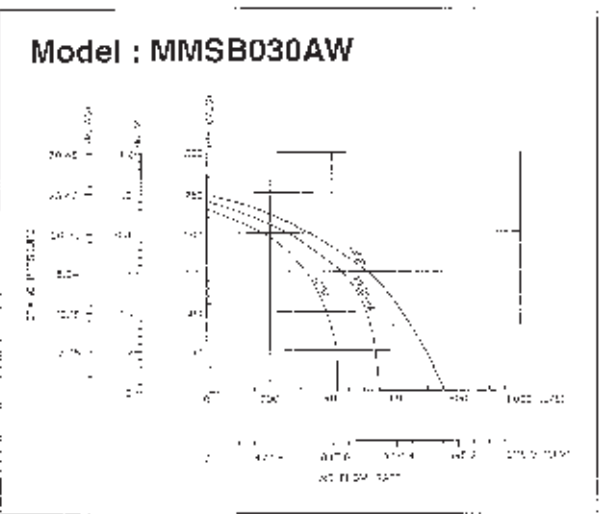
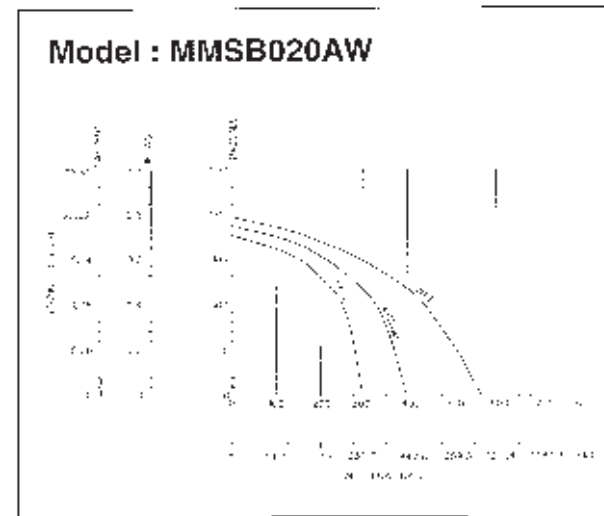
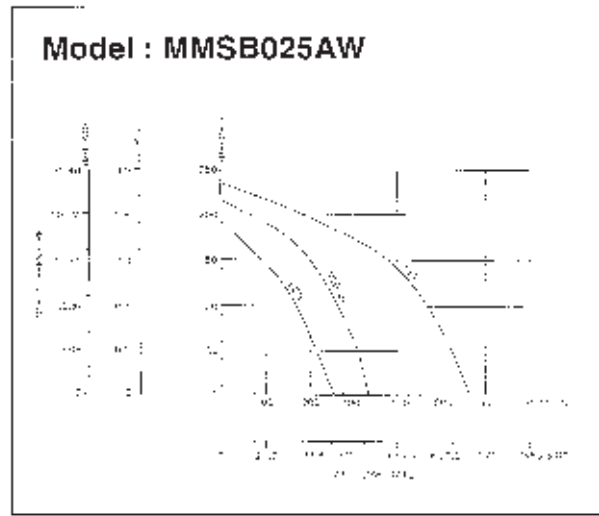
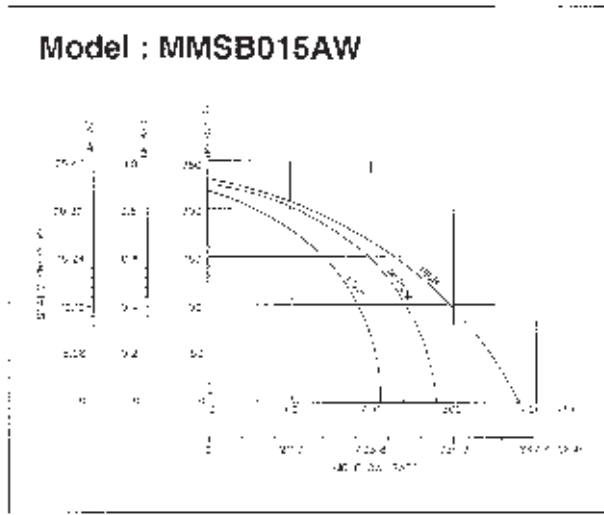
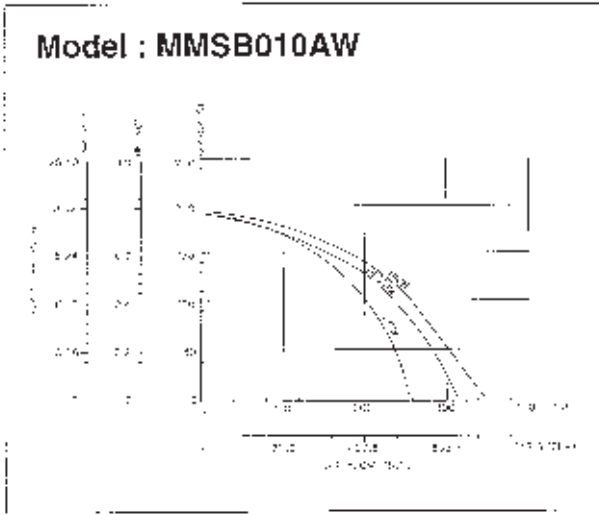

Model : MHSB030AW

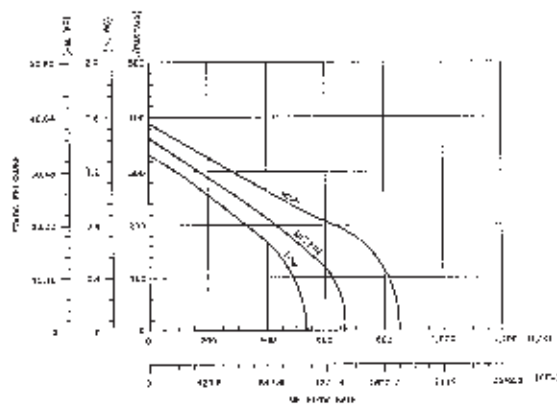

Model : MHSB040AW

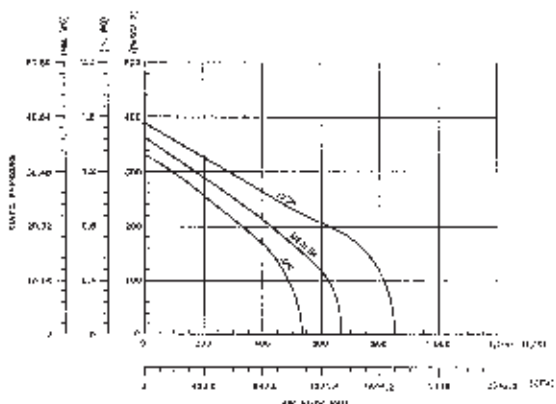

Model : MHSB050AW

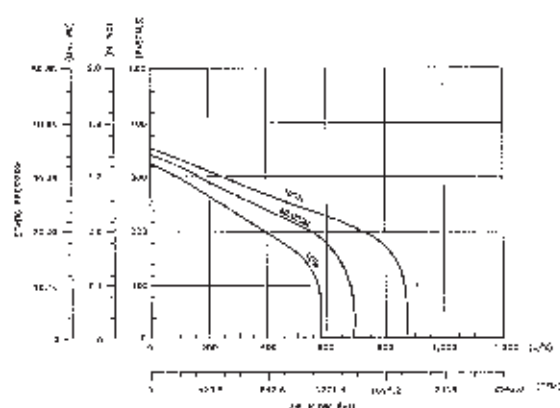

Model : MHSB060AW

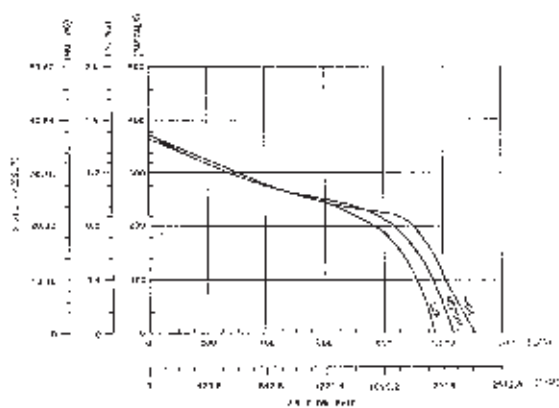

Model: MDB040BW
(Single Blower)

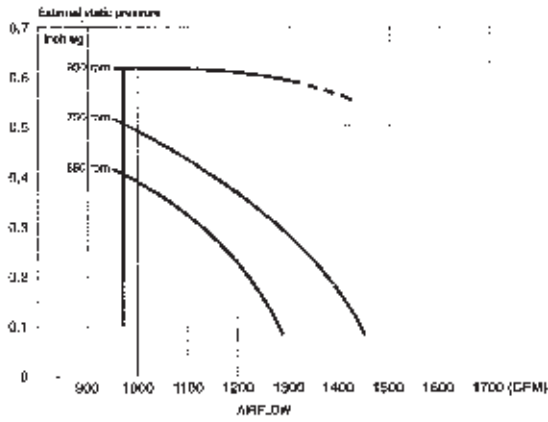

Model: MDB050BW
(Single Blower)

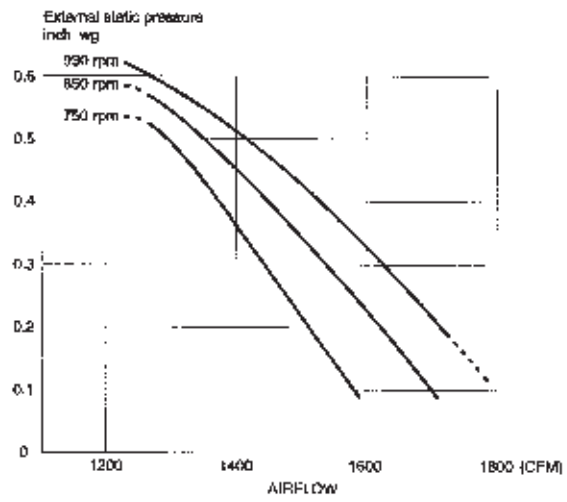

Model: MDB060BW, 075BW
(Double Blowers)

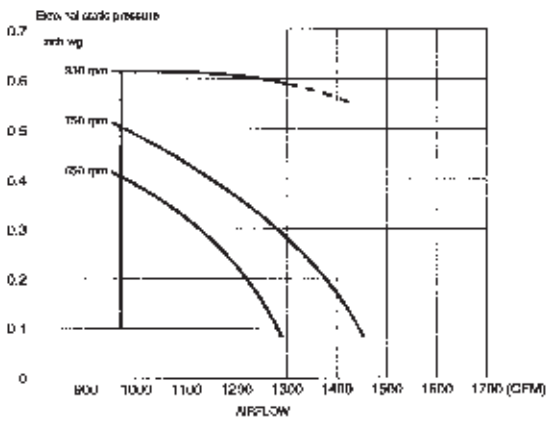

Model: MDB100BW
(Double Blowers)

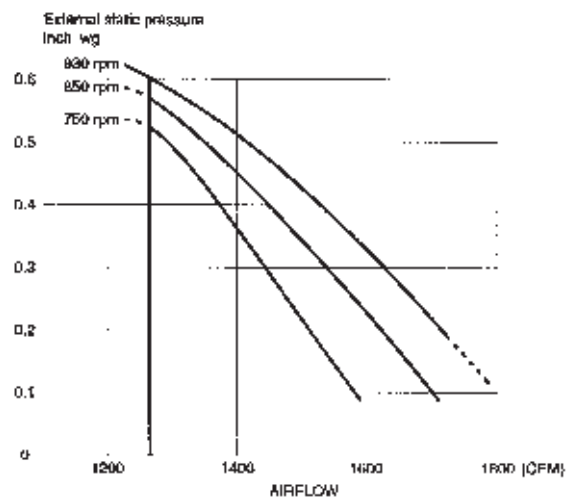

Wiring Diagrams

Model: MMSB010AW, 015AW, 020AW, 025AW, 030AW

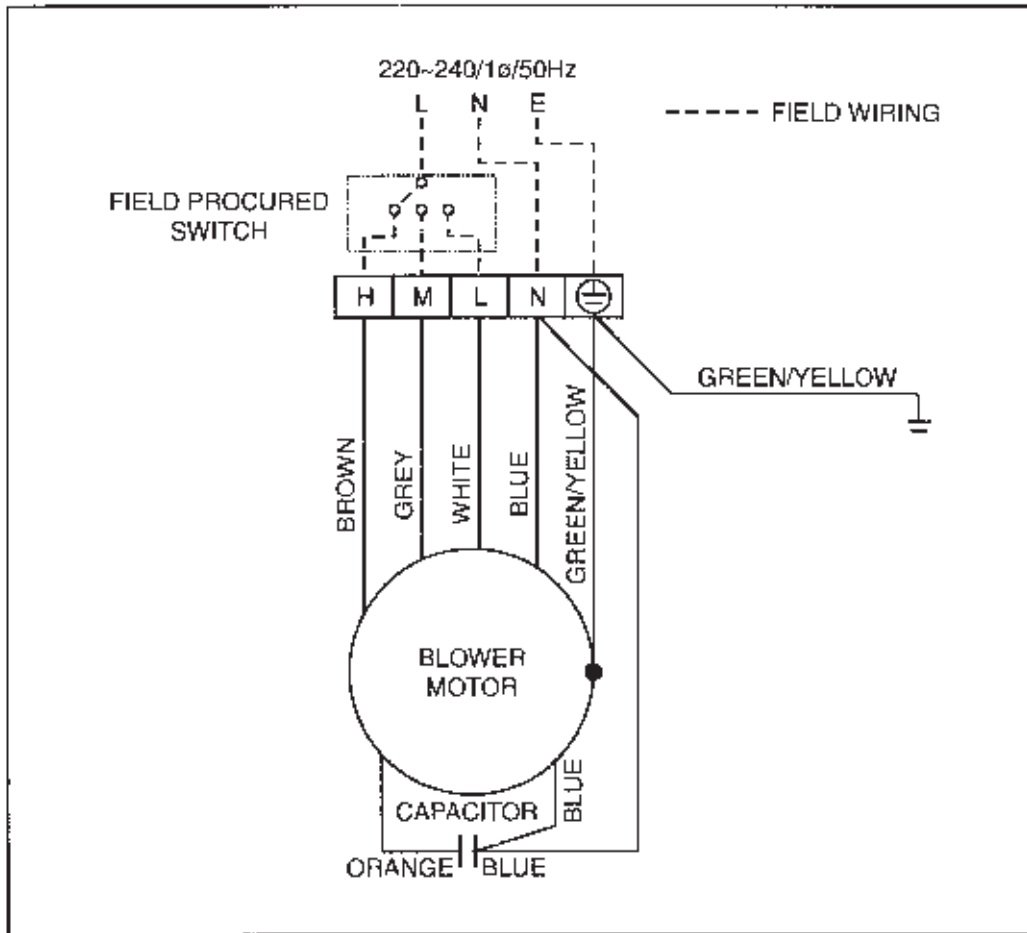

Model : MHSB030AW, 040AW

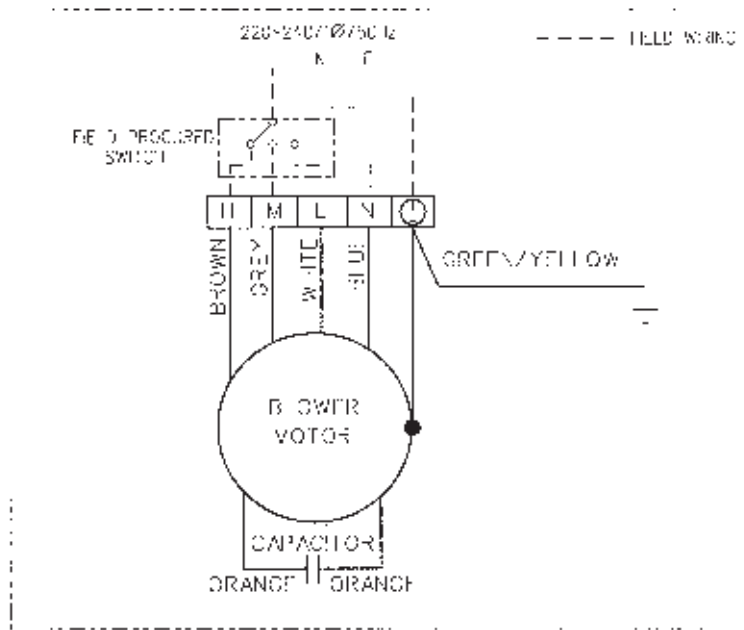

Model : MHSB050AW, 060AW

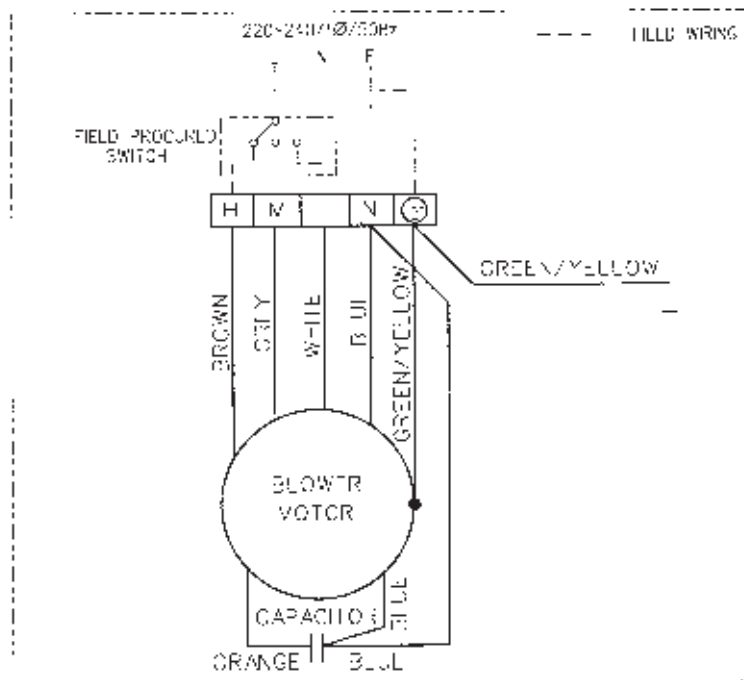

Model : MDB040BW, 050BW

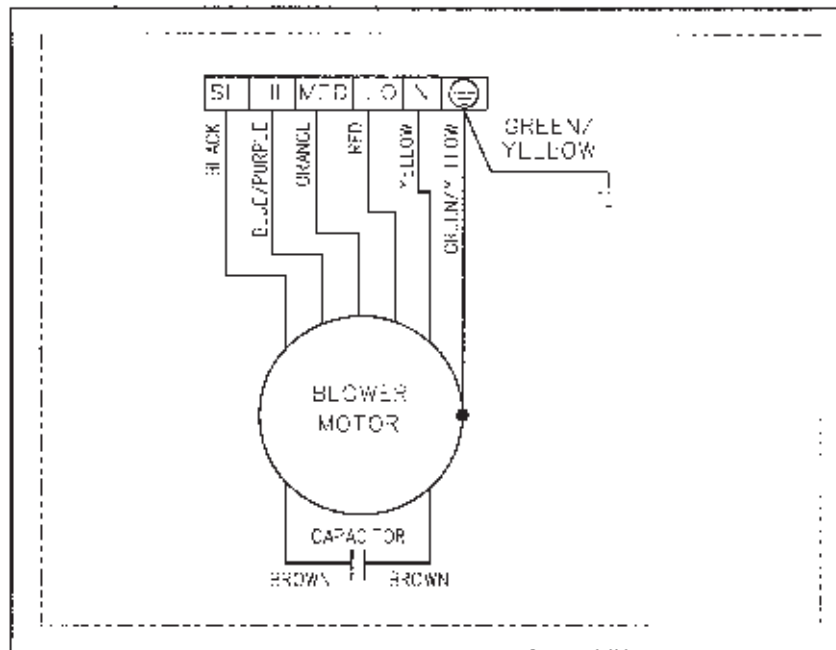

Model : MDB060BW, 075BW, 100BW

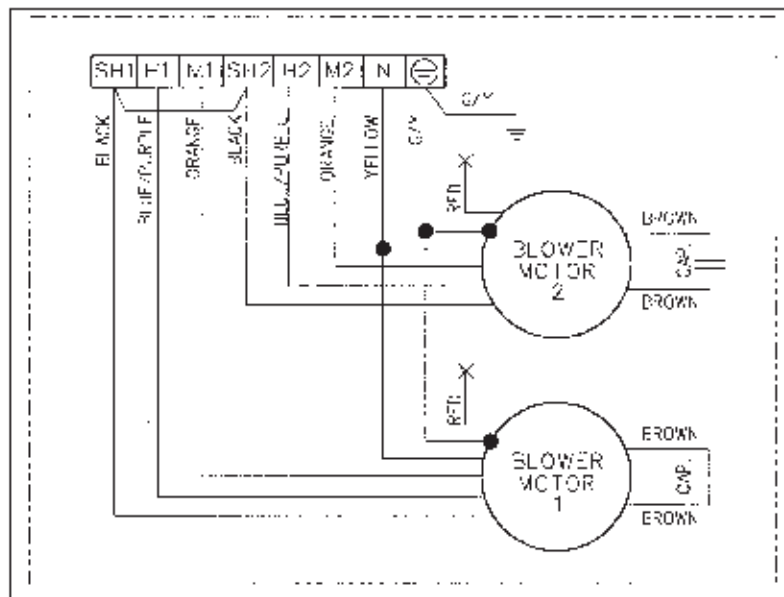

Outlines and Dimension

Medium Static Blower

Model: MMS010AW - 015AW

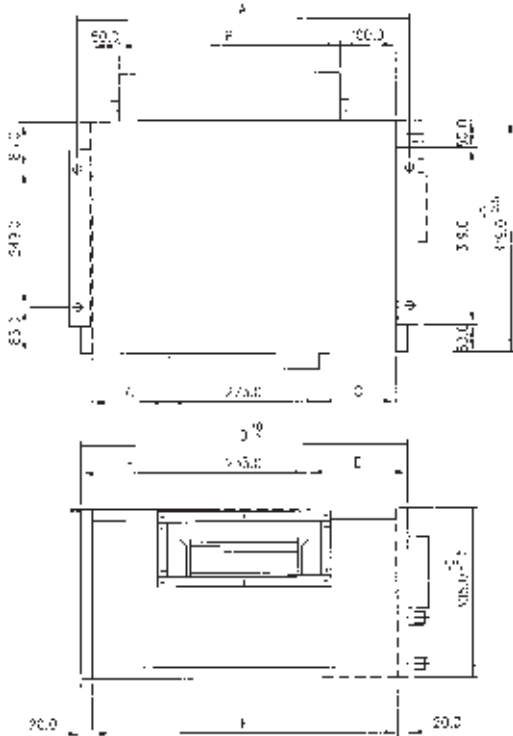

MODEL	A	B	C	D	E	F
MMSB 010AW	598.78	398.78	137.89	588.78	177.89	548.78
MMSB 015AW	796.90	596.90	236.95	786.90	276.95	746.90

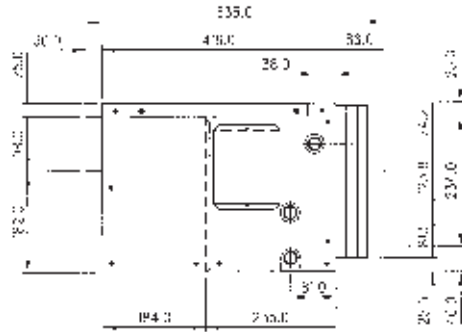

Model: MMSB020AW - 030AW

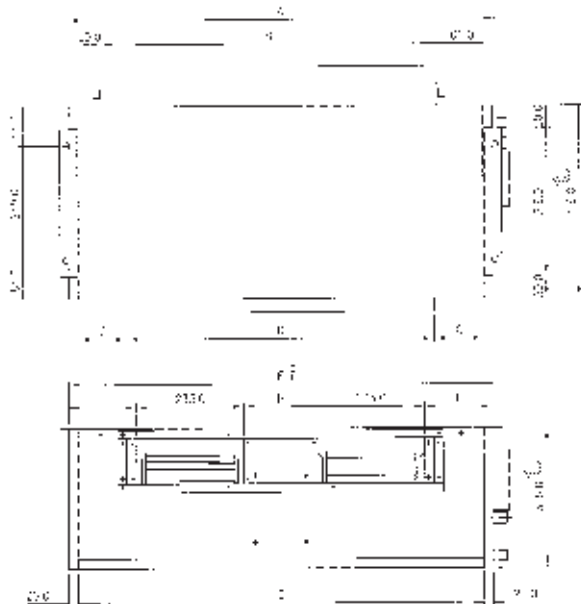

MODEL	A	B	C	D	E	F	G	H
MMSB 020AW	932.0	732.0	108.0	666.0	148.0	922.0	882.0	160.0
MMSB 025AW	1089.0	889.0	186.5	666.0	226.5	1079.0	1039.0	160.0
MMSB 030AW	1267.0	1067.0	242.5	732.0	282.5	1257.0	1217.0	226.0

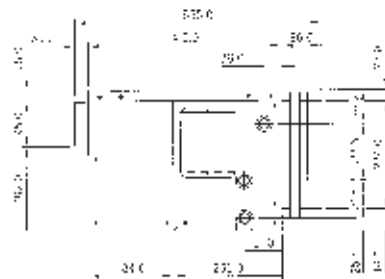

High Static Blower

Model: MHSB030AW - 060AW

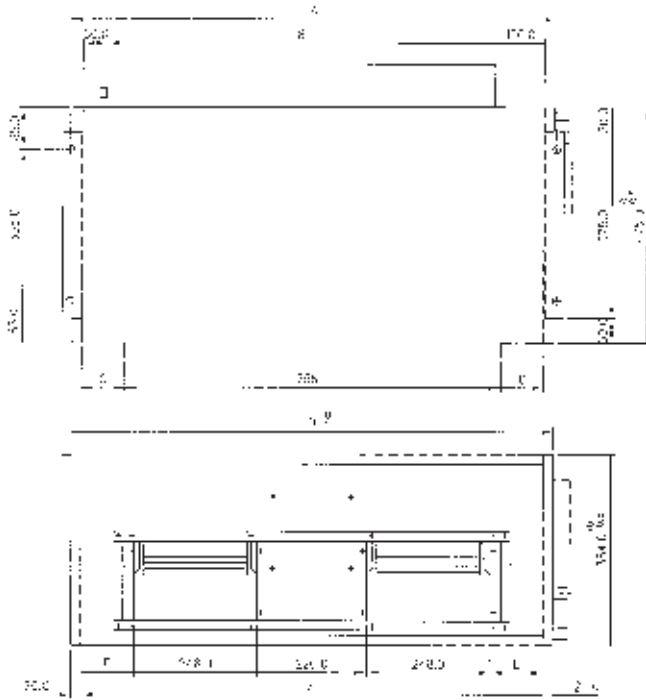

MODEL	A	B	C	D	E	F
MHSB030AW	980	780	87	970	107	930
MHSB040AW	1110	900	147	1090	167	1050
MHSB050AW	1350	1150	272	1340	292	1300
MHSB060AW	1550	1350	372	1540	392	1500

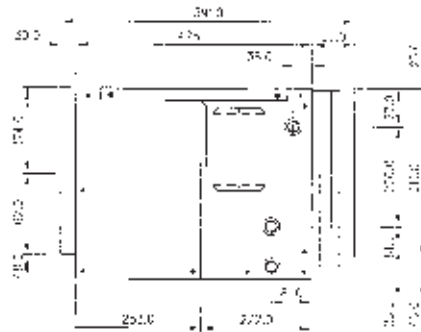

Model: MDB040BW - 050BW

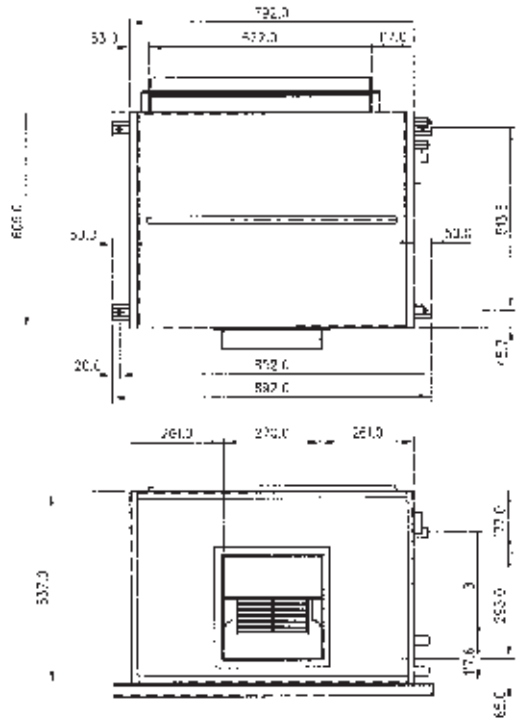

MODEL	A	F
DB 400W	12	3015
DB 500W	24	3901

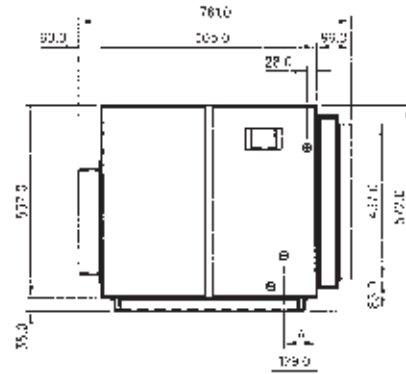

Model : MDB060BW - 100BW

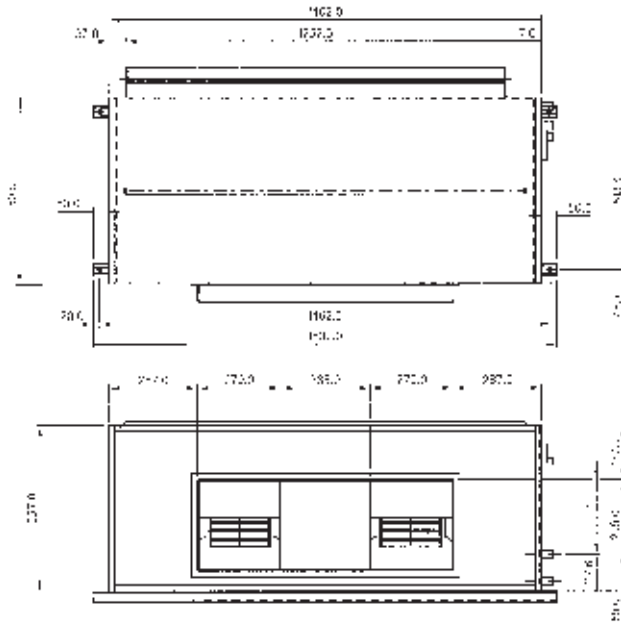

MODEL	A	F
DB 600W (150)	12	3901
DB 600W (100)	24	4801

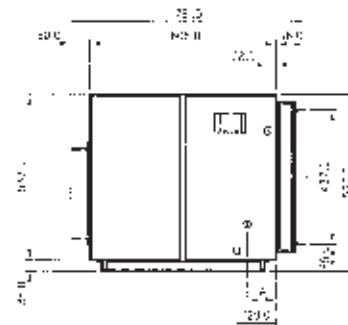

Parts List & Exploded View

Model: MMSB 010AW / 015AW

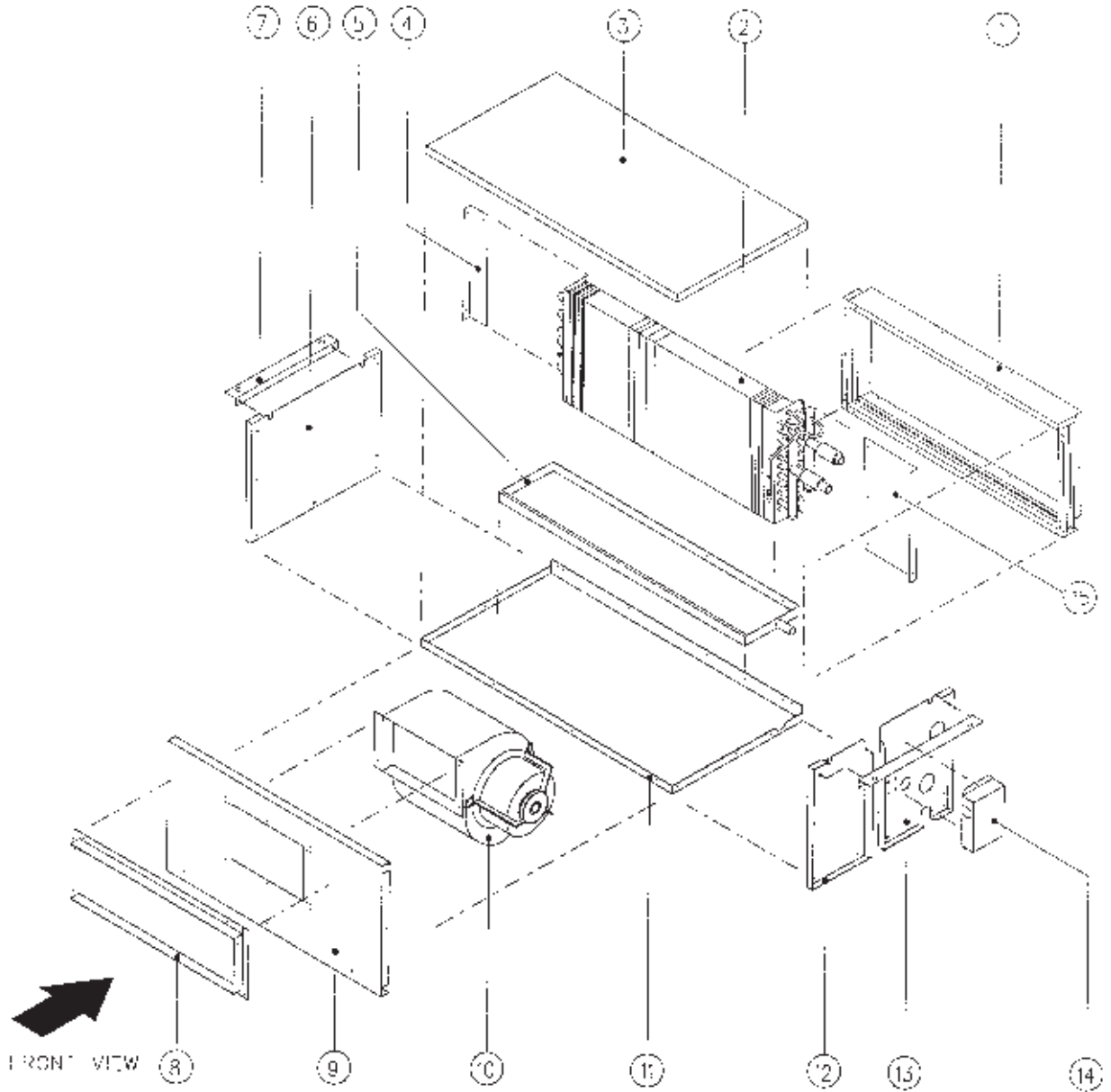

01.	Filter Flange Assy.	09.	Blower Panel
02.	Coil Piping Assy.	10.	Blower Housing & Motor Assy.
03.	Top Panel Assy.	11.	Base Panel
04.	Coil Side Cover Left	12.	Service Panel
05.	Drain Pan Assy.	13.	Side Panel Right
06.	Side Panel Left	14.	Junction Box
07.	Hanger Bracket	15.	Coil Side Cover Right
08.	Blower Flange Assy.		

Model: MMSB020AW / 025AW / 030AW

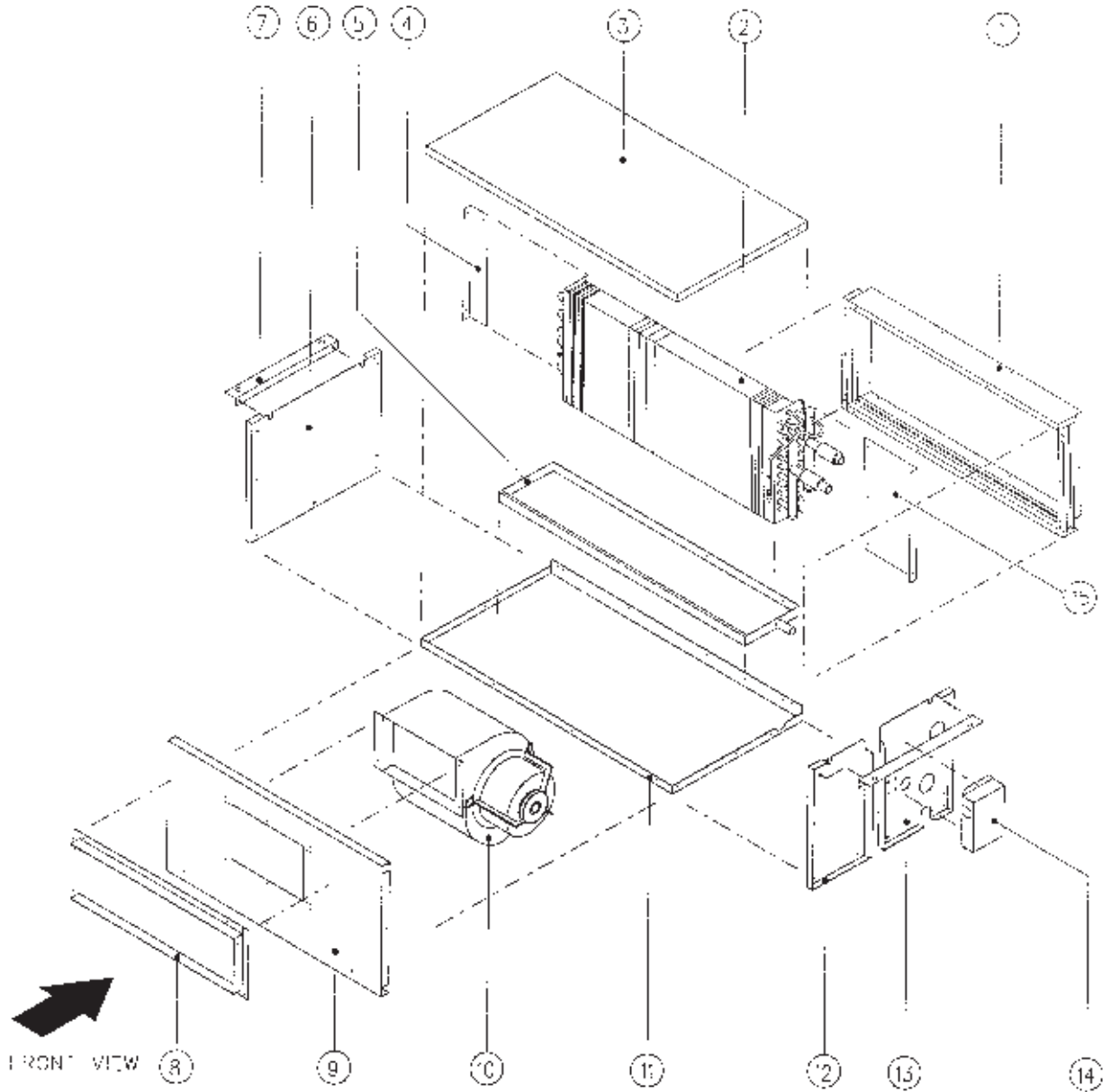

01. Filter Flange Assy.	09. Blower Panel
02. Coil Piping Assy.	10. Blower Housing & Motor Assy.
03. Top Panel Assy.	11. Base Panel
04. Coil Side Cover Left	12. Service Panel
05. Drain Pan Assy.	13. Side Panel Right
06. Side Panel Left	14. Junction Box
07. Hanger Bracket	15. Coil Side Cover Right
08. Blower Flange Assy.	

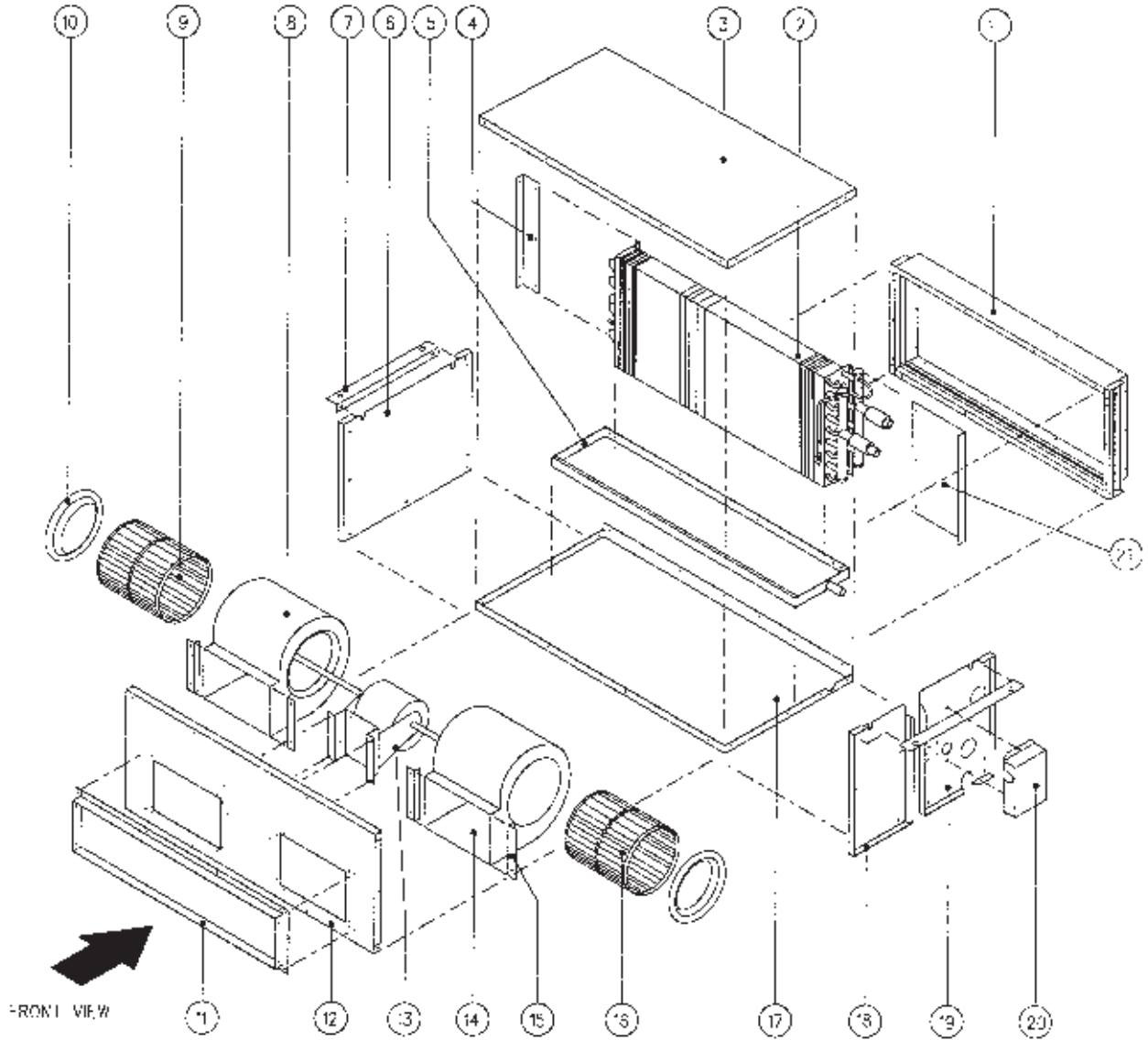

01. Filter Flange Assy.	12. Blower Panel Assy.
02. Coil Piping Assy.	13. Fan Motor Assy.
03. Top Panel Assy.	14. Blower Housing Right
04. Coil Side Cover Left	15. Blower Housing Support
05. Drain Pan Assy.	16. Blower Wheel Right
06. Side Panel Left	17. Base Panel
07. Hanger Bracket	18. Service Panel
08. Blower Housing Left	19. Side Panel Right
09. Blower Wheel Left	20. Junction Box
10. Bell Mount	21. Coil Side Cover Right
11. Blower Flange Assy.	

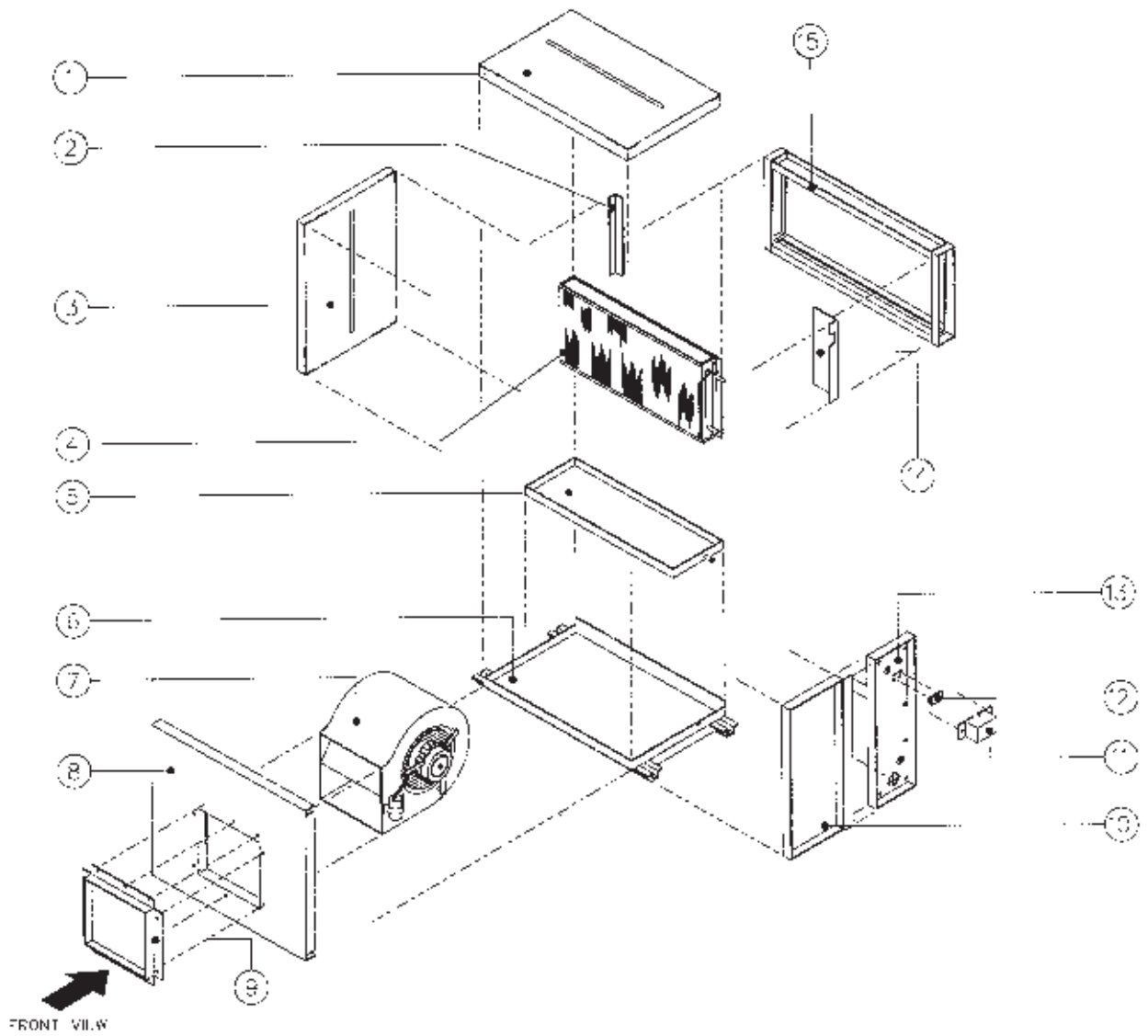

01. Top Panel	09. Blower Flange Assy.
02. Coil Side Cover	10. Side Panel Right Big
03. Top Panel Left	11. Terminal Cover
04. Coil Assy.	12. Terminal Block 20A, 6 Poles
05. Drain Pan Assy.	13. Side Panel Right Small
06. Base Pan Assy.	14. Coil Side Cover Right
07. Blower Housing & Motor Assy.	15. Blower Housing & Motor Assy.
08. Front Panel Assy.	

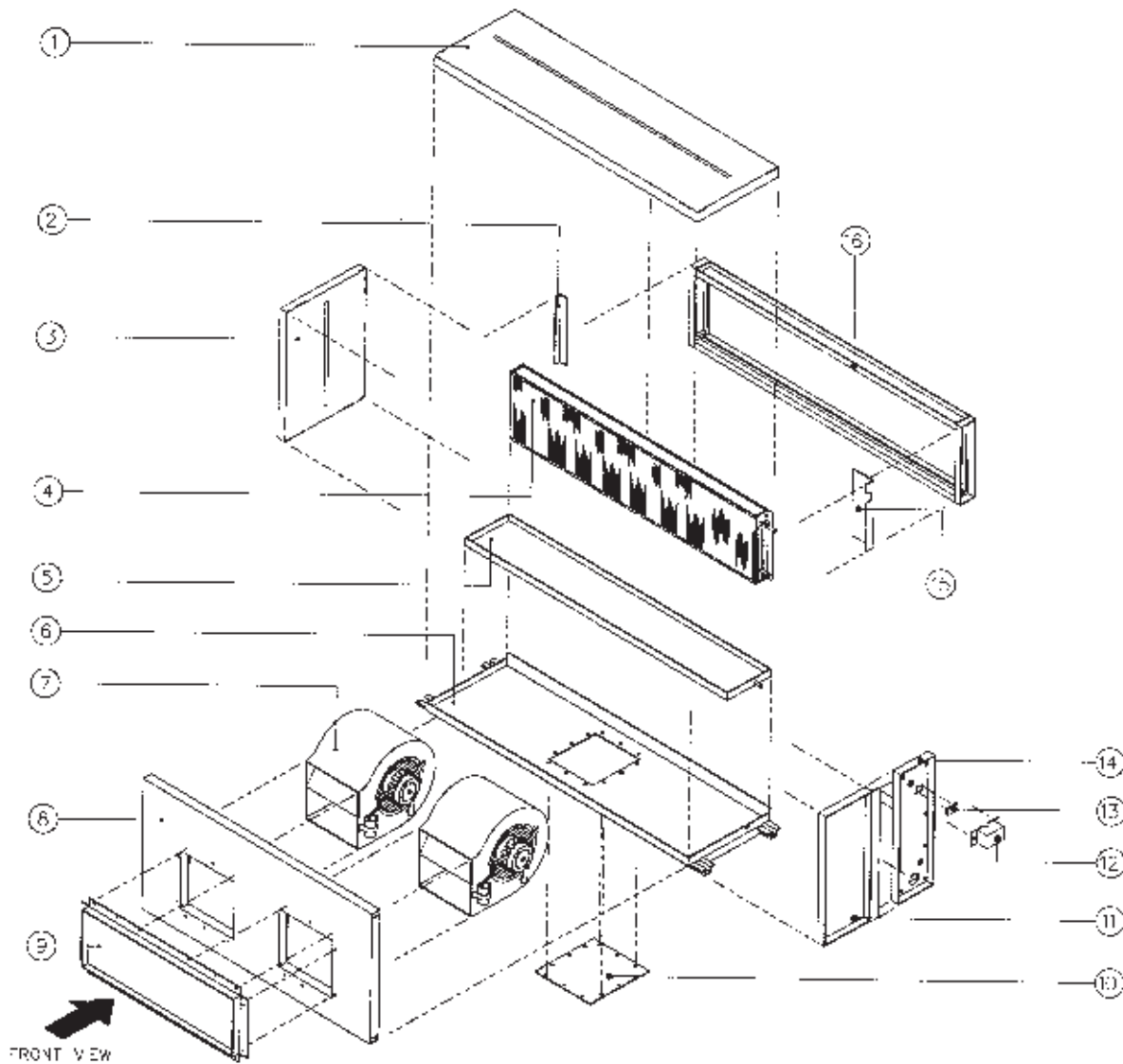

01.	Top Panel	09.	Blower Flange Assy.
02.	Coil Side Cover Left	10.	Base Panel Cover
03.	Side Panel Left	11.	Side Panel Right Big
04.	Coil Assy.	12.	Terminal Cover
05.	Drain Pan Assy.	13.	Terminal Block 20A, 8 Poles
06.	Base Pan Assy.	14.	Side Panel Right Small
07.	Blower Housing & Motor Assy.	15.	Coil Side Cover Right
08.	Front Panel Assy.	16.	Filter Section Assy

Installation

Preliminary Site Survey

Electrical supply and installation is to conform to LOCAL AUTHORITY's (e.g. National Electricity Board) CODES and REGULATIONS.

Voltage supply fluctuation must not exceed $\pm 10\%$ of rated voltage. Electricity supply lines must be independent of welding transformers which can cause supply fluctuation.

Ensure that the location is convenient for wiring and piping.

Mounting

For ceiling mounted models, locate a position where piping and ducting work can be kept to a minimum. Ensure that overhead supports are strong enough to hold the unit's weight. Position hanger rods and check for alignment with the unit. Check that hangers are secure and that the base of fan coil unit is level in two horizontal positions.

Piping

Drain and water piping must be accurately connected.

Please refer to "Specification Sheet" for piping sizes.

Piping Support

All water mains must be adequately supported to carry the necessary weight involved, provisions must be made by the installing contractor to allow for adequate free movement of all vertical and horizontal risers and run outs. Due to the fact that cold water will be circulated through the water mains, a sizeable movement of the water mains can be expected due to contraction. If for example, the piping is rigidly supported with no provision for movement, it is very possible that the tubing of fitting may be broken causing water leakage in the conditioned spaces throughout the building.

Coil Venting

Each standard basic unit coil is equipped with a manually operated air vent which is installed at the end of a small copper line leading into the highest point of the coil. By means of this valve, air may be vented manually, from the coil to keep it operating at full capacity. When water is first introduced into a coil, air is sometimes trapped in the coil tubing. This trapped air will reduce cooling capacity and create "Bubbling" or "Clanking" noise within the units. To release air trapped in the coil, press the air vent head to allow air to flow out of the air vent opening. Release when a steady stream of water appear.

Electrical Connection

As wiring regulations differ from country to country, please refer to your LOCAL ELECTRICAL CODES for field wiring regulations and ensure that they are complied with. Besides, take note of the following general precaution:

- 1) Ensure that the rated voltage of the unit corresponds to the name plate before commencing wiring work.
- 2) Provide a power outlet to be used exclusively for each unit and a power supply disconnect and a circuit-breaker for over-current protection should be provided in the exclusive line.
- 3) The unit must be EARTH to prevent possible hazards due to insulation failure.
- 4) All wiring must be firmly connected.

Operation

Start-up

The following procedure must be completed before any attempts is made to put the entire system Into operation:

- 1) Piping connections completed.
- 2) Electrical connections completed.
- 3) Duct connections completed.
- 4) Auxiliary drain pans in position where required.
- 5) Drain line draining into drain pans.
- 6) Filters correctly installed and free of construction debris.
- 7) Motor-blower assembly rotates freely.
- 8) Unit Hydrostatically tested and air vented.

Starting The Fan Coil Unit

- 1) Turn on the switch of water pump.
- 2) Start water chiller.
- 3) Operate the fan coil unit by turning on the fan and set the control switch to get the desired speed.
- 4) Inspect the duct and piping condition and rectify problem (e.g. vibration, noise, etc.) if exist.

Servicing and Maintenance

Fan coil units are designed to operate continuously with minor routine maintenance. Since fan coil units cool the discharging forced air, the efficiency with which the units operate is directly related to the amount of air passing through the coil.

Air Filters

The function of the air filters is to remove foreign matter such as dirt, soot, pollen and certain other impurities from the air passing through it. A clogged or dirty filter not only fails to do the job for which it is designed, but restricts the flow of air over the coil.

The importance of cleaning the filter before it becomes clogged must be greatly stressed. The frequency with which a filter should be cleaned will depend upon the amount of dust and foreign material that enters a unit, and this depends upon location and situation.

The washable viledon or saranet filter may be cleaned by tapping the filter on a solid surface to dislodge heavy particles. Wash under stream of warm water, with detergent if necessary. Dry it thoroughly before replacing.

Fan Motor

The fan motor is prelubricated and sealed at the factory. Therefore, no lubricating maintenance is required.

Coils

Clean coil unit by brushing between fins with a nylon brush. Brushing should be followed by cleaning with a vacuum cleaner. The coil may also be cleaned by using a high pressure air hose and nozzle if a compressed air source is available. It should be pointed out that if suitable air filter is used and taken care of properly, the coils need no cleaning.

Drain Pipe

The drain pipe should be checked before operation of unit is begun. If it is clogged, steps should be taken to clean the debris so that condensate will flow out easily.

Replacement of Parts

Replacement of parts are available through your local dealers. When ordering parts, you must supply

- 1) Model name of the unit.
- 2) Serial number of the unit.
- 3) Part name and number.



Americas - 13600 Industrial Park Boulevard, P.O. Box 1551, Minneapolis, MN 55440 USA (612) 553-5330
Asia - Jalan Pengapit 15/19, P.O. Box 7072, 40702 Shah Alam, Selangor Darul Eshan, Malaysia - Tel: 6-03-5594922 - Fax: 6-03-5506980 - Telex: MA 38521
Europe - 42 Cours Jean Jaurès - 17800 Pons - France - Tél: (33) 46 92 33 33 - Téléx: 790 536 F - Télécopie: (33) 46 91 38 33



Printed on recycled paper containing at least 10% post consumer recycled material.

Printed on April 1998