

VERBINDUNGSTECHNIK

Gewindefittings aus Messing
(nach DIN 50930-6)
mit Befestigungsgewinden
nach DIN EN ISO 228

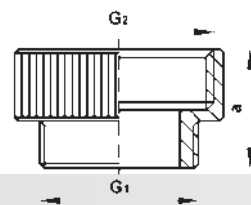

РОСС DE.АЮ.Н06241



Katalog-Nr. und -bezeichnung

1542 – Übergangstück rund, verchromt, mit Innen- und Außengewinde (Europanippel)

Artikel-Nr.	Abmessung G1 x G2	Beutel	Karton	EAN-Code-Nr.	a
215421234C*	1/2a x 3/4i	10	350	4021343036903	19
2154212221C*	1/2a x M22 x 1i	10	600	4021343036897	16
2154234M221C*	3/4a x M22 x 1i	10	500	4021343036941	14
215423412221C*	3/4a x 1/2i x M22 x 1i	10	800	4021343036965	10

* nur noch aus Lagervorrat lieferbar.

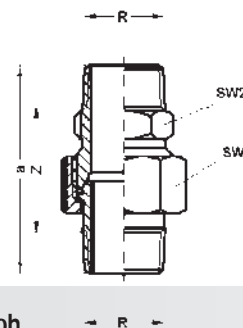

Katalog-Nr. und -bezeichnung

221 – Eisenrohrverschraubung, konisch dichtend, beidseitig mit Außengewinde nach DIN EN 10226, roh

Artikel-Nr.	Abmessung R	Beutel	Karton	EAN-Code-Nr.	a	z	SW1	SW2
222138R	3/8	5	150	4021343039089	52	32	24	22
222112R	1/2	5	100	4021343039058	62	36	30	27
222134R	3/4	5	50	4021343039072	72	42	37	34
222111R	1	5	30	4021343039027	73	42	46	34
2221114R	1 1/4	5	30	4021343039041	91	58	52	46
2221112R	1 1/2	5	20	4021343039034	98	58	59	50
22212R	2	2	10	4021343039065	113	65	75	60

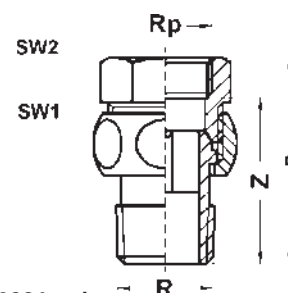

Katalog-Nr. und -bezeichnung

222 – Eisenrohrverschraubung, konisch dichtend, mit Innen- und Außengewinde nach DIN EN 10226, roh

Artikel-Nr.	Abmessung Rp x R	Beutel	Karton	EAN-Code-Nr.	a	z	SW1	SW2
222238R	3/8	5	150	4021343039157	47	37	24	22
222212R	1/2	5	120	4021343039126	47	38	30	26

Katalog-Nr. und -bezeichnung

222 – Eisenrohrverschraubung, konisch dichtend, mit Innen- und Außengewinde nach DIN EN 10226, roh (Fortsetzung)

Artikel-Nr.	Abmessung Rp x R	Beutel	Karton	EAN-Code-Nr.	a	z	SW1	SW2
222234R	3/4	5	60	4021343039140	63	49	37	34
22221R	1	5	40	4021343039096	68	51	46	37
2222114R	1 1/4	5	20	4021343039119	75	56	52	46
2222112R	1 1/2	5	15	4021343039102	81	62	59	54
22222R	2	2	10	4021343039133	91	67	75	66

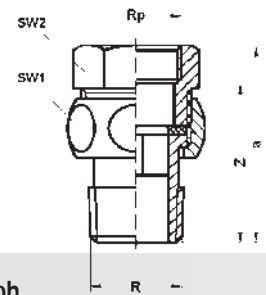

Katalog-Nr. und -bezeichnung

223 – Eisenrohrverschraubung, flachdichtend, mit Innen- und Außengewinde nach DIN EN 10226, roh

Artikel-Nr.	Abmessung Rp x R	Beutel	Karton	EAN-Code-Nr.	a	z	SW1	SW2
222338R	3/8	5	150	4021343039225	47	37	24	22
222312R	1/2	5	120	4021343039195	49	40	30	26
222334R	3/4	5	60	4021343039218	59	44	37	32
22231R	1	5	40	4021343039164	66	49	46	41
2223114R	1 1/4	5	30	4021343039188	72	57	52	48
2223112R	1 1/2	5	20	4021343039171	81	62	59	54
22232R	2	2	10	4021343039201	91	66	75	66

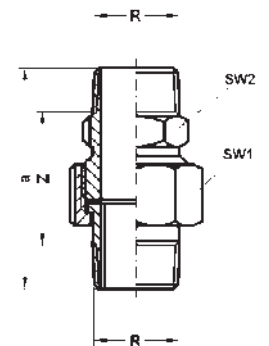

Katalog-Nr. und -bezeichnung

224 – Eisenrohrverschraubung, flachdichtend, beidseitig mit Außengewinde nach DIN EN 10226, roh

Artikel-Nr.	Abmessung R	Beutel	Karton	EAN-Code-Nr.	a	z	SW1	SW2
222438R*	3/8	5	150	4021343039416	52	32	24	22

* nur noch aus Lagervorrat lieferbar.

Katalog-Nr. und -bezeichnung

224 – Eisenrohrverschraubung, flachdichtend, beidseitig mit Außengewinde nach DIN EN 10226, roh (Fortsetzung)

Artikel-Nr.	Abmessung R	Beutel	Karton	EAN-Code-Nr.	a	z	SW1	SW2
222412R	1/2	5	100	4021343039263	60	34	30	22
222434R	3/4	5	50	4021343039409	67	37	37	27
22241R	1	5	30	4021343039232	76	42	46	34
2224114R	1 1/4	5	30	4021343039256	96	58	52	46
2224112R	1 1/2	5	20	4021343039249	98	58	59	50
22242R	2	2	10	4021343039270	113	65	75	60

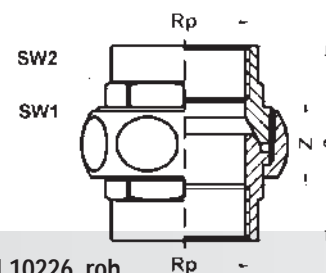

Katalog-Nr. und -bezeichnung

271 – Eisenrohrverschraubung, konisch dichtend, beidseitig mit Innengewinde nach DIN EN 10226, roh

Artikel-Nr.	Abmessung Rp	Beutel	Karton	EAN-Code-Nr.	a	z	SW1	SW2
227114R	1/4	5	100	4021343041303	43	23	26	-
227138R	3/8	5	100	4021343041341	46	26	30	22
227112R	1/2	5	80	4021343041297	48	21	37	26
227134R	3/4	5	50	4021343041334	52	22	46	30
22711R	1	5	40	4021343041266	57	23	52	40
2271114R	1 1/4	5	20	4021343041280	64	26	64	50
2271112R	1 1/2	5	15	4021343041273	70	32	72	54
22712R	2	2	10	4021343041327	79	31	89	-

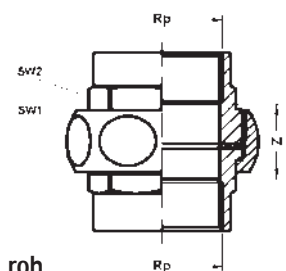

Katalog-Nr. und -bezeichnung

272 – Eisenrohrverschraubung, flachdichtend, beidseitig mit Innengewinde nach DIN EN 10226, roh

Artikel-Nr.	Abmessung Rp	Beutel	Karton	EAN-Code-Nr.	a	z	SW1	SW2
227214R	1/4	5	100	4021343041396	43	23	26	-
227238R*	3/8	5	100	4021343041433	46	26	30	22
227212R	1/2	5	80	4021343041389	48	21	37	26
227234R	3/4	5	50	4021343041426	52	22	46	30
22721R	1	5	40	4021343041358	57	23	52	40
2272114R	1 1/4	5	20	4021343041372	64	26	64	50
2272112R	1 1/2	5	15	4021343041365	70	34	72	54
22722R	2	2	10	4021343041419	78	30	89	-

* nur noch aus Lagervorrat lieferbar.

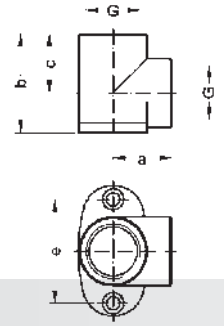

Katalog-Nr. und -bezeichnung
421 – Wandscheibe für Eisenrohr, mit Innengewinde, verchromt und roh

Artikel-Nr.	Abmessung G	Beutel	Karton	EAN-Code-Nr.	a	b	c	e
roh								
242138R*	3/8	10	120	4021343042713	20	34	19	40
242112R	1/2	10	90	4021343042676	23	38	23	40
242134R	3/4	10	60	4021343042690	26	44	26	45
verchromt								
242138C*	3/8	10	120	4021343042706	20	34	19	40
242112C	1/2	10	90	4021343042669	23	38	23	40
242134C*	3/4	10	60	4021343042683	26	44	26	45

* nur noch aus Lagervorrat lieferbar.

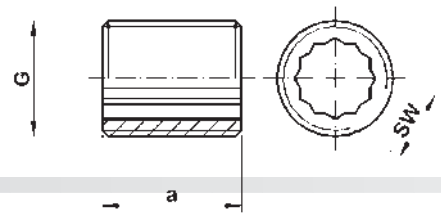

Katalog-Nr. und -bezeichnung
521 – Rohrnickel, mit Außengewinde, verchromt und roh

Artikel-Nr.	Abmessung G	Beutel	Karton	EAN-Code-Nr.	a	SW
roh						
252118R	1/8	10	2000	4021343044281	20	-
252114R	1/4	10	1300	4021343044267	20	-
252138R	3/8	10	800	4021343044342	20	10
252112R	1/2	10	400	4021343044243	25	12
252134R	3/4	10	200	4021343044328	26	17
25211R	1	10	100	4021343044182	33	22
2521114R	1 1/4		90	4021343044229	38	-
2521112R	1 1/2		65	4021343044205	38	-
25212R	2		36	4021343044304	44	-
verchromt						
252114C*	1/4	10	1300	4021343044250	20	-
252138C*	3/8	10	800	4021343044335	20	10
252112C*	1/2	10	400	4021343044236	25	12
25211C*	1	10	100	4021343044175	33	22
2521114C *	1 1/4		90	4021343044229	38	

* nur noch aus Lagervorrat lieferbar.

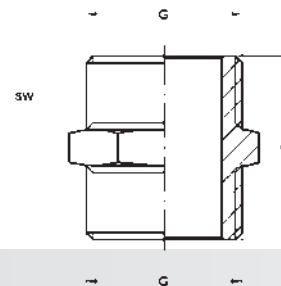

Katalog-Nr. und -bezeichnung

522 – Doppelnippel mit Sechskant, beidseitig mit Außengewinde, verchromt und roh

Artikel-Nr.	Abmessung G	Beutel	Karton	EAN-Code-Nr.	a	SW
roh						
252218R	1/8	10	1500	4021343044465	20	10
252214R	1/4	10	900	4021343044441	20	14
252238R	3/8	10	600	4021343044571	22	17
252212R	1/2	10	350	4021343044427	24	22
252234R	3/4	10	250	4021343044557	26	27
25221R	1	10	150	4021343044366	28	34
2522114R	1 1/4		90	4021343044403	34	42
2522112R	1 1/2		60	4021343044380	40	50
25222R	2		30	4021343044489	44	60
25223R*	3		12	4021343044533	61	90
verchromt						
252218C	1/8	10	1500	4021343044458	20	10
252214C	1/4	10	900	4021343044434	20	14
252238C	3/8	10	600	4021343044564	22	17
252212C	1/2	10	350	4021343044410	24	22
252234C	3/4	10	250	4021343044540	26	27
25221C	1	10	150	4021343044359	28	34
2522114C	1 1/4		90	4021343044397	34	42
2522112C	1 1/2		60	4021343044373	40	50
25222C	2		30	4021343044472	44	60

* nur noch aus Lagervorrat lieferbar.

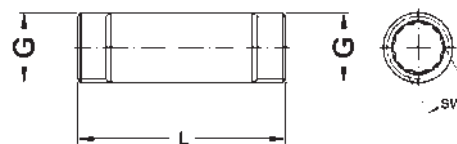

Katalog-Nr. und -bezeichnung

523 – Rohrdoppelnippel, beidseitig mit Außengewinde, verchromt und roh

Artikel-Nr.	Abmessung G x L	Beutel	Karton	EAN-Code-Nr.	L	SW
roh						
25233840R	3/8 x 40	10	500	4021343045929	40	10
25233850R	3/8 x 50	10	350	4021343045943	50	10
25233860R	3/8 x 60	10	300	4021343045967	60	10
25233880R	3/8 x 80	10	200	4021343045981	80	10
25231230R	1/2 x 30	10	350	4021343045202	30	12
25231240R	1/2 x 40	10	300	4021343045226	40	12
25231250R	1/2 x 50	10	250	4021343045240	50	12
25231260R	1/2 x 60	10	200	4021343045264	60	12
25231280R	1/2 x 80	10	120	4021343045288	80	12
252312100R	1/2 x 100	10	90	4021343045066	100	12
252312120R	1/2 x 120		90	4021343045080	120	12

Artikel-Nr.	Abmessung G x L	Beutel	Karton	EAN-Code-Nr.	L	SW
252312150R	1/2 x 150		80	4021343045127	150	12
252312200R	1/2 x 200		70	4021343045189	200	12
25233430R	3/4 x 30	10	220	4021343045653	30	17
25233440R	3/4 x 40	10	150	4021343045677	40	17
25233450R	3/4 x 50	10	150	4021343045691	50	17
25233460R	3/4 x 60	10	120	4021343045714	60	17
25233480R	3/4 x 80	10	90	4021343045738	80	17
252334100R	3/4 x 100	10	60	4021343045516	100	17
252334120R	3/4 x 120		60	4021343045530	120	17
252334150R	3/4 x 150		60	4021343045578	150	17
252334160R*	3/4 x 160		40	4021343181313	160	17
252334180R*	3/4 x 180		40	4021343181320	180	17
252334200R	3/4 x 200		40	4021343045639	200	17
2523130R	1 x 30	10	120	4021343045301	30	22
2523140R	1 x 40	10	100	4021343045325	40	22
2523150R	1 x 50	10	90	4021343045349	50	22
2523160R	1 x 60	10	70	4021343045363	60	22
2523180R	1 x 80	10	60	4021343045387	80	22
25231100R	1 x 100	10	40	4021343044595	100	22
25231120R	1 x 120		50	4021343044618	120	22
25231150R	1 x 150		36	4021343044984	150	22
25231200R	1 x 200		20	4021343045042	200	22
252311440R	1 1/4 x 40		80	4021343044908	40	-
252311460R	1 1/4 x 60		50	4021343044946	60	-
252311480R	1 1/4 x 80		40	4021343044960	80	-
2523114100R	1 1/4 x 100		38	4021343044762	100	-
2523114120R	1 1/4 x 120		32	4021343044786	120	-
2523114150R	1 1/4 x 150		28	4021343044823	150	-
2523114200R	1 1/4 x 200		16	4021343044885	200	-
252311240R	1 1/2 x 40		60	4021343044694	40	-
252311260R	1 1/2 x 60		48	4021343044717	60	-
252311280R	1 1/2 x 80		36	4021343044724	80	-
2523112100R	1 1/2 x 100		30	4021343044625	100	-
2523112120R	1 1/2 x 120		24	4021343044632	120	-
2523112150R	1 1/2 x 150		20	4021343044656	150	-
2523112200R	1 1/2 x 200		10	4021343044687	200	-
2523240R*	2 x 40		30	4021343045462	40	-
2523260R	2 x 60		24	4021343045486	60	-
2523280R	2 x 80		20	4021343045493	80	-
25232100R	2 x 100		15	4021343045394	100	-
25232120R	2 x 120		12	4021343045400	120	-
25232150R	2 x 150		12	4021343045424	150	-
25232160R*	2 x 160		8	4021343045431	160	-
verchromt						
25233840C	3/8 x 40	10	500	4021343045912	40	10
25233860C	3/8 x 60	10	300	4021343045950	60	10
25233880C	3/8 x 80	10	200	4021343045974	80	10
25231230C	1/2 x 30	10	350	4021343045196	30	12
25231240C	1/2 x 40	10	300	4021343045219	40	12
25231250C	1/2 x 50	10	250	4021343045233	50	12
25231260C	1/2 x 60	10	200	4021343045257	60	12
25231280C	1/2 x 80	10	120	4021343045271	80	12
252312100C	1/2 x 100	10	90	4021343045059	100	12
252312120C	1/2 x 120	10	90	4021343045073	120	12
252312150C	1/2 x 150	10	80	4021343045110	150	12
252312200C	1/2 x 200	10	70	4021343045172	200	12
25233430C*	3/4 x 30	10	220	4021343045646	30	17
25233440C	3/4 x 40	10	150	4021343045660	40	17
25233450C*	3/4 x 50	10	150	4021343045684	50	17
25233460C	3/4 x 60	10	120	4021343045707	60	17
25233480C	3/4 x 80	10	90	4021343045721	80	17
252334100C	3/4 x 100	10	60	4021343045509	100	17

* nur noch aus Lagervorrat lieferbar.

Katalog-Nr. und -bezeichnung

523 – Rohrdoppelnippel, beidseitig mit Außengewinde, verchromt und roh (Fortsetzung)

Artikel-Nr.	Abmessung G x L	Beutel	Karton	EAN-Code-Nr.	L	SW
252334120C	3/4 x 120		60	4021343045523	120	17
252334150C	3/4 x 150		60	4021343045561	150	17
252334200C	3/4 x 200		40	4021343045622	200	17
2523140C	1 x 40	10	100	4021343045318	40	22
2523160C	1 x 60	10	70	4021343045356	60	22
2523180C	1 x 80	10	60	4021343045370	80	22
25231100C	1 x 100	10	40	4021343044588	100	22
25231120C	1 x 120		50	4021343044601	120	22
25231150C	1 x 150		36	4021343044977	150	22

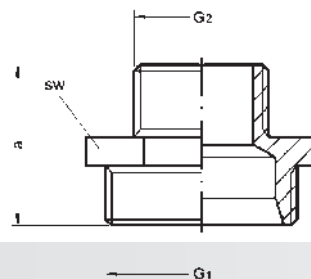

Katalog-Nr. und -bezeichnung

531 – Reduziernippel, beidseitig mit Außengewinde, verchromt und roh

Artikel-Nr.	Abmessung G1 x G2	Beutel	Karton	EAN-Code-Nr.	a	SW
roh						
25311418R	1/4 x 1/8	10	1000	4021343046209	20	14
25313814R	3/8 x 1/4	10	600	4021343046407	25	17
25311214R	1/2 x 1/4	10	350	4021343046117	27	22
25311238R	1/2 x 3/8	10	400	4021343046148	25	22
25313438R	3/4 x 3/8	10	300	4021343046377	28	27
25313412R	3/4 x 1/2	10	250	4021343046346	27	27
2531112R	1 x 1/2	10	150	4021343046025	30	34
2531134R	1 x 3/4	10	150	4021343046162	31	34
25311141R	1 1/4 x 1		70	4021343046070	32	42
2531112114R	1 1/2 x 1 1/4		50	4021343046049	40	50
25312112R	2 x 1 1/2		30	4021343046223	43	61
25312122R	2 1/2 x 2		18	4021343046247	48	62
verchromt						
25311418C	1/4 x 1/8	10	1000	4021343046193	20	14
25313814C	3/8 x 1/4	10	600	4021343046391	25	17
25311214C	1/2 x 1/4	10	350	4021343046100	27	22
25311238C	1/2 x 3/8	10	400	4021343046131	25	22
25313438C*	3/4 x 3/8	10	300	4021343046360	28	27
25313412C	3/4 x 1/2	10	250	4021343046339	27	27
2531112C	1 x 1/2	10	150	4021343046018	30	34
2531134C	1 x 3/4	10	150	4021343046155	31	34
25311141C	1 1/4 x 1		70	4021343046063	32	42
2531112114C	1 1/2 x 1 1/4		50	4021343046032	40	50

* nur noch aus Lagervorrat lieferbar.

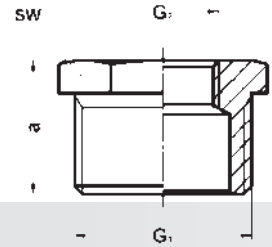

Katalog-Nr. und -bezeichnung

541 – Reduzierstück mit Sechskant, mit Innen- und Außengewinde, verchromt und roh

Artikel-Nr.	Abmessung G1 x G2	Beutel	Karton	EAN-Code-Nr.	a	SW
roh						
25411418R	1/4 x 1/8	10	1000	4021343046933	13	14
25413818R	3/8 x 1/8	10	800	4021343047251	14	17
25413814R	3/8 x 1/4	10	700	4021343047237	14	17
25411218R	1/2 x 1/8	10	500	4021343046858	16	22
25411214R	1/2 x 1/4	10	500	4021343046834	16	22
25411238R	1/2 x 3/8	10	500	4021343046872	16	22
25413414R	3/4 x 1/4	10	300	4021343047190	18	27
25413438R	3/4 x 3/8	10	300	4021343047213	18	27
25413412R	3/4 x 1/2	10	300	4021343047176	18	27
2541138R	1 x 3/8	10	200	4021343046919	21	34
2541112R	1 x 1/2	10	200	4021343046674	21	34
2541134R	1 x 3/4	10	200	4021343046896	21	34
254111412R	1 1/4 x 1/2		140	4021343046797	22	42
254111434R	1 1/4 x 3/4		140	4021343046810	22	42
25411141R	1 1/4 x 1		140	4021343046773	22	42
254111212R	1 1/2 x 1/2		100	4021343046735	22	50
254111234R	1 1/2 x 3/4		100	4021343046759	22	50
25411121R	1 1/2 x 1		100	4021343046698	22	50
2541112114R	1 1/2 x 1 1/4		100	4021343046711	22	50
2541212R	2 x 1/2		55	4021343047015	25	60
2541234R	2 x 3/4		55	4021343047077	25	60
254121R	2 x 1		55	4021343046957	25	60
25412114R	2 x 1 1/4		55	4021343046995	25	60
25412112R	2 x 1 1/2		55	4021343046971	25	60
2541212112R*	2 1/2 x 1 1/2		55	4021343047039	28	76
25413114R*	3 x 1 1/4		40	4021343047114	32	90
25413112R*	3 x 1 1/2		40	4021343047091	32	90
verchromt						
25411418C	1/4 x 1/8	10	1000	4021343046926	13	14
25413818C	3/8 x 1/8	10	800	4021343047244	14	17
25413814C	3/8 x 1/4	10	700	4021343047220	14	17
25411218C	1/2 x 1/8	10	500	4021343046841	16	22
25411214C	1/2 x 1/4	10	600	4021343046827	16	22
25411238C	1/2 x 3/8	10	500	4021343046865	16	22
25413438C*	3/4 x 3/8	10	400	4021343047206	18	27
25413412C	3/4 x 1/2	10	300	4021343047169	18	27
2541112C	1 x 1/2	10	200	4021343046667	21	34
2541134C	1 x 3/4	10	200	4021343046889	21	34
254111412C	1 1/4 x 1/2		165	4021343046780	22	42
254111434C	1 1/4 x 3/4		165	4021343046803	22	42
25411141C	1 1/4 x 1		165	4021343046766	22	42
254111212C	1 1/2 x 1/2		100	4021343046728	22	50
254111234C*	1 1/2 x 3/4		100	4021343046742	22	50
25411121C	1 1/2 x 1		100	4021343046681	22	50
2541112114C	1 1/2 x 1 1/4		100	4021343046704	22	50
254121C	2 x 1		60	4021343046940	25	60
25412114C	2 x 1 1/4		55	4021343046988	25	60

* nur noch aus Lagervorrat lieferbar.

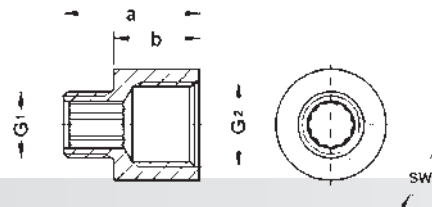

Katalog-Nr. und -bezeichnung

542 – Reduzierverlängerung, mit Innen- und Außengewinde, verchromt und roh

Artikel-Nr.	Abmessung G1 x G2	Beutel	Karton	EAN-Code-Nr.	a	b	SW
roh							
25421814R	1/8a x 1/4i	10	700	4021343047350	22	14	6
25421438R	1/4a x 3/8i	10	400	4021343047336	27	17	8
25423812R	3/8a x 1/2i	10	350	4021343047411	27	10	10
25421238R	1/2a x 3/8i	10	300	4021343047312	29	19	-
25421234R	1/2a x 3/4i	10	200	4021343047299	29	10	12
2542121R	1/2a x 1i	10	120	4021343137181	32	22	12
25423412R	3/4a x 1/2i	10	200	4021343047398	28	18	27
2542341R	3/4a x 1i	10	120	4021343047374	34	12	-
25421114R	1a x 11/4i		45	4021343047275	22	14	6
verchromt							
25421438C	1/4a x 3/8i	10	400	4021343047329	27	17	8
25423812C	3/8a x 1/2i	10	350	4021343047404	27	10	10
25421238C	1/2a x 3/8i	10	300	4021343047305	29	19	-
25421234C	1/2a x 3/4i	10	200	4021343047282	29	10	12
2542121C	1/2a x 1i	10	120	4021343172915	32	22	12
25423412C	3/4a x 1/2i	10	200	4021343047381	28	18	27
2542341C	3/4a x 1i	10	120	4021343047367	34	12	-

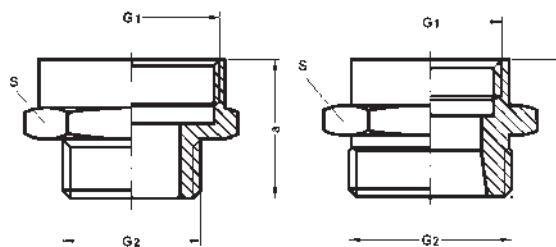

Katalog-Nr. und -bezeichnung

543 – Reduziernippel, Innen- und Außengewinde, roh

Artikel-Nr.	Abmessung G1 x G2	Beutel	Karton	EAN-Code-Nr.	a	s
25433812R*	3/8i x 1/2a	10	400	4021343172946	22	21
25431234R*	1/2i x 3/4a	10	180	4021343172960	24	27
25433412R*	3/4i x 1/2a	10	250	4021343181030	24	29
2543341R*	3/4i x 1a	10	120	4021343172977	26	33
2543134R*	1i x 3/4a	10	150	4021343172984	26	36
25431141R*	11/4i x 1a		80	4021343173004	29	42

* nur noch aus Lagervorrat lieferbar.

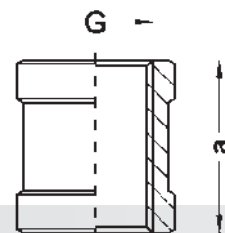

Katalog-Nr. und -bezeichnung

551 – Muffe, beidseitig mit Innengewinde, verchromt und roh

Artikel-Nr.	Abmessung G	Beutel	Karton	EAN-Code-Nr.	a
roh					
255118R	1/8	10	700	4021343047534	18
255114R	1/4	10	600	4021343047510	20
255138R	3/8	10	400	4021343047633	20
255112R	1/2	10	250	4021343047497	27
255134R	3/4	10	150	4021343047619	30
25511R	1	10	80	4021343047435	35
2551114R	1 1/4		50	4021343047473	39
2551112R	1 1/2		45	4021343047459	40
25512R	2		25	4021343047558	45
2551212R*	2 1/2		15	4021343047572	68
verchromt					
255118C	1/8	10	700	4021343047527	18
255114C	1/4	10	600	4021343047503	20
255138C	3/8	10	400	4021343047626	20
255112C	1/2	10	250	4021343047480	27
255134C	3/4	10	150	4021343047602	30
25511C	1	10	80	4021343047428	35
2551114C	1 1/4		50	4021343047466	39
2551112C	1 1/2		45	4021343047442	40
25512C	2		25	4021343047541	45

* nur noch aus Lagervorrat lieferbar.

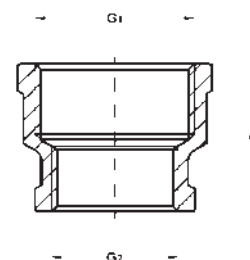

Katalog-Nr. und -bezeichnung

552 – Muffe, reduziert, beidseitig mit Innengewinde, verchromt und roh

Artikel-Nr.	Abmessung G1 x G2	Beutel	Karton	EAN-Code-Nr.	a
roh					
25523814R	3/8 x 1/4	10	350	4021343047855	27
25521238R	1/2 x 3/8	10	250	4021343047770	31
25523412R	3/4 x 1/2	10	200	4021343047831	32
2552112R	1 x 1/2	10	150	4021343047657	35
2552134R	1 x 3/4	10	100	4021343047794	36
255211412R	1 1/4 x 1/2		45	4021343047732	40
255211434R	1 1/4 x 3/4		45	4021343047756	41
25521141R	1 1/4 x 1		45	4021343047718	45
25521121R	1 1/2 x 1		36	4021343047671	44
2552112114R	1 1/2 x 1 1/4		36	4021343047695	47
25522112R	2 x 1 1/2		18	4021343047817	50
verchromt					
25523814C	3/8 x 1/4	10	350	4021343047848	27

Katalog-Nr. und -bezeichnung

552 – Muffe, reduziert, beidseitig mit Innengewinde, verchromt und roh (Fortsetzung)

Artikel-Nr.	Abmessung G1 x G2	Beutel	Karton	EAN-Code-Nr.	a
25521238C*	1/2 x 3/8	10	250	4021343047763	31
25523412C	3/4 x 1/2	10	200	4021343047824	32
2552112C	1 x 1/2	10	150	4021343047640	35
2552134C	1 x 3/4	10	100	4021343047787	36
255211434C	1 1/4 x 3/4		45	4021343047749	41
25521141C	1 1/4 x 1		45	4021343047701	45
25521121C	1 1/2 x 1		36	4021343047664	44
2552112114C	1 1/2 x 1 1/4		36	4021343047688	47
25522112C	2 x 1 1/2		18	4021343047800	50

* nur noch aus Lagervorrat lieferbar.

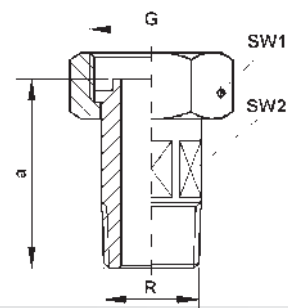

Katalog-Nr. und -bezeichnung

604 – Wasserzählerverschraubung für Eisenrohr, mit Plombier Vorrichtung, mit Außengewinde, verchromt und roh

Artikel-Nr.	Abmessung R x G	Beutel	Karton	EAN-Code-Nr.	a	z	SW1	SW2
roh								
26041234R	1/2 x 3/4	10	140	4021343047978	46	38	30	19
2604121R	1/2 x 1	10	100	4021343048012	48	38	37	24
2604341R	3/4 x 1	10	80	4021343047992	59	47	37	25
26041114R	1 x 1 1/4	10	50	4021343047954	70	57	46	32
verchromt								
26041234C	1/2 x 3/4	10	140	4021343047961	46	48	30	19
2604341C	3/4 x 1	10	80	4021343047985	59	47	37	25

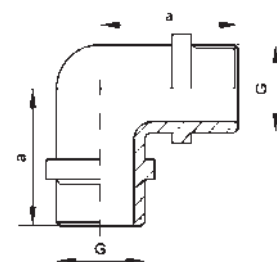

Katalog-Nr. und -bezeichnung

611 – Winkel 90°, beidseitig mit Außengewinde, verchromt und roh

Artikel-Nr.	Abmessung G	Beutel	Karton	EAN-Code-Nr.	a
roh					
261138R	3/8	10	250	4021343048357	30
261112R	1/2	10	120	4021343048319	34
261134R	3/4	10	80	4021343048333	40
26111R	1	10	40	4021343048296	45
verchromt					
261138C	3/8	10	250	4021343048340	30
261112C	1/2	10	120	4021343048302	34
261134C	3/4	10	80	4021343048326	40
26111C	1	10	40	4021343048289	45

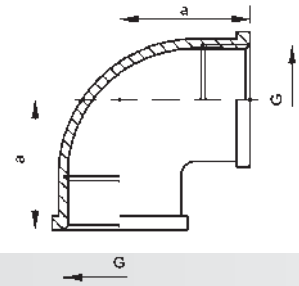

Katalog-Nr. und -bezeichnung
612 – Winkel 90°, beidseitig mit Innengewinde, verchromt und roh

Artikel-Nr.	Abmessung G	Beutel	Karton	EAN-Code-Nr.	a
roh					
261218R	1/8	10	600	4021343048470	14
261214R	1/4	10	400	4021343048456	18
261238R	3/8	10	200	4021343048555	22
261212R	1/2	10	140	4021343048432	25
261234R	3/4	10	80	4021343048531	30
26121R	1	10	40	4021343048371	35
2612114R	1 1/4	25	25	4021343048418	47
2612112R	1 1/2	15	15	4021343048395	50
26122R	2	10	10	4021343048494	58
verchromt					
261218C	1/8	10	600	4021343048463	14
261214C	1/4	10	400	4021343048449	18
261238C	3/8	10	200	4021343048548	22
261212C	1/2	10	140	4021343048425	25
261234C	3/4	10	80	4021343048524	30
26121C	1	10	40	4021343048364	35
2612114C	1 1/4	25	25	4021343048401	47
2612112C	1 1/2	15	15	4021343048388	50

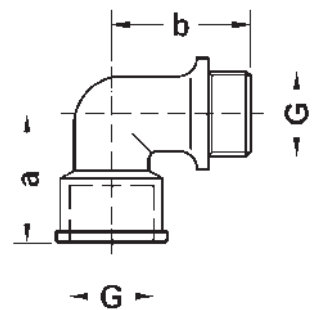

Katalog-Nr. und -bezeichnung
613 – Winkel 90°, mit Innen- und Außengewinde, verchromt und roh

Artikel-Nr.	Abmessung G	Beutel	Karton	EAN-Code-Nr.	a	b
roh						
261314R	1/4	10	300	4021343048692	26	26
261338R	3/8	10	150	4021343048777	29	32
261312R	1/2	10	140	4021343048678	32	35
261334R	3/4	10	60	4021343048753	39	42
26131R	1	10	40	4021343048616	46	46
2613114R	1 1/4	25	25	4021343048654	55	55
2613112R	1 1/2	20	20	4021343048630	60	64
26132R	2	10	10	4021343048715	70	77
verchromt						
261314C	1/4	10	300	4021343048685	26	26
261338C	3/8	10	150	4021343048760	29	32
261312C	1/2	10	140	4021343048661	32	35
261334C	3/4	10	60	4021343048746	39	42
26131C	1	10	40	4021343048609	46	46
2613114C	1 1/4	25	25	4021343048647	55	55
2613112C	1 1/2	20	20	4021343048623	60	64

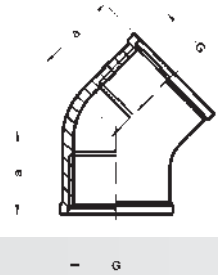

Katalog-Nr. und -bezeichnung

614 – Winkel 45°, beidseitig mit Innengewinde, verchromt und roh

Artikel-Nr.	Abmessung G	Beutel	Karton	EAN-Code-Nr.	a
roh					
261438R	3/8	10	300	4021343048852	20
261412R	1/2	10	180	4021343048814	25
261434R	3/4	10	100	4021343048838	30
26141R	1	10	50	4021343048791	29
verchromt					
261438C	3/8	10	300	4021343048845	20
261412C	1/2	10	180	4021343048807	25
261434C	3/4	10	100	4021343048821	30
26141C	1	10	50	4021343048784	29

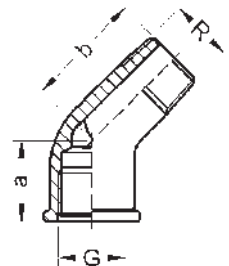

Katalog-Nr. und -bezeichnung

615 – Winkel 45°, mit Innen- und Außengewinde, verchromt und roh

Artikel-Nr.	Abmessung R x G	Beutel	Karton	EAN-Code-Nr.	a	b
roh						
261538R	3/8	10	250	4021343048937	20	-
261512R	1/2	10	170	4021343048890	23	34
261534R	3/4	10	100	4021343048913	25	36
26151R	1	10	50	4021343048876	28	41
verchromt						
261538C	3/8	10	250	4021343048920	20	-
261512C	1/2	10	170	4021343048883	23	34
261534C	3/4	10	100	4021343048906	25	36
26151C	1	10	50	4021343048869	28	41

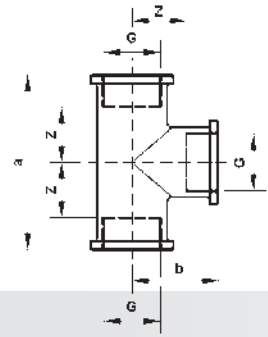

Katalog-Nr. und -bezeichnung
622 – T-Stück, allseitig mit Innengewinde, verchromt und roh

Artikel-Nr.	Abmessung G	Beutel	Karton	EAN-Code-Nr.	a	b	z
roh							
262218R	1/8	10	400	4021343049057	28	14	6
262214R	1/4	10	300	4021343049033	35	18	8
262238R	3/8	10	150	4021343049132	43	22	11
262212R	1/2	10	100	4021343049019	50	25	12
262234R	3/4	10	60	4021343049118	60	30	15
26221R	1	10	30	4021343048951	67	34	18
2622114R	1 1/4	20	20	4021343048999	90	45	26
2622112R	1 1/2	12	12	4021343048975	93	47	28
26222R	2	10	10	4021343049071	102	51	32
verchromt							
262218C*	1/8	10	400	4021343049040	28	14	6
262214C	1/4	10	300	4021343049026	35	18	8
262238C	3/8	10	150	4021343049125	43	22	11
262212C	1/2	10	100	4021343049002	50	25	12
262234C	3/4	10	60	4021343049101	60	30	15
26221C	1	10	30	4021343048944	67	34	18
2622114C	1 1/4	20	20	4021343048982	90	45	26
2622112C	1 1/2	12	12	4021343048968	93	47	28

* nur noch aus Lagervorrat lieferbar.

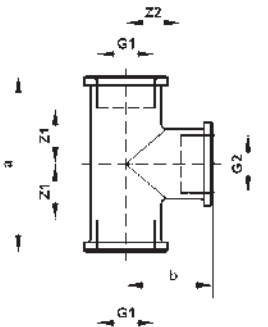

Katalog-Nr. und -bezeichnung
626 – T-Stück, reduziert, allseitig mit Innengewinde, verchromt und roh

Artikel-Nr.	Abmessung G1 x G2 x G1	Beutel	Karton	EAN-Code-Nr.	a	b	z1	z2
roh								
26261418R*	1/4 x 1/8	10	300	4021343049248	18	18	8	10
26261238R	1/2 x 3/8	10	100	4021343049200	51	26	13	16
26263412R	3/4 x 1/2	10	60	4021343049262	52	29	11	16
2626112R	1 x 1/2	10	40	4021343049163	67	34	17	19
2626134R	1 x 3/4	10	30	4021343049224	67	34	18	19
262611412R	1 1/4 x 1/2	5	25	4021343049187	90	40	26	23
verchromt								
26261238C*	1/2 x 3/8	10	100	4021343049194	51	26	13	16
26263412C	3/4 x 1/2	10	60	4021343049255	52	29	11	16
2626112C	1 x 1/2	10	40	4021343049156	67	34	17	19
2626134C	1 x 3/4	10	30	4021343049217	67	34	18	19

* nur noch aus Lagervorrat lieferbar.

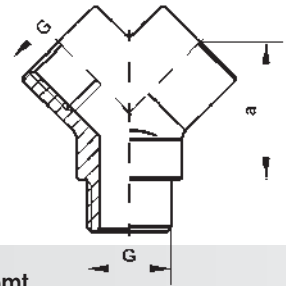

Katalog-Nr. und -bezeichnung

641 – Doppelanschluss-Stück (Gabel-Stück), mit 1 Außengewinde und 2 Innengewinden, verchromt

Artikel-Nr.	Abmessung G	Karton	EAN-Code-Nr.	a
264112C	1/2	50	4021343049279	34

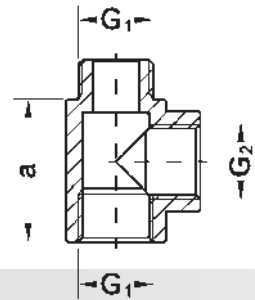

Katalog-Nr. und -bezeichnung

642 – Doppelanschluss-Stück (T-Stück), mit 1 Außengewinde und 2 Innengewinden, verchromt

Artikel-Nr.	Abmessung G1 x G2 x G1	Karton	EAN-Code-Nr.	a
26421212C	1/2 x 1/2	100	4021343049286	40
26423412C	3/4 x 1/2	80	4021343049293	40

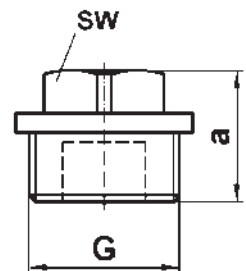

Katalog-Nr. und -bezeichnung

751 – Stopfen, mit Außengewinde, verchromt und roh

Artikel-Nr.	Abmessung G	Beutel	Karton	EAN-Code-Nr.	a	SW
roh						
275118R	1/8	10	2000	4021343050107	14	8
275114R	1/4	10	800	4021343050084	14	10
275138R	3/8	10	800	4021343050206	15	11
275112R	1/2	10	600	4021343050060	17	12
275134R	3/4	10	300	4021343050176	18	14
27511R	1	10	220	4021343050008	18	17
2751114R	1 1/4		140	4021343050046	20	19
2751112R	1 1/2		70	4021343050022	24	22
27512R	2		55	4021343050121	27	25

Katalog-Nr. und -bezeichnung

751 – Stopfen, mit Außengewinde, verchromt und roh (Fortsetzung)

Artikel-Nr.	Abmessung G	Beutel	Karton	EAN-Code-Nr.	a	SW
verchromt						
275114C	1/4	10	800	4021343050077	14	10
275138C	3/8	10	800	4021343050190	15	11
275112C	1/2	10	600	4021343050053	17	12
275134C	3/4	10	300	4021343050169	18	14
27511C	1	10	220	4021343049996	18	17
2751114C	1 1/4		140	4021343050039	20	19
2751112C	1 1/2		70	4021343050015	24	22
27512C	2		55	4021343050114	27	25

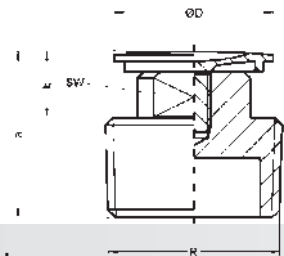

Katalog-Nr. und -bezeichnung

752 – Verschluss-Stopfen zum Abdecken nicht benutzter Leitungen, mit Außengewinde, verchromt

Artikel-Nr.	Abmessung G	Beutel	Karton	EAN-Code-Nr.	a	b	D	SW
275238C*	3/8	10	500	4021343050237	16	11	24	9
275212C	1/2	10	400	4021343050213	18	12	24	10
275234C	3/4	10	300	4021343050220	22	15	24	12

* nur noch aus Lagervorrat lieferbar.

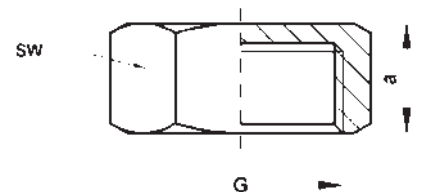
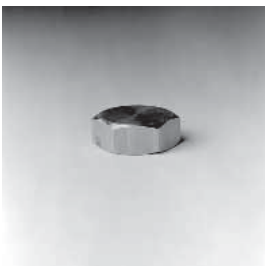

Katalog-Nr. und -bezeichnung

761 – Kappe, mit Innengewinde, verchromt und roh

Artikel-Nr.	Abmessung G	Beutel	Karton	EAN-Code-Nr.	a	SW
roh						
276118R	1/8	10	1500	4021343050350	10	13
276114R	1/4	10	1000	4021343050336	10	16
276138R	3/8	10	700	4021343050435	12	19
276112R	1/2	10	500	4021343050312	13	24
276134R	3/4	10	300	4021343050411	14	29
27611R	1	10	240	4021343050251	14	36
2761114R	1 1/4		150	4021343050299	14	45
2761112R	1 1/2		120	4021343050275	15	52
27612R	2		80	4021343050374	18	64
verchromt						
276114C	1/4	10	1000	4021343050329	10	16
276138C	3/8	10	700	4021343050428	12	19
276112C	1/2	10	500	4021343050305	13	24

Katalog-Nr. und -bezeichnung

761 – Kappe, mit Innengewinde, verchromt und roh (Fortsetzung)

Artikel-Nr.	Abmessung G	Beutel	Karton	EAN-Code-Nr.	a	SW
276134C	3/4	10	300	4021343050404	14	29
276111C	1	10	240	4021343050244	14	36
2761114C	1 1/4		150	4021343050282	14	45
2761112C	1 1/2		120	4021343050268	15	52
27612C*	2		80	4021343050367	18	64

* nur noch aus Lagervorrat lieferbar.

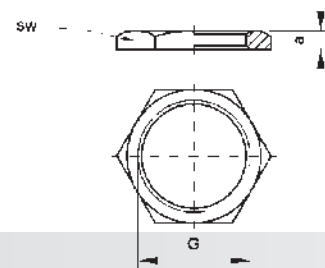

Katalog-Nr. und -bezeichnung

911 – Gegenmutter aus Messing, verchromt und roh

Artikel-Nr.	Abmessung G	Beutel	Karton	EAN-Code-Nr.	a	SW
roh						
291114R	1/4	10	1000	4021343051302	5	22
291138R	3/8	10	1000	4021343051401	5	22
291112R	1/2	10	800	4021343051289	5	27
291134R	3/4	10	600	4021343051371	6	34
291111R	1	10	500	4021343051227	7	37
2911114R	1 1/4	10	300	4021343051265	7	50
2911112R	1 1/2	10	150	4021343051241	8	60
29112R	2	10	100	4021343051333	9	70
verchromt						
291114C	1/4	10	1000	4021343051296	5	22
291138C	3/8	10	1000	4021343051395	5	22
291112C	1/2	10	800	4021343051272	5	27
291134C	3/4	10	600	4021343051364	6	34
291111C	1	10	500	4021343051210	7	37
2911114C	1 1/4	10	300	4021343051258	7	50
2911112C	1 1/2	10	150	4021343051234	8	60
29112C	2	10	100	4021343051326	9	70

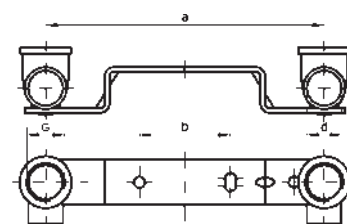

Katalog-Nr. und -bezeichnung

976 – Montageeinheit, mit Innengewinde und Lötanschluss, gekröpfte Ausführung

Artikel-Nr.	Abmessung d x G	Karton	EAN-Code-Nr.	a	b
29761512100R	15 x 1/2 x 100	40	4021343198281	100	30
29761512150R	15 x 1/2 x 150	30	4021343198298	153	50



Katalog-Nr. und -bezeichnung

976F – Montageeinheit, mit Innengewinde und Lötanschluss, flache Ausführung

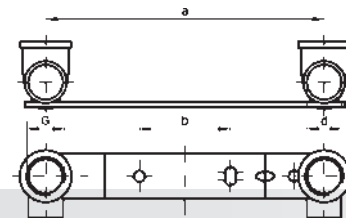

Artikel-Nr.	Abmessung d x G	Karton	EAN-Code-Nr.	a	b
2976F151280R	15 x 1/2 x 80	60	4021343198304	80	23
2976F1512100R	15 x 1/2 x 100	50	4021343198311	100	30
2976F1512150R	15 x 1/2 x 150	30	4021343198328	153	50



Katalog-Nr. und -bezeichnung

977 – Montageeinheit, beidseitig mit Innengewinde, gekröpfte Ausführung

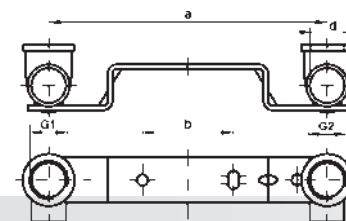

Artikel-Nr.	Abmessung G	Karton	EAN-Code-Nr.	a	b
29771212100R	1/2 x 1/2 x 100	30	4021343198335	100	30
29771212150R	1/2 x 1/2 x 150	25	4021343198342	153	50



Katalog-Nr. und -bezeichnung

977F – Montageeinheit, beidseitig mit Innengewinde, flache Ausführung

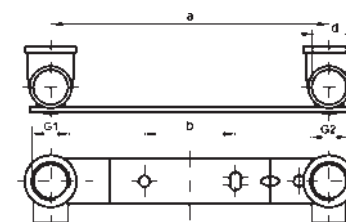

Artikel-Nr.	Abmessung G1 x G2	Karton	EAN-Code-Nr.	a	b
2977F121280R	1/2 x 1/2 x 80	50	4021343198359	80	23
2977F1212100R	1/2 x 1/2 x 100	50	4021343198366	100	30
2977F1212150R	1/2 x 1/2 x 150	25	4021343198373	153	50

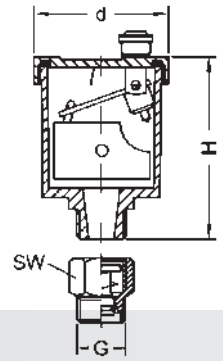

Katalog-Nr. und -bezeichnung

105 – Schnellentlüfter aus Pressmessing PN6, Arbeitstemperatur max. 110°C

Artikel-Nr.	Abmessung G	Karton	EAN-Code-Nr.	d	H	SW
310538	3/8	20	4021343052422	47	60	19
310512	1/2	20	4021343052415	47	60	23

VERBINDUNGSTECHNIK

Hahnverengerung
nach DIN 3523
aus Messing
(nach DIN 50 930-6)



RAL-G 643 2

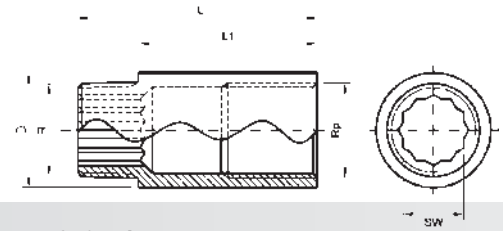
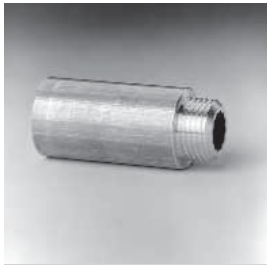

Katalog-Nr. und -bezeichnung

513 – Messing-Verlängerung mit Innenvielkant, aufgerauhtem Gewinde, spannungsfrei, roh

Artikel-Nr.	Abmessung G x L1	Beutel	Karton	EAN-Code-Nr.	L1	L	D	SW
25133810R	3/8 x 10	10	500	4021343043949	10	20	22	10
25133815R	3/8 x 15	10	400	4021343043987	15	25	22	10
25133820R	3/8 x 20	10	350	4021343044007	20	30	22	10
25133825R	3/8 x 25	10	300	4021343044021	25	35	22	10
25133830R	3/8 x 30	10	250	4021343044045	30	40	22	10
25133840R	3/8 x 40	10	200	4021343044069	40	50	22	10
25133850R	3/8 x 50	10	180	4021343044083	50	60	22	10
25133880R	3/8 x 80	10	120	4021343044120	80	90	22	10
251338100R	3/8 x 100	10	120	4021343043963	100	110	22	10
25131210R	1/2 x 10	10	300	4021343043345	10	21	27	12
25131215R	1/2 x 15	10	300	4021343043390	15	26	27	12
25131220R	1/2 x 20	10	200	4021343043413	20	31	27	12
25131225R	1/2 x 25	10	200	4021343043444	25	36	27	12
25131230R	1/2 x 30	10	180	4021343043468	30	41	27	12
25131240R	1/2 x 40	10	150	4021343043482	40	51	27	12
25131250R	1/2 x 50	10	120	4021343043536	50	61	27	12
25131265R	1/2 x 65	10	100	4021343043574	65	76	27	12
25131280R	1/2 x 80	10	90	4021343043598	80	91	27	12
251312100R	1/2 x 100	10	60	4021343043369	100	111	27	12
25133410R	3/4 x 10	10	300	4021343043734	10	22	32	17
25133415R	3/4 x 15	10	150	4021343043772	15	27	32	17
25133420R	3/4 x 20	10	140	4021343043802	20	32	32	17
25133425R	3/4 x 25	10	120	4021343043826	25	37	32	17
25133430R	3/4 x 30	10	100	4021343043840	30	42	32	17
25133440R	3/4 x 40	10	90	4021343043864	40	52	32	17
25133450R	3/4 x 50	10	80	4021343043888	50	62	32	17
25133465R	3/4 x 65	10	60	4021343043901	65	77	32	17
25133480R	3/4 x 80	10	50	4021343043925	80	92	32	17
251334100R	3/4 x 100	10	40	4021343043758	100	112	32	17
2513115R	1 x 15	10	120	4021343043291	15	27	39	22
2513120R	1 x 20	10	100	4021343043321	20	34	39	22
2513125R	1 x 25	10	70	4021343043512	25	39	39	22
2513130R	1 x 30	10	70	4021343043611	30	44	39	22
2513140R	1 x 40	10	70	4021343043642	40	54	39	22
2513150R	1 x 50	10	50	4021343043666	50	64	39	22
2513165R	1 x 65	5	45	4021343043697	65	79	39	22
2513180R	1 x 80	5	40	4021343043710	80	94	39	22
25131100R	1 x 100	5	30	4021343043260	100	114	39	22

Hahnverngerung, verchromt

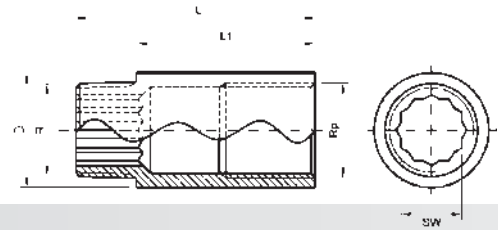

Katalog-Nr. und -bezeichnung

513 – Messing-Verlängerung mit Innenvielkant, aufgerauhtem Gewinde, spannungsfrei, verchromt

Artikel-Nr.	Abmessung G x L1	Beutel	Karton	EAN-Code-Nr.	L1	L	D	SW
25133810C	3/8 x 10	10	500	4021343043932	10	20	22	10
25133815C	3/8 x 15	10	400	4021343043970	15	25	22	10
25133820C	3/8 x 20	10	350	4021343043994	20	30	22	10
25133825C	3/8 x 25	10	300	4021343044014	25	35	22	10
25133830C	3/8 x 30	10	250	4021343044038	30	40	22	10
25133840C	3/8 x 40	10	200	4021343044052	40	50	22	10
25133850C	3/8 x 50	10	180	4021343044076	50	60	22	10
25133865C*	3/8 x 65	10	150	4021343044090	65	75	22	10
25133880C*	3/8 x 80	10	120	4021343044113	80	90	22	10
251338100C	3/8 x 100	10	120	4021343043956	100	110	22	10
25131210C	1/2 x 10	10	300	4021343043338	10	21	27	12
25131215C	1/2 x 15	10	300	4021343043376	15	26	27	12
25131220C	1/2 x 20	10	200	4021343043406	20	31	27	12
25131225C	1/2 x 25	10	200	4021343043420	25	36	27	12
25131230C	1/2 x 30	10	180	4021343043451	30	41	27	12
25131240C	1/2 x 40	10	150	4021343043475	40	51	27	12
25131250C	1/2 x 50	10	120	4021343043529	50	61	27	12
25131265C	1/2 x 65	10	100	4021343043567	65	76	27	12
25131280C	1/2 x 80	10	90	4021343043581	80	91	27	12
251312100C	1/2 x 100	10	60	4021343043352	100	111	27	12
25133410C	3/4 x 10	10	300	4021343043727	10	22	32	17
25133415C	3/4 x 15	10	150	4021343043765	15	27	32	17
25133420C	3/4 x 20	10	140	4021343043789	20	32	32	17
25133425C	3/4 x 25	10	120	4021343043819	25	37	32	17
25133430C	3/4 x 30	10	100	4021343043833	30	42	32	17
25133440C	3/4 x 40	10	90	4021343043857	40	52	32	17
25133450C	3/4 x 50	10	80	4021343043871	50	62	32	17
25133460C	3/4 x 60	10	70	4021343043207	60	72	32	17
25133465C	3/4 x 65	10	60	4021343043895	65	77	32	17
25133480C	3/4 x 80	10	50	4021343043918	80	92	32	17
251334100C	3/4 x 100	10	40	4021343043741	100	112	32	17
2513115C	1 x 15	10	120	4021343043284	15	27	39	22
2513120C	1 x 20	10	100	4021343043307	20	34	39	22
2513125C	1 x 25	10	70	4021343043499	25	39	39	22
2513130C	1 x 30	10	70	4021343043604	30	44	39	22
2513140C	1 x 40	10	70	4021343043628	40	54	39	22
2513150C	1 x 50	10	50	4021343043659	50	64	39	22
2513165C	1 x 65	5	45	4021343043673	65	79	39	22
2513180C	1 x 80	5	40	4021343043703	80	4	39	22
25131100C	1 x 100	5	30	4021343043523	100	114	39	22

* nur noch aus Lagervorrat lieferbar.



Katalog-Nr. und -bezeichnung

9900 – Abpresszapfen, PVC hart

Artikel-Nr.	Abmessung R	Karton	EAN-Code-Nr.
8990038	3/8	60	4021343093869
8990012	1/2	50	4021343093845
8990034	3/4	30	4021343093852



Katalog-Nr. und -bezeichnung

9901 – Abpresszapfen mit Messing, Außengewinde

Artikel-Nr.	Abmessung R	Karton	EAN-Code-Nr.
8990112	1/2	50	4021343166891