

200kW max.

BOILER OUTPUT

1kW = 3400 BTUs

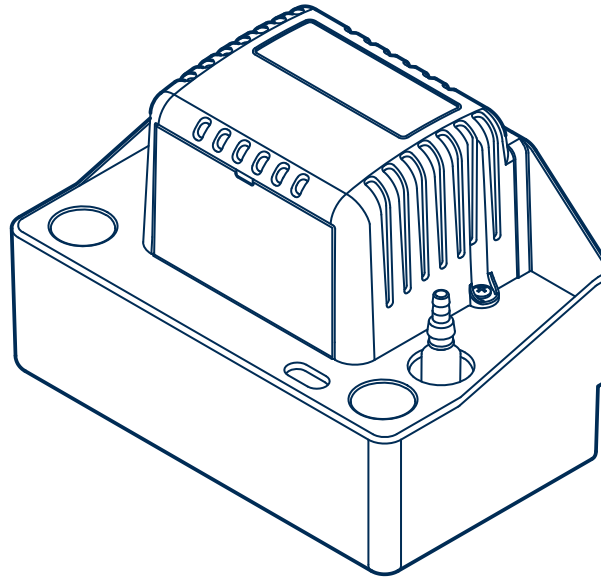
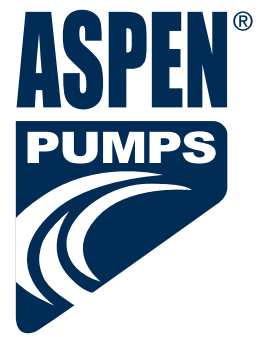

Hi-Capacity Boiler Pump

INSTRUCTIONS

In the box

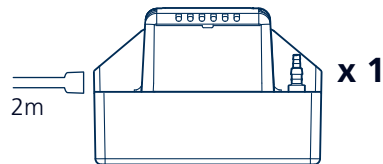

x 1

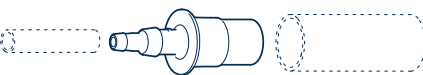

x 1

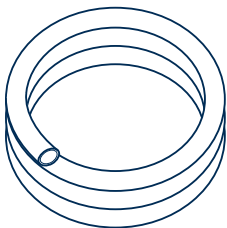

x 1

10mm I.D. x 6m

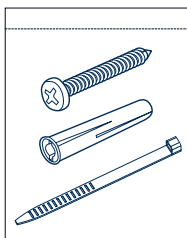

x 3

x 3

x 2

Safety

- If pump fails, the Safety Float switch will shut off boiler operation.
- Pump suitable for boiler with heat output 200kW condensate PH value +2.7.
-  **Do not handle pump in wet conditions or with wet hands.**
- To reduce the risk of electric shock, ensure electrical supply is permanently wired to earth.

Specification

- Inlet up to 27mm
- Tank capacity: 2L
- High level safety cut-out
- Outlet size: 6 & 10mm
- Maximum water temperature: 60°C

Installation

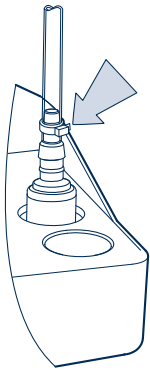
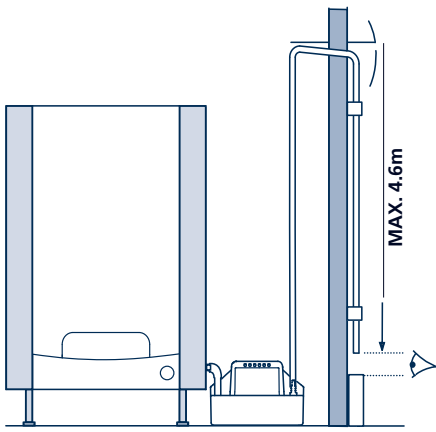

Position the pump alongside the boiler so that the water flows into the top inlet hole.

Connect the supplied 6m length of 10mm I.D. tubing to the pump outlet using hose clips supplied.

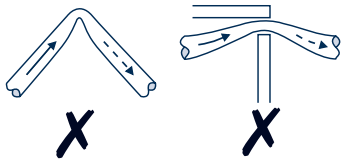

Ensure that there are no kinks or trapped parts.

- If it is not possible to create a downward slope, you must create an inverted U directly above the pump at the highest point.
- Where the tubing from the pump is connected directly to the soil stack or waste pipe, there must always be either a waste trap after the tubing connection or a 75mm U trap formed within the tubing.
- Where the tubing from the pump is connected to an external soil and vent stack extra care is necessary to ensure that the condensate pipe could not be blocked through the condensate freezing.

Power Supply

- 230V AC 16W
- 1PH 50/60 Hz
- 3A alarm wires, normally closed
- Double insulated

Electrical Connections

Live: Brown
Neutral: Blue
Safety switch: 2x Black Earth – Yellow/Green

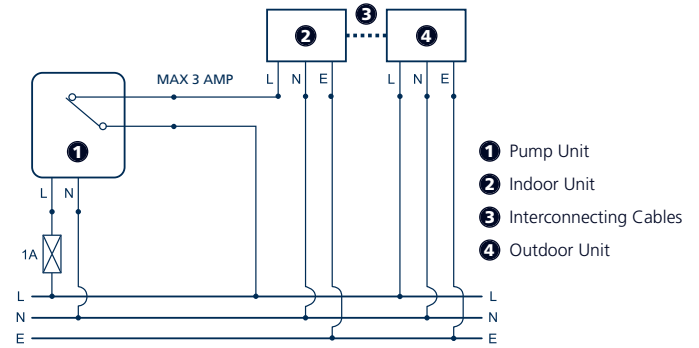

! The pre-wired safety switch **SHOULD ALWAYS** be utilised.

- If a fused plug is used, a 3 amp fuse is recommended.

Commissioning & Maintenance

- Before servicing the pump, make sure the electrical power is disconnected at the fuse box for both the pump and boiler.
- When commissioning the pump please check for debris in the pump tank. Remove any material that might block the drain line or drain into the boiler pump.
- Check the inlet and outlet piping ensuring that there are no restrictions in the tubing.
- Flush the pump through with anti-bacterial wash every 6 months to avoid sludge build-up in the pump housing.
 NB: The contractors should ensure that any chemicals used are compatible with the working of the pump.

IMPORTANT: The pre-wired switch must always be utilised.

- Pump should be filled with water until motor runs, check for leaks and proper discharge of water.

Contact Aspen Pumps for further help.

Performance

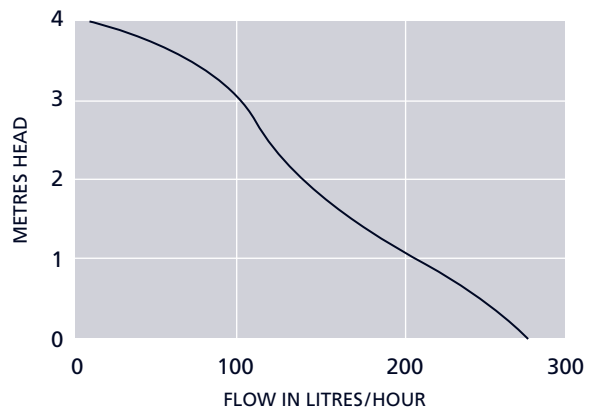

Whilst every care has been taken to ensure that the information included in this document was accurate at the time of printing, we reserve the right to change specifications at any time.

For further information please visit
www.aspenpumps.com
 or contact +44 (0)1323 848842

designed by engineers for engineers