

# FRICO

## Thermozone

### AD210C03

### AD210C05

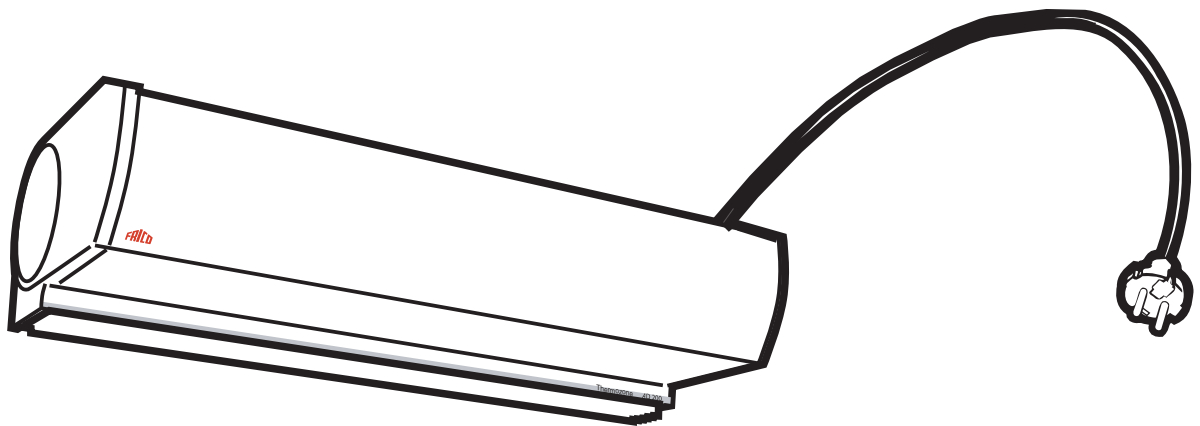

Тел.: (495) 669-37-15 (многоканальный)  
SIP: 0030047810  
e-mail: info@frico-tm.ru  
www.frico-tm.ru

# Thermozone AD210C03 / AD210C05

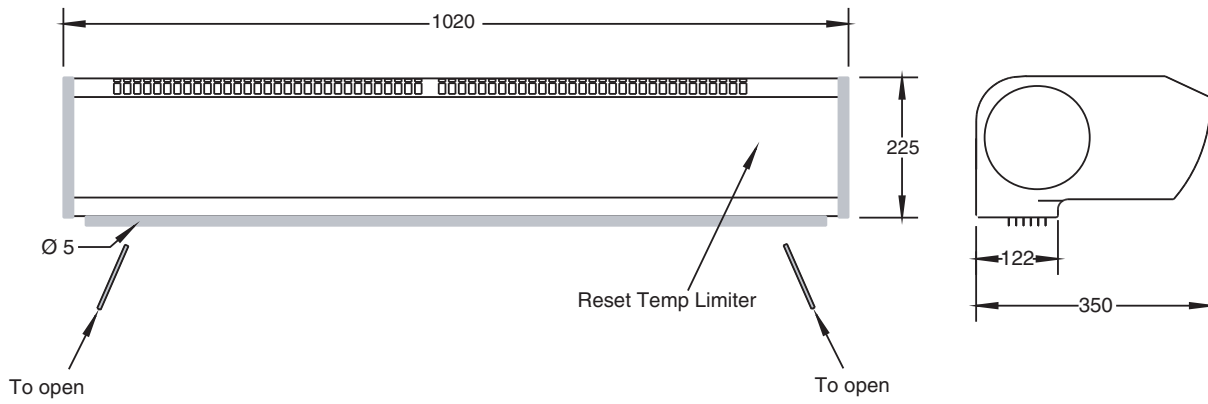

## Mounting alternatives

(A and B, standard brackets included in delivery, D and E, accessories)

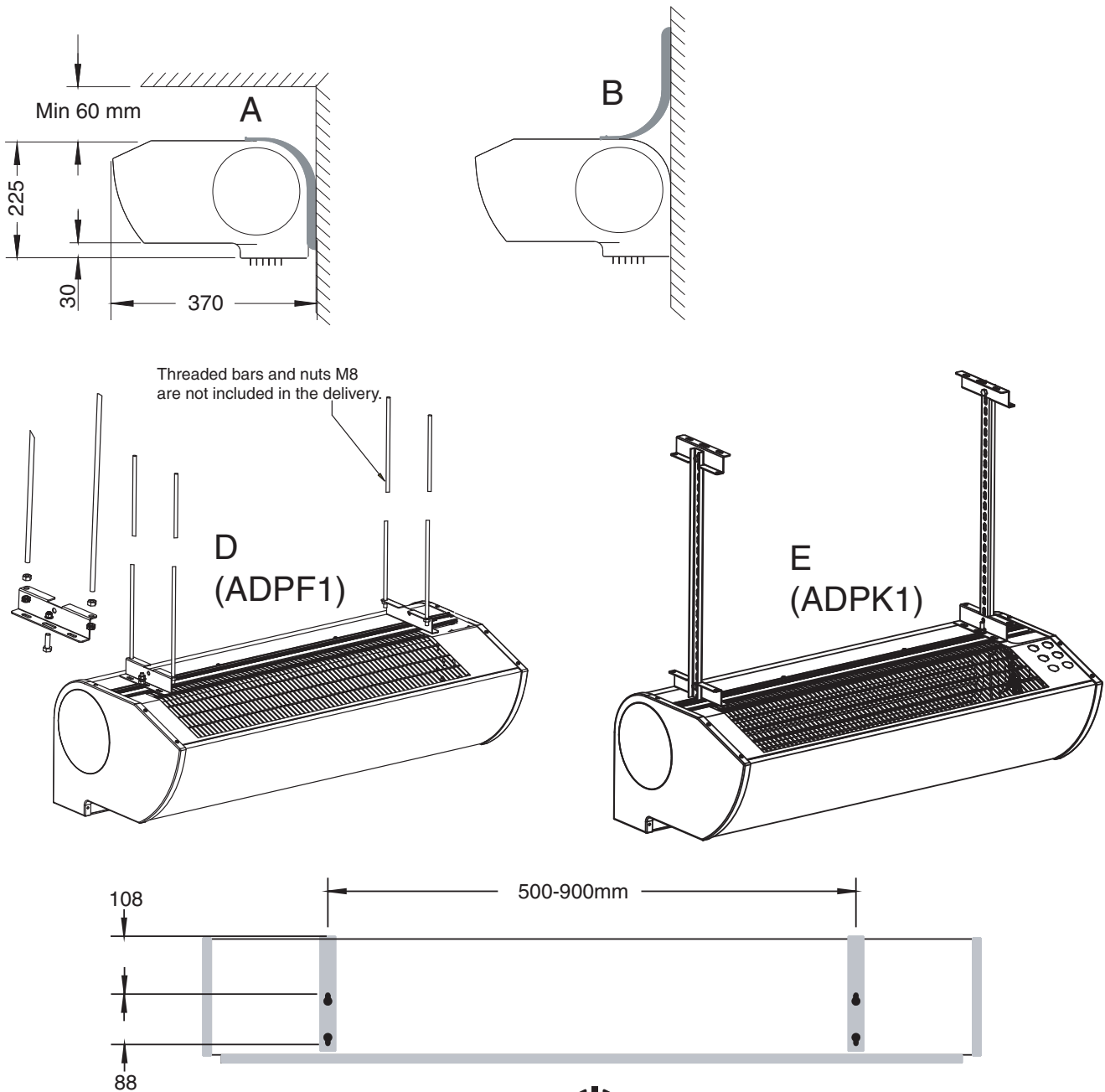

# Thermozone AD210C03 / AD210C05

## AD210C03

## AD210C05

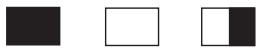
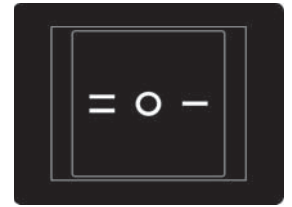
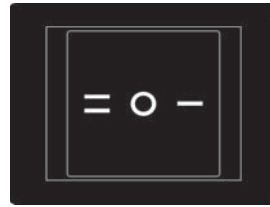
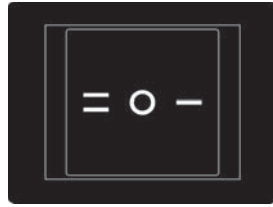

2 kW



900 m3/h



3 kW



900 m3/h



3 kW



1400 m3/h



4,5 kW



1400 m3/h



Thermostat  
5 - 35 °C



Thermostat  
5 - 35 °C



14 kg



(IP 21)



14 kg



(IP 21)

AD210C03

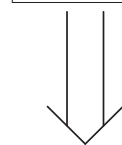
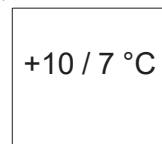

AD210C05

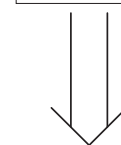
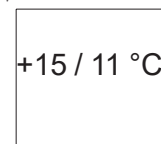

41 / 51 dB(A)

41 / 51 dB(A)

230 V~, 50 Hz, 13,5A

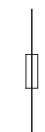
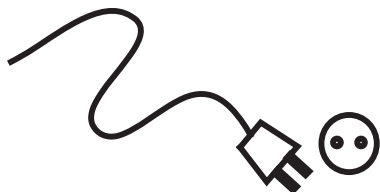

16 A

230 V~, 50 Hz, 20,1A



20/25A

При работе поверхность аппарата нагревается! Аппарат не должен располагаться вблизи легковоспламеняющихся материалов! Нельзя накрывать аппарат полностью или частично одеждой или чем-либо другим. В этом случае может возникнуть перегрев и создается опасность возгорания и пожара!