



www.esbe.se



**SERIES VRG130**



NO.1 IN HYDROMIC SYSTEM CONTROL



Series VRG131  
Series VRG132  
Series VRG133

CE  
Pressure Equipment Directive 97/23/EC

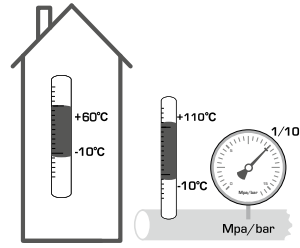

**1**

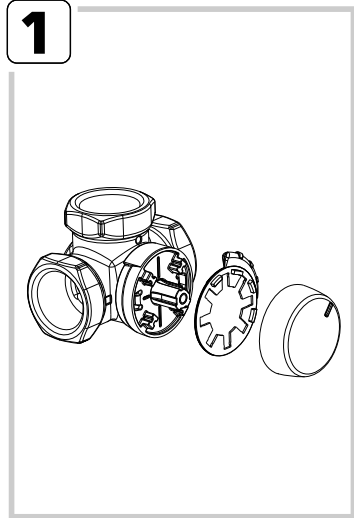

**i**

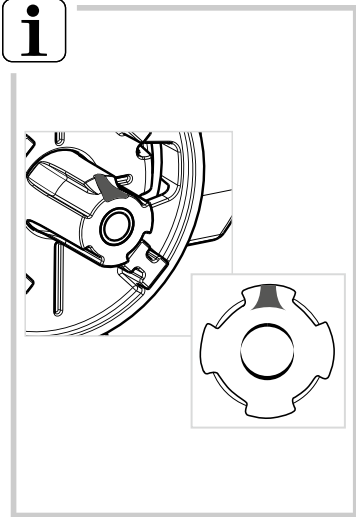

**2**

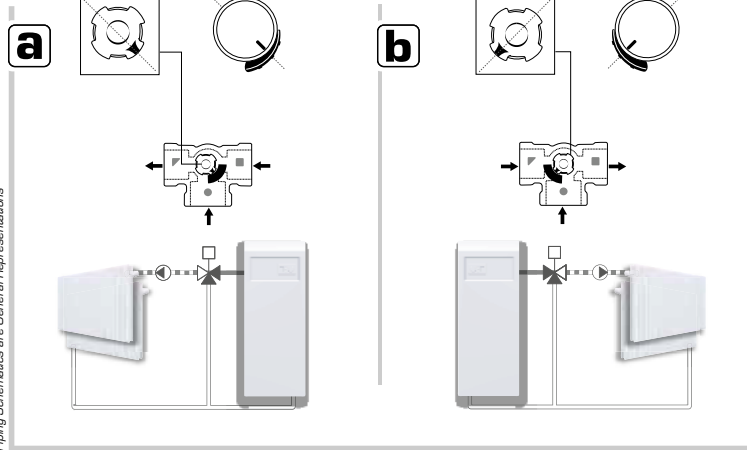

Piping Schematics are General Representations

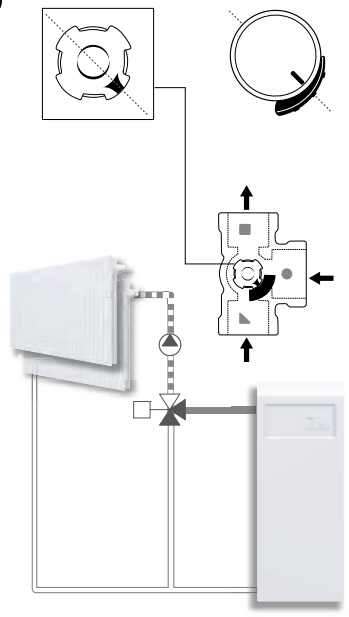
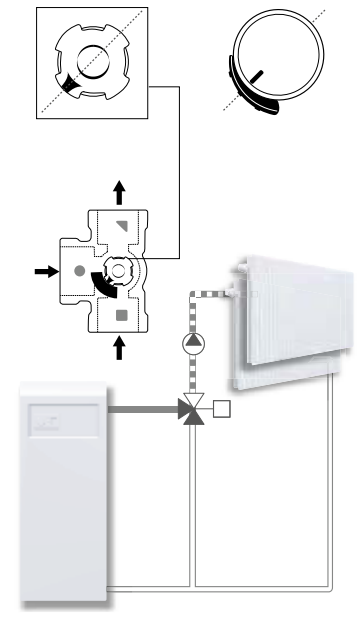
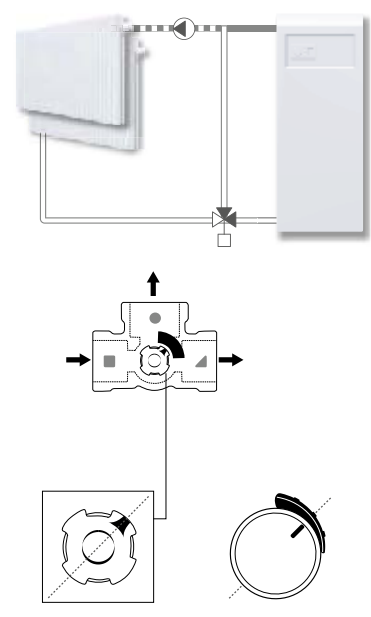
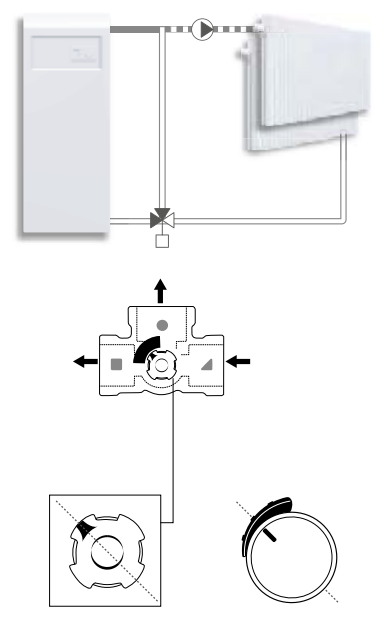
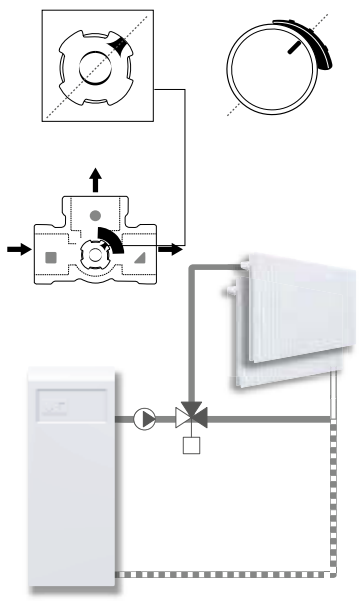
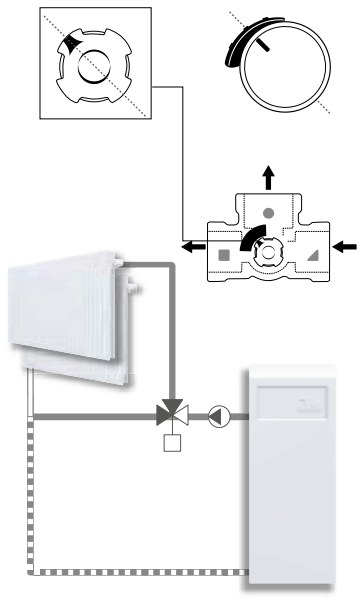
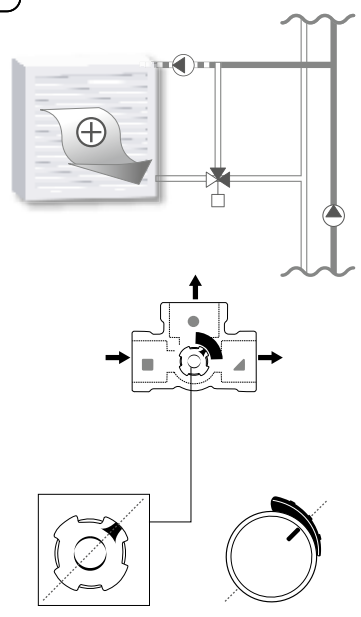
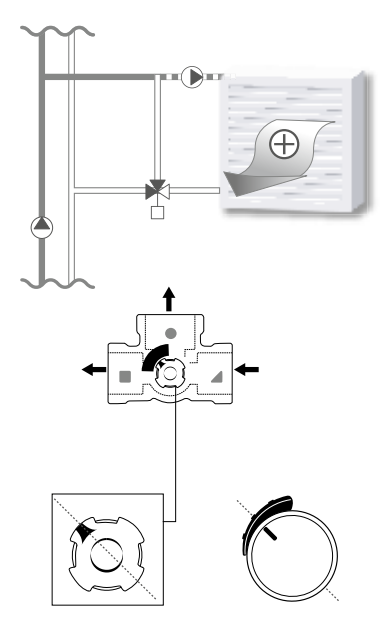
**3****a****b****4****a****b****5****a****b****6****a****b**

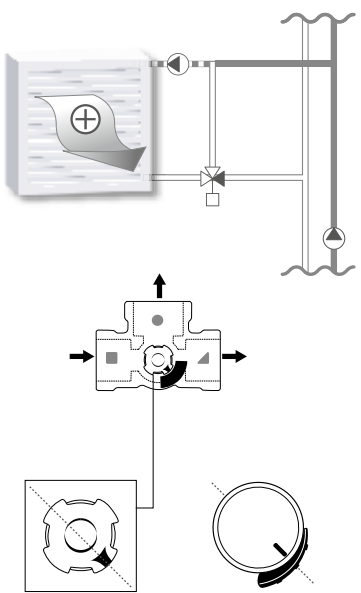
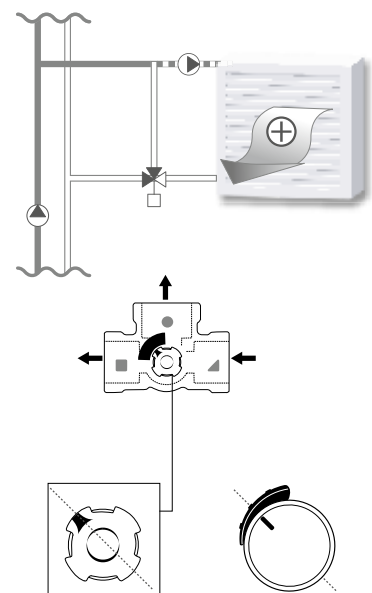
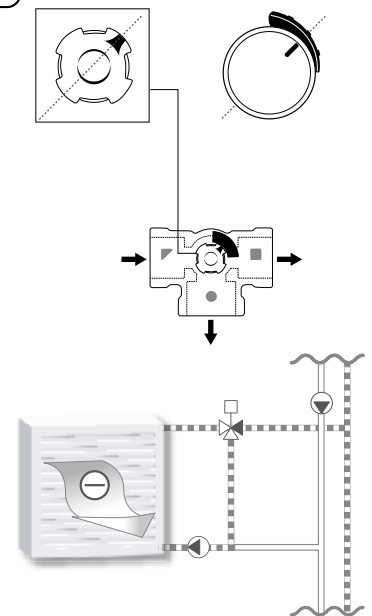
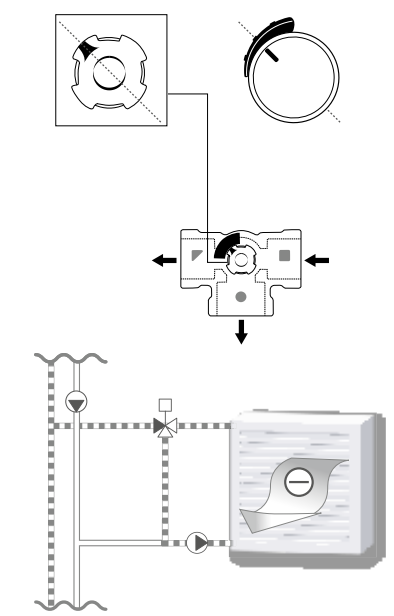
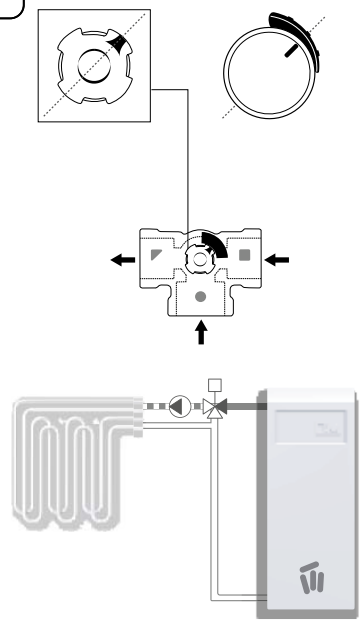
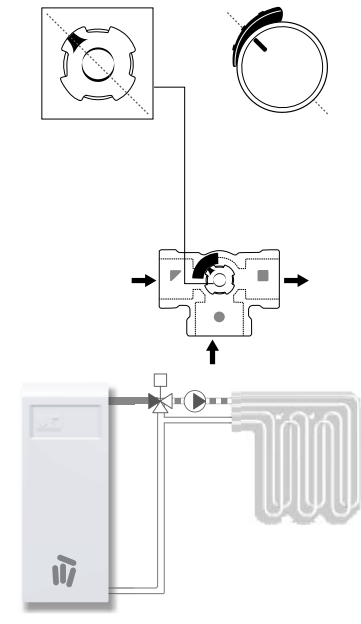
**7****a****b****8****a****b****9****a****b****i****SE**

"Denna produkt är anpassad till Branschregler och Säker Vattenskallation. Leverantören garanterar produktens funktion om branschreglerna och monteringsanvisningen följs."