

# **AIRSTAGE™** **V** **SERIES**

Variable Refrigerant Flow System  
*Multi Air Conditioning System for Buildings*



**Large Capacity Multi VRF System**  
**DC Inverter Control Compressor**  
**Long Piping System Design**  
**High Efficiency Refrigerant R410A**



# AIRSTAGE™

## V SERIES

High reliability multi air conditioning system for buildings which confirms the technological advances of the Fujitsu General range of air conditioners preferred in more than 90 countries around the world

### Features

## DC Inverter Control Compressor

The introduction of high efficiency DC inverter compressors and the latest in control technology provides more precise operation, improving system efficiency, resulting in energy saving and better economy.



## High Efficiency Refrigerant R410A

The environmental load has been reduced by using the zero ozone layer depleting potential, high efficiency refrigerant, R410A. This refrigerant provides increased energy efficiency, system performance and heat transfer, resulting in a reduction in pipe sizes compared to previous models. This also leads to cost savings during the installation phase of a project.

Actual pipe length  
**150m<sub>max.</sub>**

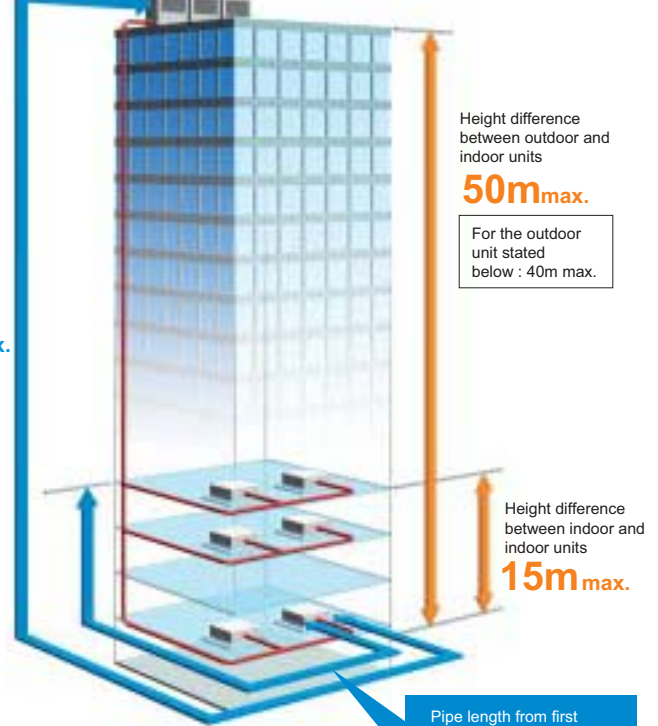

## Long Piping System Design

Maximum piping length 150m. Key design features allows 60m between the first separation tube and farthest indoor unit. This also allows use in large buildings and provides a high degree of design flexibility.

### System Line up

Outdoor units can be combined with varieties of capacities according to scale and use.

#### Model line up

Capacity	Model name	
	Master units	Slave units
22.4kW (8HP)	AJ*A72LATF	AJ*A72UATF
28.0kW (10HP)	AJ*A90LATF	AJ*A90UATF
40.0kW (14HP)	AJ*126LATF	AJ*126UATF

AJ\* : AJY (FUJITSU ), AJG (GENERAL)

#### Capacity range

HP	Capacity (kW)	Maximum connectable indoor unit <sup>*3</sup>	Indoor unit connectable capacity (kW)	
8	22.4	15	11.2-33.6	*1 *2 50-150%
10	28.0	16	14.0-42.0	
14	40.0		20.0-60.0	
16	44.8	30	22.4-67.2	*1 50-150%
18	50.4	32	25.2-75.6	
20	56.0		28.0-84.0	
22	62.4		31.2-93.6	
24	68.0		34.0-102	
26	72.8		36.4-109	
28	80.0		40.0-120	
30	84.0	48	42.0-126	
32	90.4		45.2-135	
34	96.0		48.0-144	
36	102		51.2-153	
38	108		54.0-162	
42	120		60.0-180	

\*1 Based on rated cooling capacity.

\*2 Indoor unit connectable capacity is 75 to 150% in case of including indoor unit model code 18 and under in the system.

\*3 Minimum connectable indoor unit number is 2. However ARXC90 can be used single connection.



# Large Capacity Multi VRF System

The ability to connect 3 outdoor units together in series up to a total capacity of 42HP (120kW) in each 2HP offers greater design freedom, reducing the number of outdoor units and piping installation space compared the conventional models.

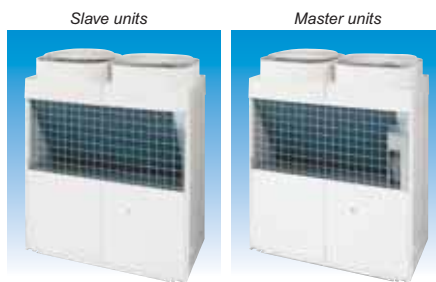

By combining 6 types (Master Unit and Slave Unit 8/10/14 HP) of 1 to 3 Outdoor Units, ranging from 8 HP (22.4 kW) to 42 HP (120 kW).

## Variation of capacity range

It can be corresponded to the wide variation of 8-42HP(22.4-120.0kW).

No. of outdoor unit	System total capacity (kW)						
	22.4 (8HP)	28.0 (10HP)	40.0 (14HP)	—	—	—	—
2	44.8 (16HP)	50.4 (18HP)	56.0 (20HP)	62.4 (22HP)	68.0 (24HP)	80.0 (28HP)	—
3	72.8 (26HP)	84.0 (30HP)	90.4 (32HP)	96.0 (34HP)	102 (36HP)	108 (38HP)	120 (42HP)

## Combination of outdoor units

HP	Capacity (kW)	Master	Slave1	Slave2
8	22.4	AJ*A72LATF	—	—
10	28.0	AJ*A90LATF	—	—
14	40.0	AJ*126LATF	—	—
16	44.8	AJ*A72LATF	AJ*A72UATF	—
18	50.4	AJ*A90LATF	AJ*A72UATF	—
20	56.0	AJ*A90LATF	AJ*A90UATF	—
22	62.4	AJ*126LATF	AJ*A72UATF	—
24	68.0	AJ*126LATF	AJ*A90UATF	—
28	80.0	AJ*126LATF	AJ*126UATF	—
26	72.8	AJ*A90LATF	AJ*A72UATF	AJ*A72UATF
30	84.0	AJ*A90LATF	AJ*A90UATF	AJ*A90UATF
32	90.4	AJ*126LATF	AJ*A90UATF	AJ*A72UATF
34	96.0	AJ*126LATF	AJ*A90UATF	AJ*A90UATF
36	102	AJ*126LATF	AJ*126UATF	AJ*A72UATF
38	108	AJ*126LATF	AJ*126UATF	AJ*A90UATF
42	120	AJ*126LATF	AJ*126UATF	AJ*126UATF

AJ\* : AJY (FUJITSU ), AJG (GENERAL)

## Contents

- **High reliability** ..... 4
  - Compressor rotation control
  - Optimum oil control
  - Emergency operation
  - Web monitoring tool
- **Improved comfort** ..... 5
  - Room temperature control
  - Inverter control
  - Liquid level balance control
  - Super quiet
- **Design freedom** ..... 6
  - Connectable large capacity
  - Low outdoor air temperature operation
  - Compact outdoor unit
  - Communication wire method
- **High efficiency operation** ..... 7
  - High COP
  - High efficiency refrigerant R410A
  - Sine-wave DC inverter
  - DC inverter control compressor
  - Effective use of the heat exchanger of other outdoor units
- **Service and maintainability** ..... 7
- **Indoor units line up** ..... 8-9
- **Control system** ..... 10-11

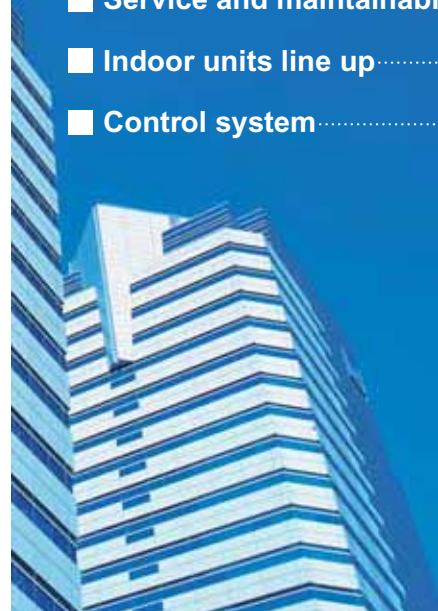

# High reliability provides a constant comfortable indoor environment

## Compressor rotation control

### Improvement of long life by reducing compressor wear

In addition to control which reduces the number of times the compressor is started and stopped, the load at starting is shared and equalized by rotation control. This rotation improves the durability and reliability of each compressor.

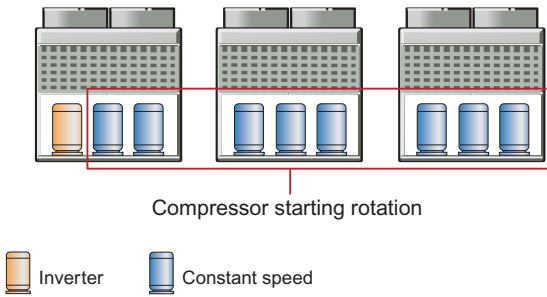

## Optimum oil control

### Stable operation of compressor by optimum oil control

- (1) High trapping efficiency, large capacity cyclone type oil separator
- (2) Oil balance control which maintains a uniform oil level
- (3) Oil recovery control by monitoring of refrigerant flow velocity

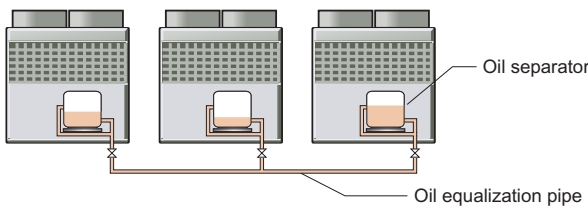

## Emergency operation

### Outdoor unit

#### Continuous operation is possible even in the unlikely event of compressor trouble occurring

There is no immediate system shutdown if trouble occurs in any compressor. The other compressors continue to operate on an emergency basis.

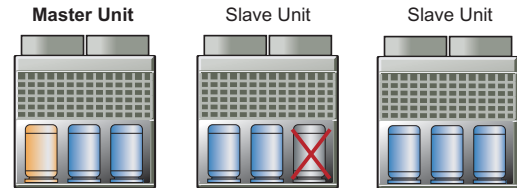

### Indoor unit

#### Continuous operation is possible even if trouble occurs at an indoor unit

Each indoor unit is controlled individually on the system network. This allows all indoor units continue to run unaffected even if trouble should occur at one indoor unit in the system.

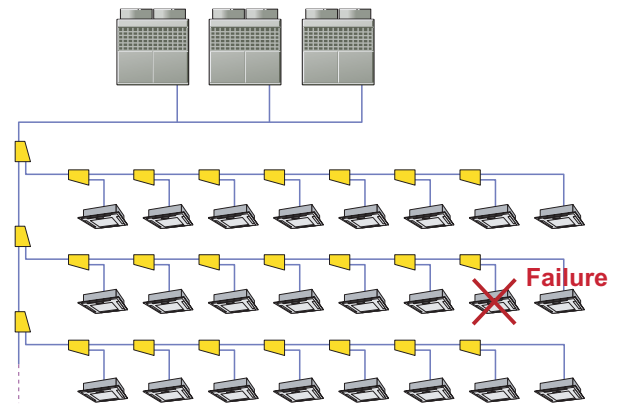

## Web monitoring tool

### UTR-YMSA

Software

#### Trouble free operation at all times by web monitoring tool

The operational status of the VRF system within the building can be monitored in real time over the Internet. Periodic system checks can be performed regularly with error notification E-mail can be automatically transmitted to remote users.

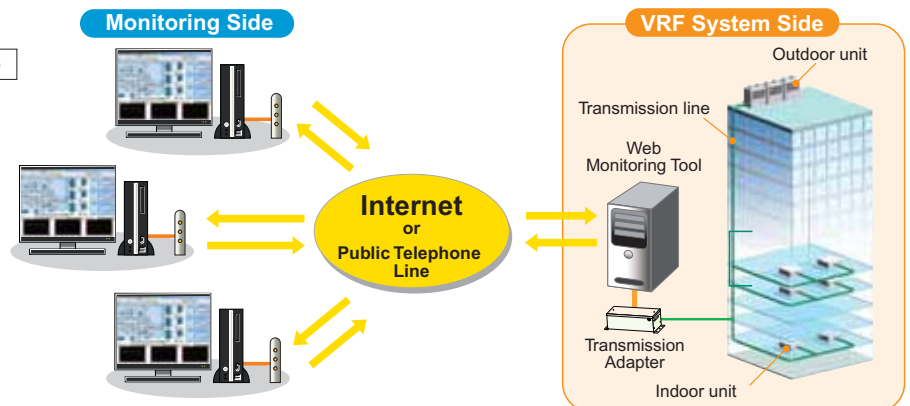

# Comfort enabled by high precision control technology



## Room temperature control

### Comfort at any time by high precision refrigerant flow control

High precision  $\pm 0.5^{\circ}\text{C}$  ensures comfortable temperature control of the room. This is achieved by smooth refrigerant flow, controlled by inverter and room feedback control by the indoor unit electronic expansion valve.

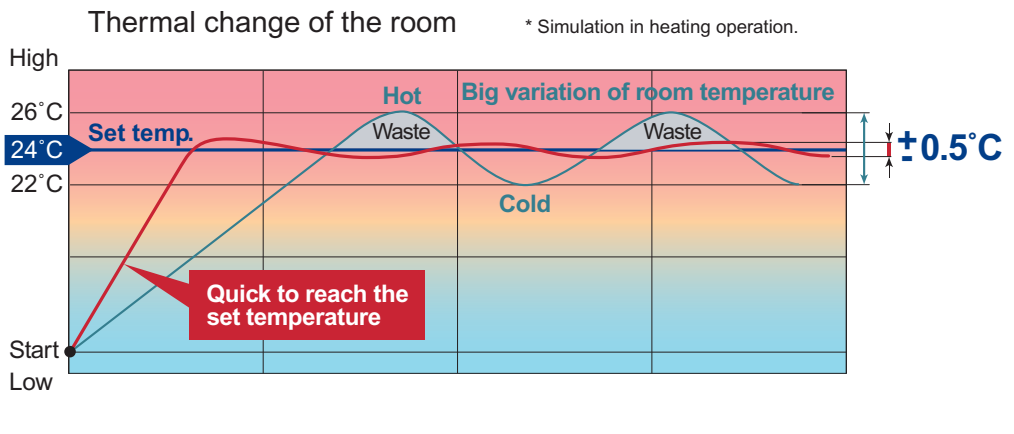

Comfortable due to Small variation of room temperature

## Inverter control

### Comfort and energy saving achieved by implementation of inverter control

Comfort and energy saving is achieved by the adoption of linear STEP control in conjunction with inverter and constant speed compressor combination, which allows more precise control of the necessary refrigerant circulation amount required according to the system load. This also allows for a comfortable environment by use of smooth capacity control.

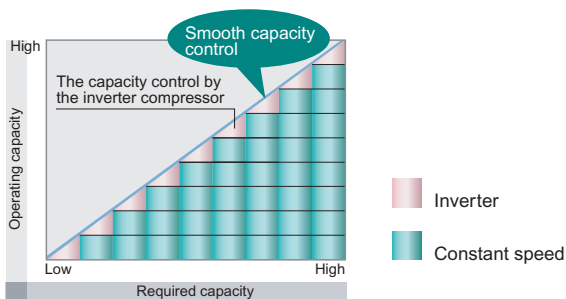

## Super Quiet

### Quiet operating sound outdoor unit achieved

Operating noise has been reduced still further through the application of a new dual casing bell mouth and large fan. The noise level can be reduced by 4-5dB (A) compared to normal operation by selecting silent operation.



## Liquid level balance control

### Stable capacity and reduction of refrigerant noise by optimum state refrigerant

Balancing of the refrigerant in the system is optimized by liquid level balance control and subcool circuit between the receiver tanks of each outdoor unit. Stable refrigerant supply allows long pipe runs and achieves stable operational system performance whilst reducing unpleasant refrigerant noise.

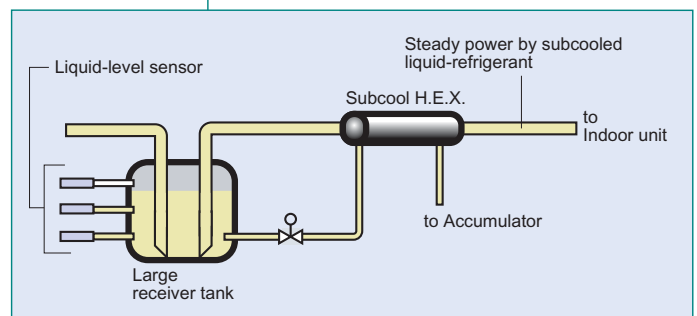
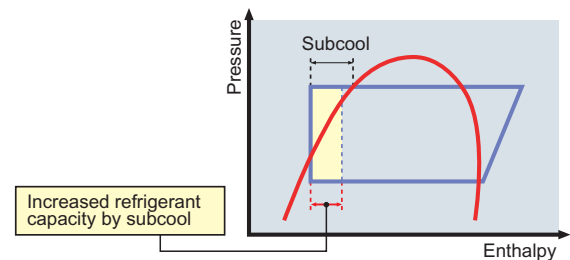

# Design features ensures that solutions are provided for all applications

## Connectable large capacity

Indoor units up to 150% of the capacity of the outdoor unit can be connected

The indoor unit connection ratio of this system can be from 50 to 150% of the outdoor unit capacity, thus achieving the industry's highest level of diversification with up to 48 indoor units (30 to 42HP) connectable on one refrigerant system.

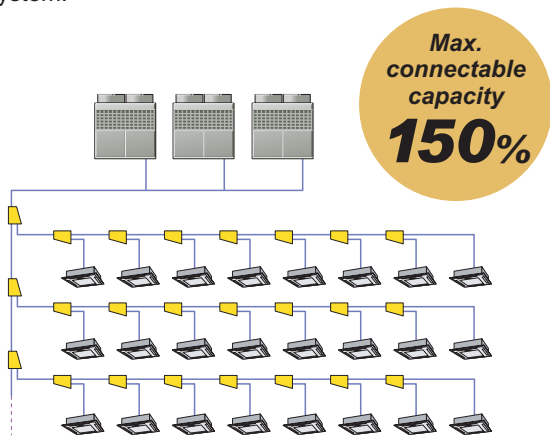

Note: When all indoor units are operating at maximum capacity, the individual indoor units operate at a slightly lower capacity.

## Compact outdoor unit

Installation space can be reduced freeing up valuable building space

Outdoor unit installation space can be reduced by up to approximately 33% by installing the V Series compared to a 28HP system with our conventional model. In addition, the number of pipelines from outdoor unit to each floor is also reduced.

**V series :**  
14HP+14HP (2 outdoor units)

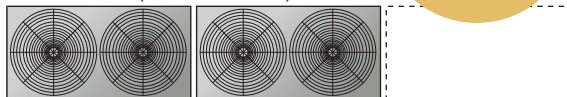

**Conventional model :**  
10HP+10HP+8HP (3 outdoor units)

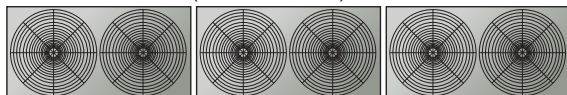

Example : 28HP system installation

Foot print  
**33%**  
less

## Low outdoor air temperature operation

Expansion of operating ranges

World's top class low outdoor air temperature operating range is achieved. This extends the potential locations for use to the cold regions of the world.

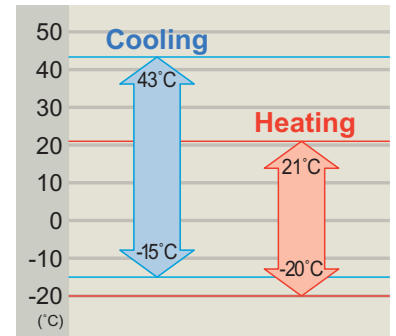
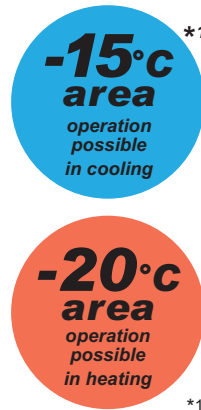

\*1 Note : When outdoor units connect multiple, operating range is from -5°C to 43°C in cooling.

## Communication wire method

Connection method simplifies installation and prevents errors

By using our non polar wiring connection method, the wiring length is reduced compared to other wiring systems.

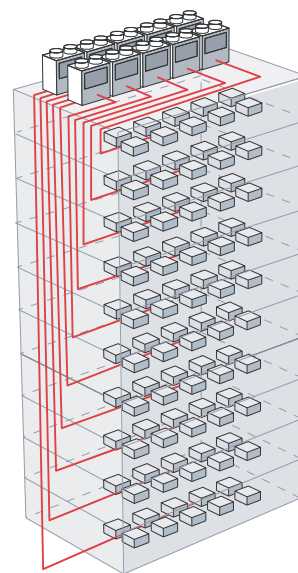

Other wiring method

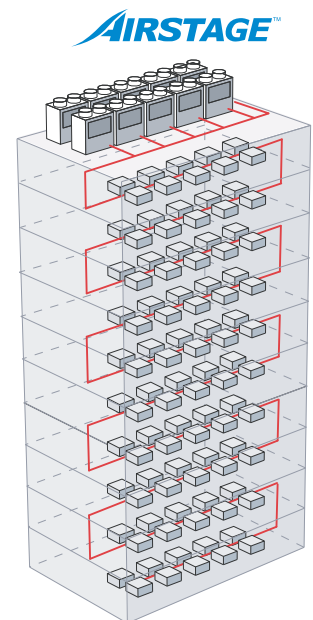

Simple wiring method

# High efficiency operation system



## High COP

All key features of the outdoor unit give a realization to the higher level of COP

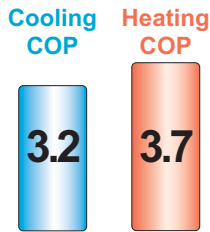

\* The data are available for 10HP master unit.

## High efficiency refrigerant R410A



Reduction of environmental load and improvement of operation efficiency realized by adoption of a new refrigerant



## Sine-wave DC Inverter

Sine-wave DC inverter smoothly controls operation from low speed to high speed

Energy saving and high efficiency operation were achieved by adopting sine-wave DC inverter control to smooth motor operation.



## DC inverter control compressor

High efficiency operation realized by adoption of high pressure scroll compressor

An energy saving and high efficiency operation system is realized by combining a DC inverter-controlled scroll compressor with a constant speed scroll compressor.



## Effective use of the heat exchanger of other outdoor units

This system takes advantage of the features of the multi type outdoor unit.

The heat exchanger is operated at maximum efficiency by effectively using the heat exchanger of each outdoor unit reciprocally.

### Example

The larger heat exchanger than the capacity of a compressor is used in each outdoor unit.

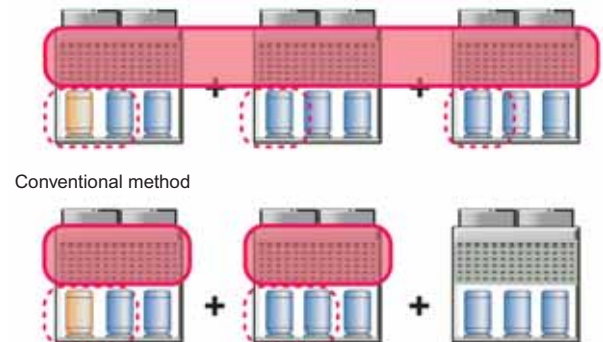

## SERVICE AND MAINTAINABILITY

User friendly design features allows quick response in the unlikely event that trouble occurs

## Service tool Software UTR-YSTC

Dedicated maintenance and inspection tools are available

The sensor data of each part can be collected from the computer at a minimum short interval when connected anywhere on the VRF network. The connection is made through an extremely portable and convenient USB type adaptor and this ensures that response times are reduced to a minimum when issues are identified and test operations can be carried out proactively.



Equipment detail (Diagram)





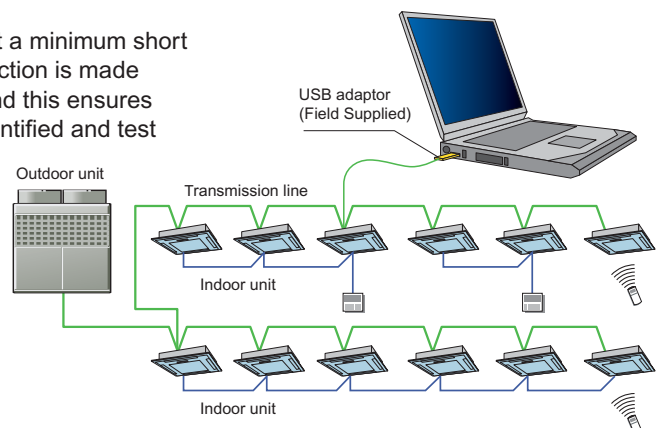





















System list



# Broad range of indoor units of many designs and capacity ranges

## Indoor unit capacity range

Capacity range(kW) ▶	2.15	2.8	3.6	4.05	5.3	5.7
▼ Type Model code ▶	7	9	12	14	18	20
<b>Compact Cassette</b> Compact size panel (600 x 600 mm) design that fits well for European ceiling panel.	 AUXB07LATF	 AUXB09LATF	 AUXB12LATF	 AUXB14LATF	 AUXB18LATF	
<b>Slim Type Cassette</b> Since the unit height of ceiling void part is changeable up to 35 mm, installation is easy. By detachable suction grill, filter is easily cleaned.						 AU *A20LATF
<b>Silent model Compact Duct</b> It is a small-sized and quiet duct type indoor unit which changes a room into the comfortable space.	 ARXB07LALF	 ARXB09LALF	 ARXB12LALF	 ARXB14LALF	 ARXB18LALF	
<b>Silent model Low Static Pressure Duct</b> It is possible to install in the narrow ceiling space, at the 270mm height with slim design.						
<b>Duct</b> Slim type design makes it optimum to install in the room where ceiling void is narrow.						
<b>High Static Pressure Duct</b> This indoor unit can send a large air flow with long ducts.						
<b>Floor / Ceiling</b> The slim and lightweight design allows the unit to be suspended from the ceiling or installed on the floor. This type is easy to fit the room design.			 AB *A12LATF	 AB *A14LATF	 AB *A18LATF	
<b>Ceiling</b> Since it is ultra-thin design, it matches perfectly with the interior design if it is suspended from the ceiling.						
<b>Comfort model Compact Wall Mounted</b> This is recommended as the room where quietness is required.	 AS *E07LACF	 AS *E09LACF	 AS *E12LACF	 AS *E14LACF		
With this model, connection of EV kit is necessary.						
<b>Wall Mounted</b> Double auto swing louver provides pleasant air flow to every corner of the room.					 AS *A18LATF	
<b>Ceiling Wall</b> Since it is installed on the wall near the ceiling, the wall face design will also be clear and neat.	 AW *A07LATF	 AW *A09LATF	 AW *A12LATF	 AW *A14LATF	 AW *A18LATF	



**available which can be selected to suit any air conditioning needs**

6.8 24	7.05 25	8.8 30	10.5 36	12.7 45	14.1 54	17.0 60	25.4 90
	 Slim Type AU *A25LATF	 Slim Type AU *A30LATF	 AU *A36LATF	 AU *A45LATF	 AU *A54LATF		
	 ARXB25LATF	 ARXB30LATF	 ARXB36LATF	 ARXB45LATF			
	 ARXA25LATF	 ARXA30LATF	 ARXA36LATF	 ARXA45LATF			
			 ARXC36LATF	 ARXC45LATF		 ARXC60LATF	 ARXC90LATF
 AB *A24LATF							
		 AB *A30LATF	 AB *A36LATF	 AB *A45LATF	 AB *A54LATF		
 AS *A24LATF		 AS *A30LATF					
 AW *A24LATF		 AW *A30LATF					

*It supports every user's needs by offering a variety of control systems available, such as individual control, central control and building management system*

## Central Control

### 1 PC Controller Software

UTR-YOTB Option

Computes the air conditioning electricity charge for each tenant of building.



### 2 Central Remote Controller

UTB-YCA / UTB-GCA Option

It is compact body and controls many indoor units (Up to 400 units).



### 3 Group Remote Controller

UTB-YDB / UTB-GDB Option

Centrally controls up to 8 remote controller groups (Up to 96 indoor units).



\* For connecting to VRF System, network converter (UTR-YRDA) is necessary. Also, the maximum of 4 units of group remote controllers can be connected to this converter.

## System Diagram

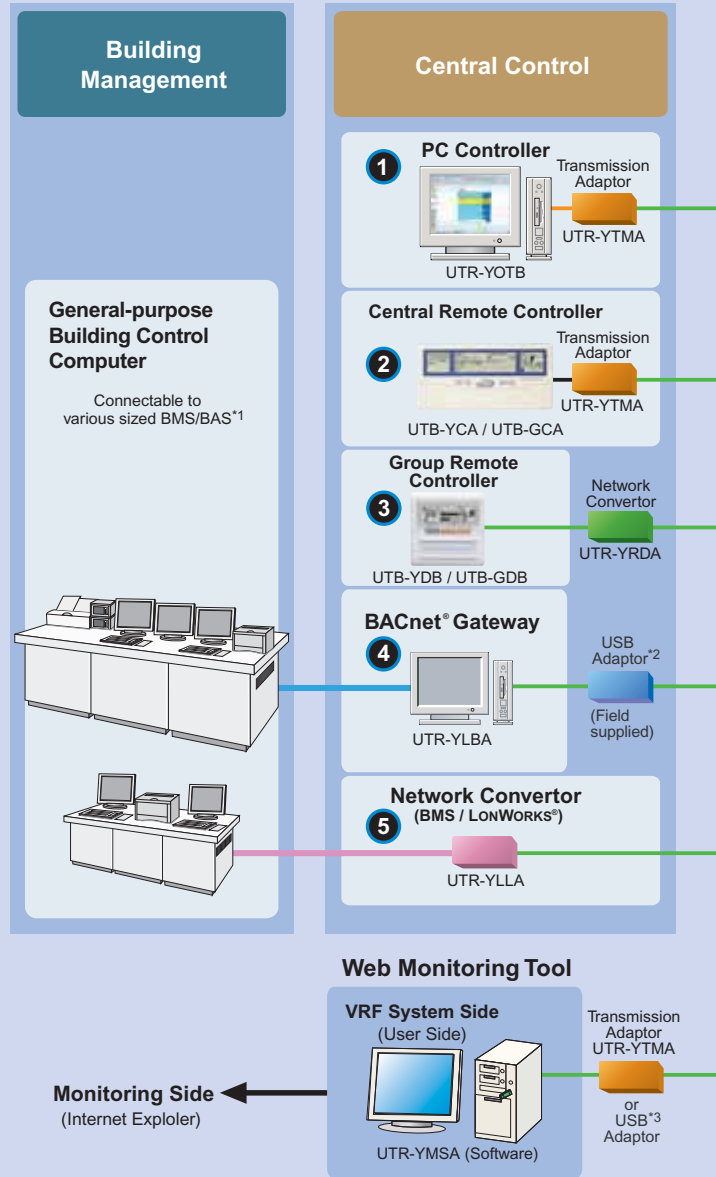

\*1. BMS/BAS: Building Management System / Building Automation System

\*2. USB Adaptor is XLON® USB Adaptor of DH Electronics.

\*3. USB Adaptor is U10 USB Network Interface of Echelon® Corporation.

## Cooperation with Building Management System

Adopting BACnet®, the open network with high versatility renowned in the world, it can connect VRF system and BMS/BAS.

### 4 BACnet® Gateway Software

UTR-YLBA Option

Max. Connectable Indoor Units  
**1600**

it can cope with the requirements of the systems in the high-rise buildings.

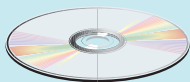

CD-ROM (Software)



Software Protection Key

### 5 LON WORKS® Option

UTR-YLLA

Max. Connectable Indoor Units  
**128**

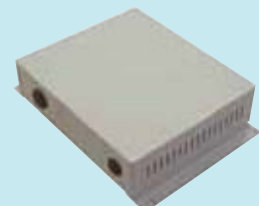

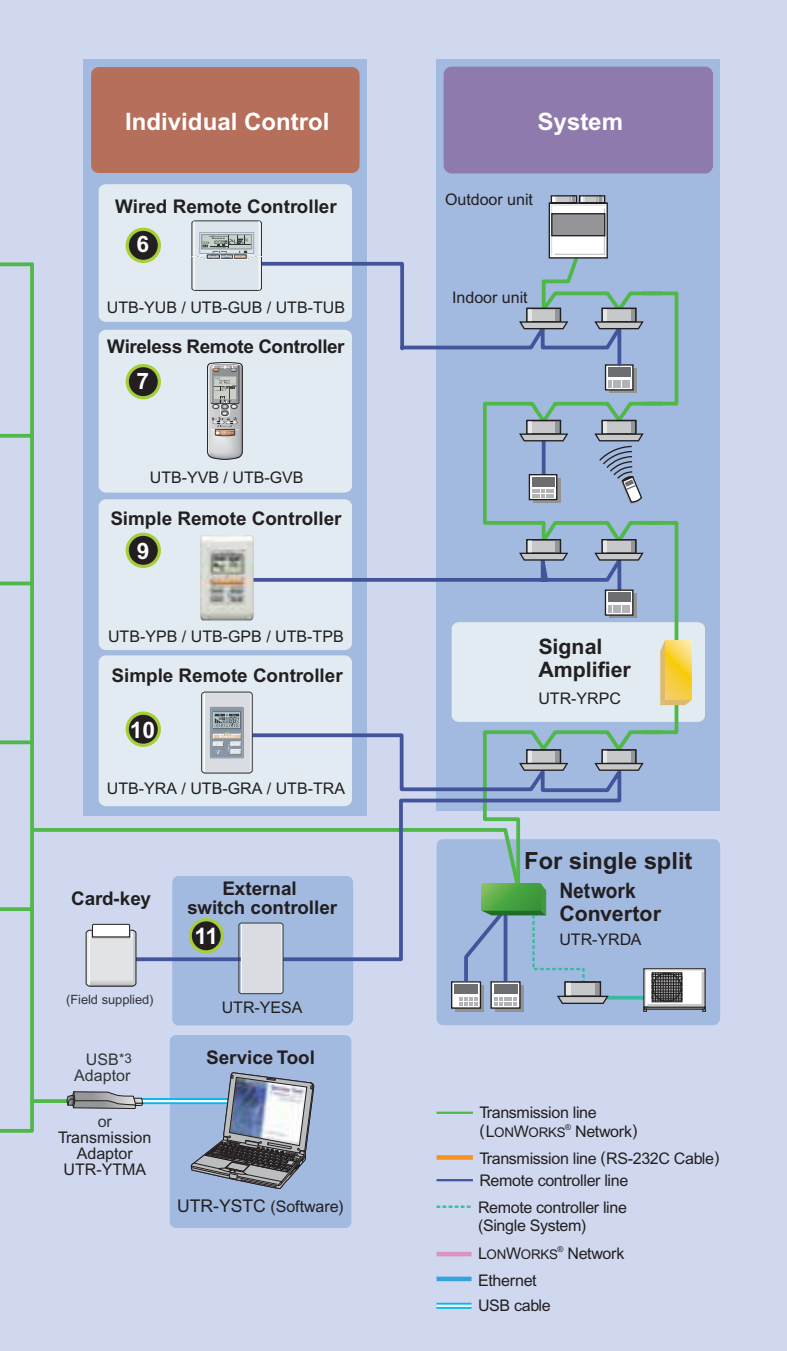

## Individual Control

### 6 Wired Remote Controller

UTB-YUB / UTB-GUB / UTB-TUB **Option**

Operates the air conditioning system for a week according to the plan by built-in weekly timer.

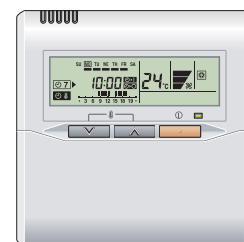

### 7 Wireless Remote Controller

UTB-YVB / UTB-GVB **Option**

It can be used at your hand. 4 types of timers can be used easily.



### 8 IR Receiver Unit

UTB-YWA **Option**

By connecting receiver unit, duct type indoor unit can be controlled with wireless remote controller.

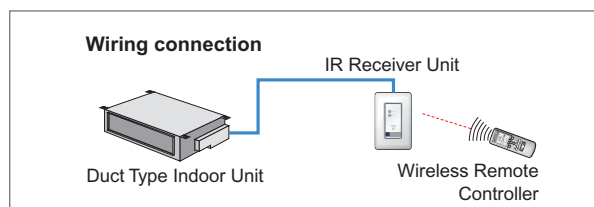

### 11 External Switch Controller

UTR-YESA **Option**

Air conditioner switching can be controlled by connecting other sensor switches.

\*Card-key and other sensor switches are available as a field supplied parts.



### 10 Simple Remote Controller without master control

UTB-YRA / UTB-GRA / UTB-TRA **Option**

Suitable for guest room since its display is easy to see even in the dark room with the basic functions.





### 9 Simple Remote Controller

UTB-YPB / UTB-GPB / UTB-TPB **Option**

Designed to be easy operation for guest.



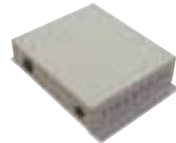





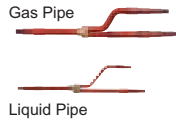
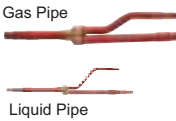
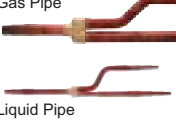
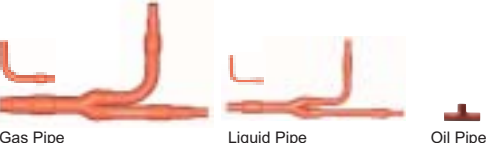
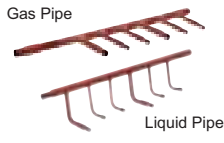
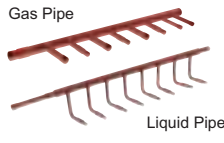

**Adaptor / Converter**

<p>For Single Split or Group Remote Controller</p>  <p><b>Network Converter</b> Model : UTR-YRDA</p>	 <p><b>Network Converter</b> Model : UTR-YLLA</p>	 <p><b>Transmission Adaptor</b> Model : UTR-YTMA</p>	 <p><b>Signal Amplifier</b> Model : UTR-YRPC</p>
---	--	--	---

**Connection Tube**

 <p><b>Separation Tube</b> Model : UTR-BP090L</p>	 <p><b>Separation Tube</b> Model : UTR-BP180L</p>	 <p><b>Separation Tube</b> Model : UTR-BP567L</p>
 <p><b>Outdoor Unit Branch kit</b> Model : UTR-CP567L</p>	 <p><b>Header</b> Model : UTR-H0906L UTR-H1806L</p>	 <p><b>Header</b> Model : UTR-H0908L UTR-H1808L</p>

**Others**

<p>For Low Static Pressure Duct Type / Duct Type</p>  <p><b>Flange (Square)</b> Model : UTD-SF045T</p>	<p>For Low Static Pressure Duct Type / Duct Type</p>  <p><b>Flange (Round)</b> Model : UTD-RF204</p>	<p>For Low Static Pressure Duct Type / Duct Type</p>  <p><b>Long-life Filter</b> Model : UTD-LF25NA</p>	<p>For High Static Pressure Duct Type</p>  <p><b>Long-life Filter</b> Model : UTD-LF60KA</p>
<p>For Ceiling Type</p>  <p><b>Drain Water Riser Kit</b> Model : UTR-DPB24T</p>	 <p><b>Remote Sensor Unit</b> Model : UTD-RS100</p>	<p>For Compact Cassette Type</p>  <p><b>Grille Kit</b> Model : UTG-UDYD-W UTG-UDGD-W</p>	<p>For Compact Wall Mounted (Comfort Model) Type</p>  <p><b>EV Kit</b> Model code &lt; 09 :UTR-EV09XA Model code ≥ 12 :UTR-EV14XA</p>

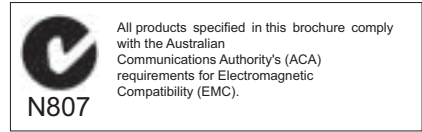
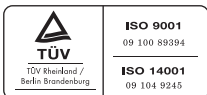

ISO 9001  
Certified number:09 100 79269  
Fujitsu General (Shanghai) Co., Ltd.

ISO 14001  
Certified number:104692  
Fujitsu General (Shanghai) Co., Ltd.

ISO 9001  
Certified number:09 100 89394  
Fujitsu General (Thailand) Co., Ltd.

ISO 14001  
Certified number:09 104 9245  
Fujitsu General (Thailand) Co., Ltd.

**AIRSTAGE™** is a worldwide trademark of FUJITSU GENERAL LIMITED.  
 \*Echelon®, LON®, LONWORKS®, and the Echelon logo are trademarks of Echelon Corporation registered in the United States and other countries.  
 \*BACnet® is a registered trademark of the American Society of Heating Refrigeration and Air Conditioning Engineers (ASHRAE).

Product specifications are subject to change without notice. Copyright © 2006-2007 Fujitsu General Limited. All rights reserved.  
 Distributed by :