



WSAT-XEE

**82-102-122-162-
182-222-262-302**

AIR COOLED WATER CHILLER FOR OUTDOOR INSTALLATION

Installation and Use Manual

UNIT IDENTIFICATION	4
INSTRUCTIONS FOR THE USER	5
COMMON CAUSES OF SHUTDOWN	5
GENERAL WARNINGS	8
RESIDUAL RISKS	9
RECEPTION	12
INSPECTION UPON RECEPTION.....	12
STORAGE	12
HANDLING	12
POSITIONING	13
GENERAL.....	13
FUNCTIONAL CLEARANCES.....	13
POSITIONING	13
WATER CONNECTIONS	15
GENERAL.....	15
EXCHANGER USE SIDE	15
DIAGRAM OF RECOMMENDED USE SIDE CONNECTION.....	16
RECOVERY EXCHANGER.....	16
ELECTRICAL CONNECTION	17
GENERAL.....	17
STANDARD UNIT ELECTRICAL DATA	17
CONNECTION TO THE MAINS	17
FUNCTIONAL CONNECTIONS.....	18
SYSTEM COMPOSITION.....	19
START-UP	21
PRELIMINARY CHECKS.....	21
REFRIGERANT SYSTEM	21
WATER SYSTEM	21
ELECTRICAL SYSTEM	21
VERIFY tensions – absorptions.....	21
UNIT EQUIPPED WITH SCROLL COMPRESSORS	22
REMOTE INPUT CONFIGURATIONS	22
SETTING THE SET-POINT	22
EVAPORATOR WATER FLOW RATE	22
REFRIGERANT CIRCUIT PARAMETER CHECK.....	22
CONTROL	23
OPERING MODES	23
CHARACTERISTICS.....	23
SET POINT.....	24
KEYPAD	25
ROUTINE MAINTENANCE	29
MAINTENANCE INSPECTIONS.....	30
97/23 CE PED directive	30
PUT AT REST.....	30
REFRIGERANT TABLES	31
TROUBLESHOOTING	33
DECOMMISSIONING OF THE UNIT	36
DISCONNECTING THE UNIT	36
DISMANTLING AND DISPOSAL	36
TECHNICAL DATA	37
DIMENSIONS	39

UNIT IDENTIFICATION

SERIAL NUMBER LABEL

The units are identified by the serial number label shown here.

The label lists the type of unit (series and size), serial number, year of manufacture, number of electrical diagram, main technical data, logo and address of the manufacturer.

The label is placed on the unit, generally near the electrical panel and also on the external panelling.

IT MUST NEVER BE REMOVED.

SERIAL NUMBER

This provides unique identification of the machine. It makes it possible to trace the specific features of the unit and to identify the components installed in it.

Without this number, it is not possible to identify with certainty the spare parts that are specific to that unit.

When requesting assistance, always provide the type of machine and the serial number.

Write them in the space below so that they are readily available when needed.

Type of unit : _____

Serial number : _____

Wiring diagram : _____

Year of manufacture : _____

<div style="display: flex; justify-content: space-around; align-items: center;"> <div style="border: 1px dashed black; padding: 5px; font-weight: bold; font-size: 1.2em;">LOGO</div> <div style="font-size: 2em; font-weight: bold;">CE</div> </div>	
TIPO TYPE/TYP TYPE/TIPO	
NUMERO MATRICOLA SERIAL NUMBER / SERIENNUMMER NUMERO DE SERIE / NUMERO DE SERIE	
ANNO DI FABBRICAZIONE YEAR OF MANUFACTURE / BAUJAHR ANNEE DE FABRICATION/AÑO DE FABRICACIÓN	
REFRIGERANTE REFRIGERANT / KÄLTEMITTEL REFRIGERANT / REFRIGERANTE	GRUPPO (PED) GROUP / GRUPE GROUPE / GRUPO
CARICA REFRIGERANTE REFRIG. CHARGE / KÄLTEMITTELFÜLLUNG CHARGE REFRIG./CARGA REFRIG.	Kg
TENSIONE VOLTAGE / SPANNUNG TENSION / TENSION	V/Ph/Hz
F.L.A.	A
F.L.I.	kW
SCHEMA ELETTRICO WIRING DIAGRAM / SCHALTPLAN SCHEMA ELECTRIQUE/ESQUEMA ELÉCTRICO	
PRESSIONE MASSIMA ESERCIZIO MAX OPERATING PRESS. / MAX BETRIEBSDRUCK PRESS. DE SERVICE MAX/PRESION DE EJERCICIO MÁX	
CATEGORIA PED PED CATEGORY / PED KATEGORIE CATÉGORIE PED / CATEGORÍA PED	PS H/L bar
TEMP.LATO BP TEMPERATURE ON LP SIDE / TEMP. ND-SEITE TEMP. COTE BP / TEMP. PARTE BP	
INDIRIZZO / ADDRESS / ADRESSE / ADRESSE / DIRECCION	

INSTRUCTIONS FOR THE USER

- **This is a partial sintex of the information provided in the manual; carefully read this manual**
- Carefully read this manual. Keep it with the electrical diagram. Make it available to technicians for servicing.
- Ask the installer for training on start-up, shutdown, changing set points, placing in at-rest status, maintenance, what to do or not to do in the event of a breakdown.
- Provide for scheduled maintenance by specialized technicians so as to ensure long-lasting operation of the unit.
- If you expect the machine to be shut down for long periods of time, disconnect the electrical power supply. In winter, take necessary measures to deal with possible freezing (unit and system pipes) .

PRINCIPLE OF OPERATION

SUMMER: the cooling cycle allows the transfer of excess indoor heat to the external environment.

1. The compressor compresses the refrigerant gas, placing it at high pressure and high temperature.
2. In the external coil, the refrigerant is cooled, and the heat is released into the environment by means of the fan. This is why the coil needs to be kept clean and free of obstacles.
3. When it cools, the refrigerant becomes liquid.
4. The expansion valve causes a sudden drop in the pressure of the refrigerant, which becomes very cold as its volume increases.
5. In the exchanger, the refrigerant evaporates and absorbs the heat from the water that returns to the system, cooling it.

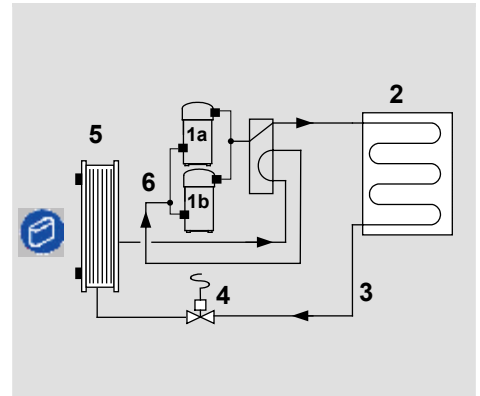

COMMON CAUSES OF SHUTDOWN

1. coils dirty - clogged by leaves - nearby obstacles
2. set point too low (in summer)
3. water in system is too hot (in summer, for example with machine left off over the weekend) or too cold (in winter)
4. water filter dirty
5. external permissions (remote ON-OFF etc.)
6. water cut-off valves closed
7. system not pressurized - air needs to be vented
8. system pump off
9. unit exchanger dirty
10. fans blocked by snow

TO DO FOR

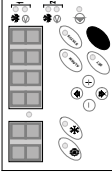
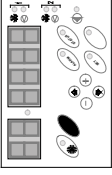
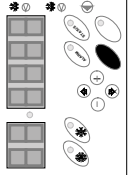
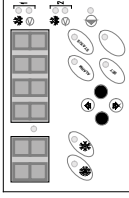
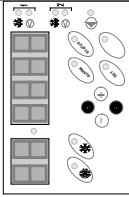
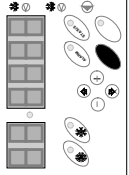
<p>Start the unit possible also by external enabling (see ELECTRICAL CONNECTIONS)</p>	<p>LONG pressing of the ON/OFF button</p>	
<p>Choose the SUMMER mode possible also by external enabling (see ELECTRICAL CONNECTIONS)</p>	<p>“SNOW-FLAKE” button</p>	
<p>Limit the energetic consumption Control by external enabling (see ELECTRICAL CONNECTIONS)</p>	<p>ECO mode</p>	
<p>Minimize the consumptions maintaining the system at a safety temperature in SUMMER (MAINTENANCE function)</p>	<p>Put the unit in OFF (parameter 44 must be = 1)</p>	
<p>Modify the water temp. in COOLING</p>	<p>Control parameter 32</p>	
<p>Modify the water temp. in ECO cooling</p>	<p>Control parameter 29</p>	
<p>Modify the water temp. in MAINTENANCE cooling</p>	<p>Control parameter 42</p>	
<p>Enable (par=1) / disabled (par=0) the MAINTENANCE function</p>	<p>Par 44 SUMMER, par 45 WINTER</p>	
		<p>SET button</p>
		<p>Scroll the parameters</p>
		<p>Modify the parameter</p>
		<p>Back to the main menu</p>

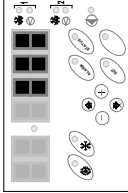
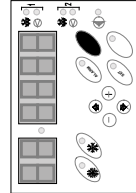
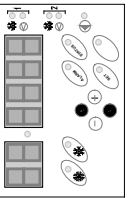
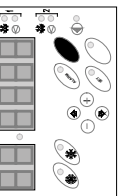
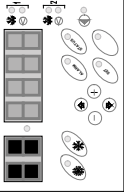
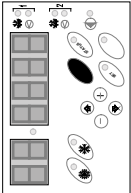
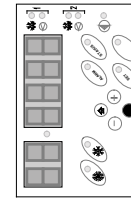
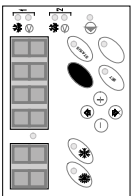
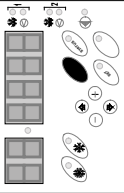
See the OUTPUT temperature from the unit	It is automatically visualized	
See INPUT temp. to the unit	Status num. 9	 <p>STATUS button</p>  <p>Move on different STATUS</p>  <p>To go back to the initial point</p>
See which ALARM blocks the unit	E xx is automatically visualized	
See the alarm log (starting from the most recent until the farthest one)	SHORT pressing of ALARM	 <p>To see the different ARROW DOWN alarms</p>  <p>To go back to the initial point, SHORT pressing of ALARM</p> 
To reset the current alarm ONLY AFTER THE CAUSE ELIMINATION !	LONG pressing of ALARM	 <p>LONG pressing of ALARM</p>

GENERAL WARNINGS

MANUAL PURPOSE

This manual has been designed to enable the unit to be installed, started up and maintained correctly.

MANUAL INSTRUCTIONS

It is essential to observe these instructions.

The manufacturer declines all liability for any damage that may be caused whether directly or indirectly to persons or things if these instructions are not heeded.

MANUAL STORE

This manual and the unit's wiring diagram should be carefully stored so that they are readily available to the operator when required.

EXPERT PERSONAL

The unit must be installed, tested and maintained by expert personal who meet the relevant legal requirements (Italian law No. 46 of 5/3/1990).

LOCAL SAFETY REGULATION INSTALLATION

The installation must be performed observing the local safety regulations.

POWER SUPPLY

Make sure the power supply conforms to the data on the unit's rating plate, located inside the door of the main electrical panel.

PACKAGING

The packaging material (plastic bags, polystyrene foam, nails, etc.) is potentially dangerous and should therefore be kept away from children and recycled in compliance with the local regulations in force.

MAINTENANCE

Before performing any service operations, cut off the power. Perform the operations in conformity with the local regulations in force.

PERIODICAL INSPECTIONS

Perform periodical inspections to locate possible loosened or broken parts. If the repairs are not performed, there will be a higher risk for things and peoples to become damaged and injured.

FAULT – POOR OPERATION

Switch off the unit in the event of faults or poor operation.

REPAIR

Only have repairs carried out by a service centre authorised by the manufacturer, and insist on the use of original spare parts only.

Failure to comply with the above may compromise the safety of the unit.

MODIFICATIONS

The manufacturer will not accept any responsibility, and the warranty will lapse, in the event of electric and/or mechanical modifications. Any modification which is not formally authorized, and which does not respect the instructions given in this manual, will cause the warranty to lapse.

INTENDED USE

The unit must only be used for the specific purpose it was designed :

The unit is designed to cool/heat water or a water and glycol mix for air-conditioning, within the limits defined in the technical bulletin and this manual.

Any use other than that specified does not imply any commitment or constraint by the manufacturer in any way whatsoever.

ADDITIONAL SAFETY PRECAUTIONS

This unit has been especially designed and manufactured so to prevent any risk to persons and health hazard.

For this reason, design solutions fit to eliminate (where possible) any cause of risk and sensibly reduce the probability of danger have been adopted.

Please refer to the "Residual Risks" section of this manual and strictly observe the behaviour prescriptions listed there in order to prevent any possible risk that hasn't been possible to avoid in the design stage.

DATA UPDATING

The manufacturer may be able to modify the data without prior notice as a consequence of constant improvements.

REGULATIONS AND CERTIFICATIONS

UNI EN ISO 9001 CERTIFICATION

Clivet S.p.A., in order to guarantee customer satisfaction, has chosen the ISO 9001 Quality System as the reference for all its business activities. This is demonstrated by the company's commitment to ongoing improvements in the quality and reliability of its products; its sales, design, purchasing, production and after-sales service activities are the means used to reach such purpose.

CE MARK



Clivet products bear the CE mark, in compliance with the requirements of the following EC directives, including the latest amendments, and with the corresponding national approximated legislation:

- - 98/37/CE
- - 89/336/CEE as modified by the directives 92/31/CEE and 93/68/CEE
- - 73/23/CEE as modified by the directive 93/68/CEE
- - 97/23/CE

RESIDUAL RISKS

GENERAL

This section lists some of the more common situations which, being beyond the control of the manufacturer, could be a source of risk to persons or property.

DANGER AREA

The figure below highlights the area in which only authorised personnel may operate.

- **External danger zone**, identified by a precise area around the unit and its vertical projection on the ground in the case of hanging unit.
- **Internal danger zone**, identified by the area that can be entered only after having intentionally removed the protecting panels or parts of these.

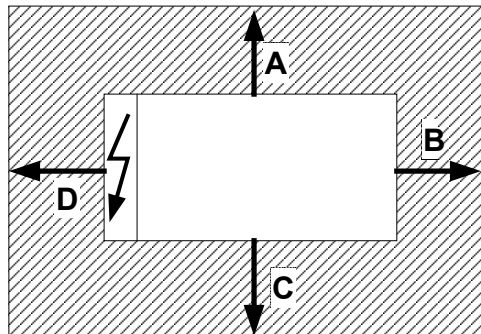

A = 2000 mm

B = 2000 mm

C = 2000 mm

D = 2000 mm

HANDLING

If handling operations are undertaken without adopting all the necessary safety procedures and exercising due care, the unit can fall or topple, causing damage — possibly extremely serious — to persons and/or property, and to the unit itself.

Ensure the unit is handled and manoeuvred as directed on the packing and in the present manual, and in accordance with local regulations.

In the event of refrigerant gas escaping, refer to the “Safety datasheet” for the particular refrigerant.

INSTALLATION

Incorrect installation of the unit can result in water leaks, accumulation of condensate, escape of refrigerant, electric shocks, fire, as well as irregular operation or damage to the unit itself.

Make certain that the installation is carried out only by a qualified technician, also that the directions contained in this manual are followed and local statutory regulations observed.

In the event of the unit being installed in a site where there is even the slightest risk of inflammable gas escapes and consequently the possibility of such gases accumulating in area around the unit, the risk of explosion and fire cannot be discounted.

Take every care and precaution when selecting the installation site.

Installation on a structure not able to bear the weight and/or afford a secure anchorage of the equipment may cause the unit to fall and/or topple, resulting in damage to persons or property, or to the unit itself. Make certain that every care

and precaution is taken when positioning and securing the unit.

If the unit is easily accessible to children, unauthorized persons or animals, this is a situation that can give rise to accidents and injuries, perhaps serious. Install the unit in a place where access is allowed only to authorized persons, or install barriers or guards preventing unauthorized entry.

GENERAL RISKS

A smell of burning, smoke or other indications of serious irregularity could signal the onset of situations liable to cause damage to persons or property or to the unit itself. Isolate the unit from the electrical power supply (red-and-yellow) switch.

Contact an authorized service centre so that the source of the problem can be identified and remedied.

Accidental contact with heat exchange coils, compressors, pressure pipelines or other components can result in wounding or burns, or both.

Always wear suitable clothing, including protective gloves, when working in the danger area.

Maintenance or repairs carried out by unskilled operatives can result in harm or damage to persons and property, or to the unit itself. Always contact an authorized service centre.

Failure to close the panels of the unit, or to check that all the fixing screws of the panels are properly tightened, can result in harm or damage to persons or property, or to the unit itself.

Verify periodically that all panels are closed and made properly secure.

In the event of fire, the temperature of the refrigerant can rise to the point that pressure will exceed safety levels and perhaps cause fluid to be projected. It may also happen that parts of the circuit isolated by closed valves will explode.

Do not stand near safety valves, and never leave the valves of the refrigerant circuit closed.

ELECTRICAL SYSTEM

If the power line connecting the unit to the a.c. supply is incomplete, or if the connection is made with cables of incorrect cross section and/or with insufficiently rated protective devices, this can result in electric shock, toxicity hazard, damage to the unit or fire.

All work on the electrical system should be carried out referring to the wiring diagram and to the directions given in this manual, and the system itself must be dedicated.

Failure to secure the cover enclosing electrical components can lead to the infiltration of dust and water, ultimately causing electric shocks, damage to the unit, or fire.

Always fasten the cover securely to the unit.

If live metal parts of the unit are not connected properly to the earth system, they can cause electric shock or even death by electrocution.

Make absolutely certain that the connection to the earth system is made in accordance with correct practice.

Contact with live parts rendered accessible internally of the unit when the guards are removed can result in electric shock, burns or death by electrocution.

Before exposing these parts, make certain the isolating switch on the power line to the unit is set to the OFF position and padlocked, and post a warning sign.

Contact with parts that could become live when the unit is started up can result in electric shock, burns or death by electrocution.

When there is no need for circuits to be powered up, set the isolating switch on the power line to the OFF position, padlock it and post a warning sign.

MOVING PARTS

Contact with the fan rotors can cause injury.

Before removing the protective grilles or the fans themselves, make certain the isolating switch on the power line to the unit is set to the OFF position and padlocked, and post a warning sign.

Before removing the protective grilles or the fans themselves, make certain the isolating switch on the power line to the unit is set to the OFF position and padlocked, and post a warning sign.

REFRIGERANT

In the event of safety valves coming into operation and releasing refrigerant gas, persons in the vicinity can be

injured or suffer toxic effects. Always wear suitable clothing and protective goggles when working in potential hazard areas.

In the event of refrigerant gas escaping, refer to the "Safety datasheet" for the particular refrigerant.

If an open flame or heat source is brought into contact with the refrigerant, or the pressurized gas circuit should overheat (e.g. during welding operations), this can cause explosion or fire. Do not position any heat source within the hazard area.

Maintenance or repair operations involving welding must be carried out with the system emptied of refrigerant.

WATER SYSTEM

Defects affecting pipelines, connections or valves and other control componentry can result in water being leaked or sprayed from the system, occasioning damage to property or causing short circuits in the unit.

Make certain all hydraulic connections are securely made, following the directions given in the present manual.

REFRIGERANT SAFETY CHARGE

		R-410A
01	Identification of the product and of the supplier	Chart No FRIG 8 Product R-410A Identification of the supplier. See heading or bottom of page. No of emergency telephone. See heading or bottom of page.
02	Composition / information on ingredients	Substance/ Compound . Compound Elements / Impurities. It contains the following elements Difluorometan (R32) 50 % in weight Pentafluoroetan (R125) 50 % in weight CEE No Non applicable for mixtures. Commercial name /
03	Hazard identification	Hazard identification. Liquefied gas. Vapours are heavier than air and can cause choking by reducing the oxygen available for breathing. A rapid evaporation of the liquid can cause freezing. It can cause cardiac arrhythmia.
04	First aid measures	Inhalation. Do not administer anything to fainted people. Take to open air. Administer oxygen or practice artificial breathing if necessary. Do not administer adrenaline or similar substances. Contact with eyes. Rinse carefully with plenty of water for at least 15 minutes and consult a doctor. Contact with the skin. Rinse immediately with plenty of water. Immediately take off all contaminated cloths. Ingestion. Way of exposure not very probable.
05	Anti-fire measures	Specific hazards. Pressure increase. Dangerous combustible products. Halogen acids, traces of carbonyl halogens. Extinction means. You can use all extinction means available. Special methods. Cool the containers/tanks with sprays of water. Special protection means. In close spaces, use the self-breather.
06	Measures against the accidental leakages of the product.	Personal protections. Evacuate the personnel in safety areas. Foresee adequate ventilation. Use means of personal protection. Protection for the environment. It evaporates. Methods for eliminating the product. It evaporates.
07	Handling and stocking.	Handling and stocking. Assure a sufficient exchange of air and/or a suction system in work areas. Use only in well-ventilated rooms. Do not breathe vapours or aerosols. Carefully close the containers and keep them in a cool, dry and well-ventilated place. Keep in the original containers. Incompatible products. Explosives, inflammable materials, organic peroxides.
08	Check of the exposition / personal protection	Personal protection. Assure adequate ventilation, especially in closed rooms. Control parameters. Difluorometan (R32): Recommended limits of exposition: AEL (8h and 12h TWA) = 1000 ml/m ³ Pentafluoroetan (R125): Recommended limits of exposition: AEL (8h and 12h TWA) = 1000 ml/m ³ Protection of respiratory tract. For the rescue and for service work in the tanks, use an autonomous breather. Vapours are heavier than the air and can cause choking by reducing the oxygen available for breathing. Protection for the eyes. Total protection glasses. Protection for the hands. Rubber gloves. Hygienic measures. Do not smoke.

09	Chemical -physical properties.	Relative density, gas (air=1) Heavier than air. Solubility in water (mg/l). Not known, but probably very low. Aspect. Colourless liquefied gas. Smell. Simile to ether. Point of ignition. Don't ignite.
10	Stability and reactivity.	Stability and reactivity. No decomposition if used following the instructions. Materials to avoid. Alkaline metals, earth alkaline metals, granulated metal salts, Al, Zn, Be etc. in powder. Dangerous decomposition products. Halogen acids, traces of carbonyl halogens.
11	Toxicological information	Local effects. Concentration substantially above the TLV value (1000 ppm) can cause narcotic effects. Inhalation of products at high concentration decomposition can cause respiratory insufficiency (pulmonary edema). Long-term toxicity. It has shown no carcinogenic, teratogen or mutagenic effects on animal experiments. Specific effects. A rapid evaporation of the liquid can cause freezing. It can cause cardiac arrhythmia.
12	Ecological information	Effects connected to ecotoxicity Pentafluoroetan (R125) Potential of global heating of halocarbides; HGWP; (R-11 = 1) = 0.84 Potential of ozone impoverishment; ODP; (R-11 = 1) = 0
13	Disposal considerations	General considerations. Do not drain where the accumulation can be dangerous Usable as reconditioning. Depressurized containers should be given back to the supplier. Contact the supplier if the use of instructions is necessary.
14	Transport information	Designation for the transport LIQUEFIED GAS N.A.S (DIFLUOROMETAN, PENTAFLUROETAN) UN No 3163 Class/Div 2.2 ADR /RID Nr 2, 2°A No hazard ADR/RID 20 ADR Label. Label 2: not toxic gas not inflammable. CEFIC Groupcard 20g39 - A Other information for the transport. Avoid the transport on vehicles where the loading zone is not separated from the driver compartment. Verify that the driver is informed on the potential risk of the load and that he knows what to do in case of an accident or emergency. Before starting the transport, verify that the load is well fixed and: Verify that the container valve is closed and does not leak Verify that the blind cap of the valve, if supplied, is correctly assembled. Verify that the cap (if supplied) is well assembled and that there is adequate ventilation Verify that the norms in force are respected.
15	Information on the norms in force	The product must be labelled according to the 1999/45/CE normative. Observe the following norms, the relevant updating and the applicable modifications: Circulars no.46/79 and 61/81 of the Work Ministry: risks connected to the use of products containing aromatic amines. Law Decree no. 133/92 : Norms relevant to the draining of dangerous substances in water Law Decree no. 277/91: Protection of workers for noise, lead and amianthus Law 256/74, Ministerial Decree of 28th Jan. 1992, Legislative Decree no 52 of 3rd Feb. 1997, Ministerial Decree of 28 th Apr. 1997 and following modifications: Classification, packaging and labelling of compounds and dangerous substances Decree of the Republic President no.175/88, following modifications and updating: Activities with risks of serious accidents (Seveso Law) Decree of the Republic President no 203/88: Emissions in the atmosphere Decree of the Republic President no.303/56: Hygiene of work Decree of the Republic President no.547/55: Norms concerning the accident prevention Legislative Decree. No.152 of 11th May 1999: Protection of waters.
16	Other information	Suggested uses. Refrigerant. High concentrations can cause asphyxia. Keep in a dry and well-ventilated place. Do not breathe in the gas. The asphyxia risk is often under-evaluated and must be put into evidence during the operator's training.

Verify that all national and regional regulations are observed.

Before using this product in any new process or experiment, a deep study about the safety and the product compatibility with the materials must be performed.

The above information is based on our present know-how and describes the product considering the safety needs. However, they do not represent a guarantee and a warranty of the qualities in a juridical sense. Everyone is personally responsible for the observation of these norms.

Information present in this document is valid at the time of printing. The company is not responsible for any damages caused by the incorrect use of the product and/or for the use in conditions different from the conditions suggested.

RECEPTION

INSPECTION UPON RECEPTION

Check on arrival that the unit has not suffered damage during transit and that it is complete in every part as specified in the order. In the event of visible damage/deficiencies being discovered, make a note immediately on the delivery document with the comment: **CONDITIONAL ACCEPTANCE — CLEAR EVIDENCE OF DEFICIENCIES/DAMAGE DURING TRANSIT**

Inform both the supplier and the carrier of the details by fax and by registered mail with advice of receipt not later than 8 days after taking consignment. Notifications sent after 8 days have elapsed will be ignored.

STORAGE

Shelter from: direct sunlight, rain, sand and wind

Temperature: maximum 60°C minimum -10°C

Maximum humidity: 90%

The respect of the instructions on the exterior side of the packaging assures the physical and functional integrity of the unit for the final user's advantage.

It is recommended to:

- Handle carefully
- Keep in a dry place
- Avoid putting other objects on top of the unit (respect the limits of levels of superimposition shown in the package)
- Avoid placing the unit with thermoretractable protection under the sun since the pressure of the circuits can assume values which activate the safety valves.

HANDLING

The operation of handling the unit must be carried out respecting the instructions of the safety norms in force (Legislative Decree 626/94 and following modifications)

Before starting the handling operations:

- Value the critical points during handling (stairs, flights, disconnected routes, doors, etc)
- Verify that the lifting capacity of the means used is adequate to the unit weight
- Consider that the barycentre could be moved with respect to the center of the unit
- Before starting to lift, verify that the unit is at a stable balance

The following examples are indications; the choice of the means and of the handling modes will depend on factors, such as:

- The unit weight
- Type and overall dimensions of the unit
- Place and route for the handling (dirt yard, asphalted square, etc)
- Condition of the place of destination (roof, square, etc)
- Handling distance characteristics (distances, flights, steps, doors)

LABELS / YELLOW BRACKETS SHOW THE LIFTING POINTS

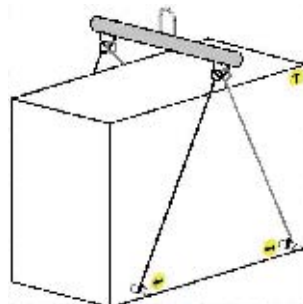
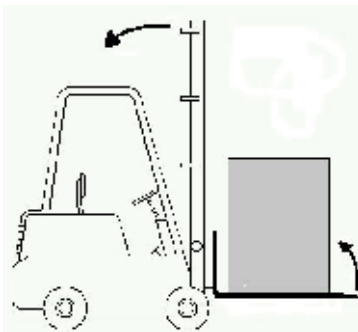

2 lifting points
use 2-arm uprights
(2 slopes/chains/slings per each side of the unit)

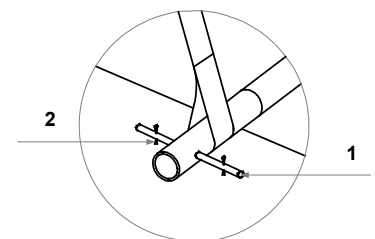

**Insert safety pins (1)
and split pins (2)**

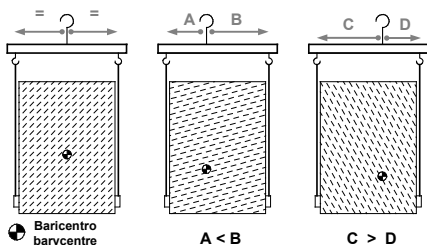

How to balance the charge
Move the upper hook or the lower hooks,
according to the spring equalizer rocker arm type

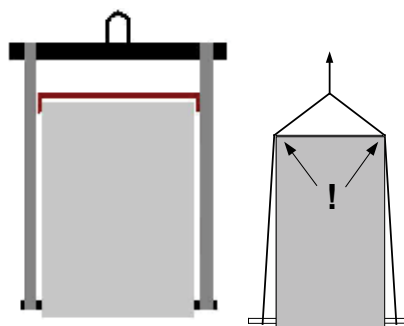

use a spacer bar
to avoid damaging the unit

REMOVING THE PACKING

For removing the packaging, use specific personal protection for the operator (gloves, glasses, etc.).

While removing the packaging, pay attention not to damage the unit.

Check for any visible damage.

Dispose of the packaging by taking it to specialist collection or recycling centres in accordance with local regulations

POSITIONING

GENERAL

For installing air-conditioning systems, it is necessary to consider the following:

- the technical spaces necessary for the machine and system
- the place where the machine will be installed
- the transport of thermal carrier fluids and relevant connections to the unit:
 - water
 - air
 - refrigerant (unit in more sections)
- electrical connections

If these aspects are not evaluated carefully, they can affect the performances and the working life of the unit.

FUNCTIONAL CLEARANCES

When placing the unit, please respect the functional clearances indicated in DIMENSIONS section.

The functional spaces need to be observed because of the following:

- to guarantee the good operation of the unit
- to allow the performance of all maintenance operations
- to protect the authorized operators and exposed people

If more units are placed close to one another, the functional spaces must be doubled.

POSITIONING

1. The units are designed for **OUTDOOR** installations, performed in fixed positions and in areas accessible only to qualified and authorized personnel

2. **SAFETY VALVE** (only if present on the unit) : the installer is responsible for evaluating the opportunity of installing drain tubes, in conformity with the local regulations in force (EN 378)

For the valves fitted directly on the tandem, the pipe must be equipped with antivibration mounts

3. Install the unit **raised** from the ground
4. avoid installations in places subject to **flooding**
5. Consider the maximum level which can be reached by **snow**
6. Verify that the fixing/supporting points are level and suitable to support the **weight of the unit** (see the weight and the weights distribution)
7. It is recommended to put the unit on specific **antivibration devices**

Each support point of the unit sustains a different weight. Therefore, each anti-vibration device is sized for a specific support point, and can only be placed there. The anti-vibration devices must therefore be placed in accordance with the instructions provided with them and with the dimensional drawings in which the support points are indicated by W1 , W2 , W3 etc .

On each anti-vibration device (if provided by CLIVET), its identifying code is stamped, for example C6100100

Flexible joints are necessary on all the hydraulic/ aeraulic connections (the joints are not supplied by Clivet)

8. **Anchor** the unit to the ground; foresee windbreak barriers in case of places where there are strong prevalent winds .

9. The choice of the location of the unit is of fundamental importance for correct operation; to avoid:

- **obstacles** that block the flow of air
- difficulty in air **circulation**
- **leaves** or other objects that may block the exchanger coils
- **winds** that contrast or excessively assist the air flow
- phenomena of **stratification** or air **re-circulation**
- nearby **sources** of heat (chemney, extractor ecc)
- positioning under the round level or near very high walls

The previous situations cause working anomalies or stop the machine and cause:

- during **SUMMER** operation, increase of the condensation pressure with the decay of performances and possible stops due to high pressure.

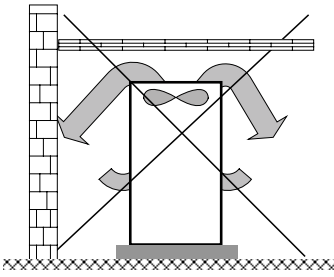

Consider clearances and direction of expelled air.

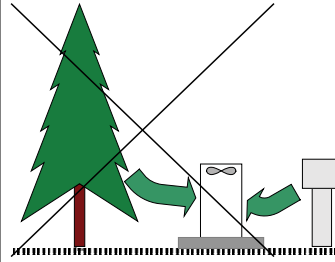
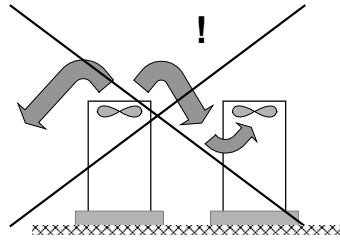

Keep the coil clean. Avoid zones with leaves / dirt / corrosives.

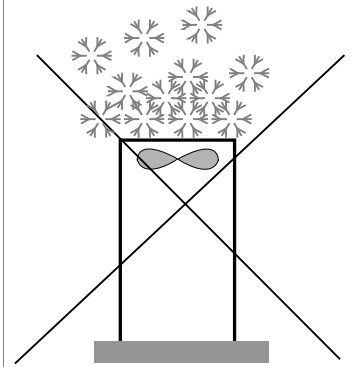

Avoid snow build-up during winter operation

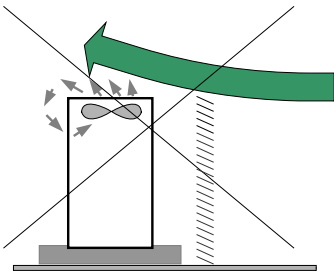

Provide windbreaks in locations with strong winds.

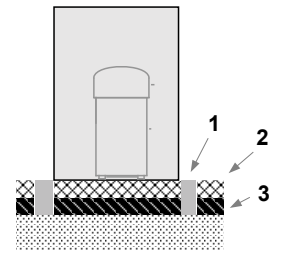
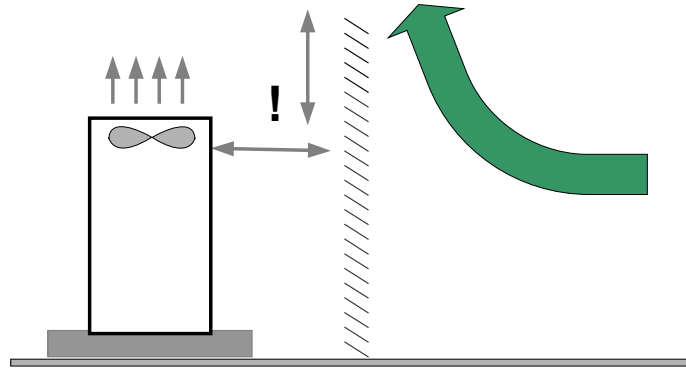

1. elastic joint
2. floating floor
3. soundproofing

Prevent the transmission of vibrations.

WATER CONNECTIONS

GENERAL

Piping must be designed with the least possible number of bends and head variations. If the pressure chute of the installation is above the useful prevalence of the pump, the water delivery capacity is reduced as well as, as a consequence, the thermal exchange and the yield.

INTERCEPTING VALVES

Install on the input and output of the user parts (exchangers, coils, humidifiers, etc) So that it will be possible to carry out all the service operations and possible substitutions without emptying the installation.

PRESSURE AND TEMPERATURE INDICATOR

Install on the input and output of the user parts (exchangers, coils, humidifiers, etc) So that it will be possible to carry out all the service operations.

AUTOMATIC OR MANUAL ESCAPE VALVES

Install the highest points of tubes in a way that the air can escape form the circuit.

BLEEDING COCK

Install them at the lowest points of the circuit, so as to allow emptying.

LEAKAGE TESTS

Before performing the insulation of the tubes, carry out a leakage test.

TUBE INSULATION

All tubes of water must be insulated so that to avoid the formation of condensation and thermal dispersions along the tubes themselves. Verify that the insulation is the vapour coil type. The connections for the air escape and for the emptying must be out of the insulating thickness to assure the accessibilit .

CONNECTIONS SUPPORTS

The weight of the hydraulic connections must be supported in the exterior of the unit so as not to stress the connections of user devices (exchangers, coils, humidifiers, etc) .

ANTI-VIBRATION DEVICES

In case of units with anti-vibration devices, it is necessary to assemble elastic joints, even on water connections.

RISK OF FREEZE

If the unit and the relevant water connections are subject to temperatures near 0°C:

- mix the water of the system with glycol
- protect the tubes with heating cables under the tubes insulation
- empty the system by verifying that:
 - no taps are closed so they can not trap the water, even after emptying
 - there are no low points where the water can stagnate even after emptying; blow if necessary

INTALLATION EMPTYING

The refilling of the water present in the installation increase the oxidation phenomena and lime deposits.

If necessary empty only the interested system section and anyway empty or refill the installation if necessary .

EXPANSION TANK

The installation must be kept at the right pressure by both an expansion tank and a combined valve of pressure reduction and discharge; if the components are present on the unit, they must be installed on the installation. The expansion tank must be dimensioned in function of the water in the installation.

MAX. WORKING PRESSURE

- max. water side pressure = **550kPa**

ARIES EFFECTS AND AIR BUBBLES CAN PRODUCE THE OVERCOMING AND CAUSE WATER DROPS

EXCHANGER USE SIDE

FILTER

It is very important for the water to be free of impurities. If it is not, the efficiency of thermal exchange is diminished. In worst cases, the exchanger can be irreparably damaged. If the filter is not present on the machine, it must be immediately installed upstream from the unit, in a position which can be easily reached for cleaning

FLOW SWITCH

The flow switch must be present as a component of the system, so as to ensure shutdown of the unit if water is not circulating. It must be installed in a straight tract of the tubes, not near the elbows, which can generate harmful turbulence

UNFREEZABLE LIQUIDS

If the unit is used when the water temperature is lower than + 4°C, avoid the formation of ice by using unfreezable liquids (ex. Ethilenic Glycol) in the necessary percentage. The use must also be determined for ambient temperatures near 0°C .

ANTIFREEZE HEATERS

If the unit is equipped with antifreeze heaters on the exchanger side (standard or optional according to the models), verify that they are electrically fed during periods that the machine is stopped (night, weekends, long stops)

WASHING THE SYSTEM

Carefully wash the system by using clean water and discharge it before connecting the unit.

DIAGRAM OF RECOMMENDED USE SIDE CONNECTION

Depending on the type of machine and the selected setup, some components may be integrated into the unit.

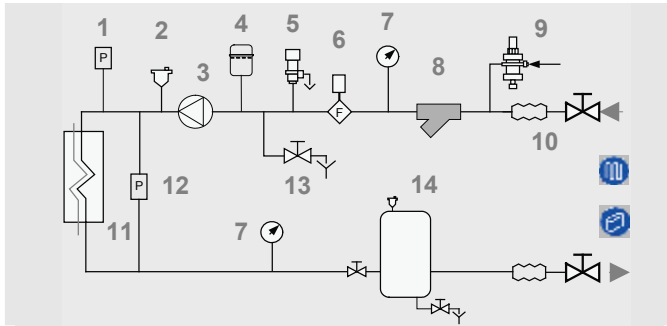

- | | |
|-----------------------------------|----------------------------------|
| 1. Charged system pressure switch | 8. filter |
| 2. vent | 9. filling valve |
| 3. pump | 10. antivibration joints |
| 4. expansion tank | 11. user side exchanger |
| 5. safety valve | 12. Differential pressure switch |
| 6. flow switch | 13. Discharge cock |
| 7. pressure switch / thermometer | 14. inertial storage tank |

The accumulation tank is necessary in the event of the following:

- the water in the system is very low
- the unit will not be used in a private house (in an industrial process or other)

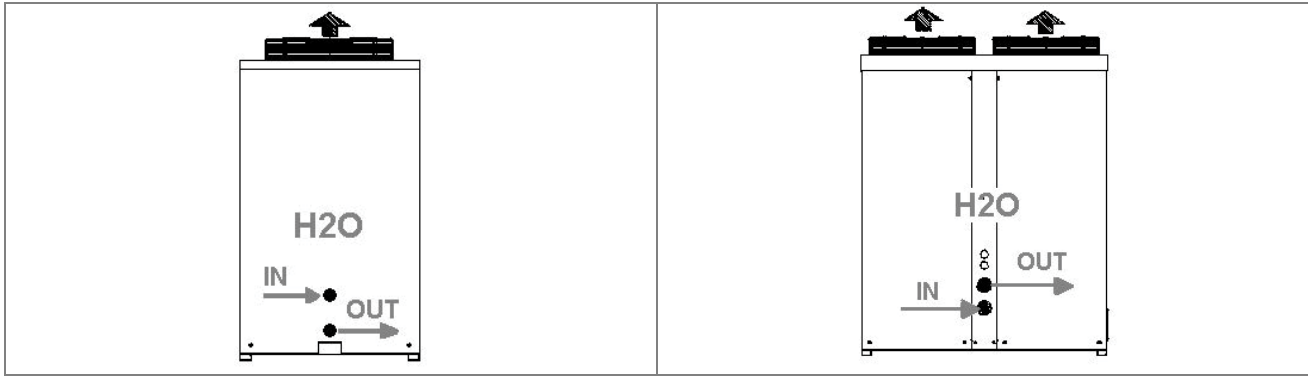

WATER CIRCUIT EMPTYING

The unit is equipped with outlets for the pump emptying and storage. Outlets are accessible from the rear side (left side in the figure).

Storage content: size 82÷122 **80 litres**
 (optional) size 162÷302 **130litres**

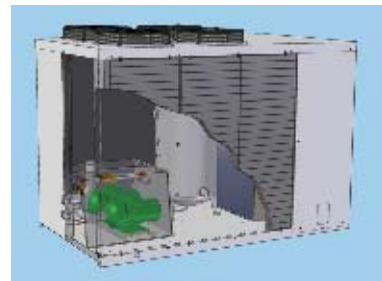

RECOVERY EXCHANGER

OPTIONAL - The unit can be equipped with exchangers to recover the condensation heat.

The recovery can be:

PARTIAL

- with 25% recovery
- The customer is responsible for the management of the circulation pump, valves, thermostats, etc

The recovery input water must not be below 25°C, in the event that, wrongful operations and breakages of the unit can occur .

Water connections must be performed carefully as for the evaporator (filter, circuit washing, etc) .

Perform all necessary interventions to avoid the RISK OF FREEZING (tubes insulation, emptying of circuit, addition of glycol, anti-freeze heaters) .

Water temperature can reach high temperatures (up to 100°C), therefore:

- avoid the RISK OF BURNS by adopting the necessary precautions (insulation of tubes, temperature detecting station on water if the sanitary use is foreseen, etc)
- Install safety valves and specifically dimensioned expansion tanks in the hydraulic circuit.

ELECTRICAL CONNECTION

GENERAL

The characteristics of the electrical lines and relevant components must be determined by SPECIALIZED PERSONNEL ABLE TO DESIGN ELECTRICAL INSTALLATIONS; moreover, the lines must be in conformity with professional procedures and the regulations in force.

All electrical operations should be performed by trained PERSONNEL HAVING THE NECESSARY REQUISITES UNDER LAW and being informed about the risks relevant to these activities.

Before performing any operation on the electrical system, make sure that the unit supply line is SELECTED AT START.

The earth connection must be made prior to other electrical connections.

For all electrical type operations, REFER TO THE ELECTRICAL DIAGRAM ATTACHED TO THE UNIT; the number of the diagram is shown on the registration plate positioned on the electrical board or next to it.

The electrical diagram should be carefully kept together with this manual and should be AVAILABLE FOR FUTURE INTERVENTION ON THE UNIT.

LINE OF UNIT POWER SUPPLY

The ELECTRICAL DATA OF THE UNIT are shown in the technical chart of this manual and on the unit registration plate. The presence of accessories can vary according to the unit; the electrical data shown in the technical chart

refer to standard units. In the event of differences between the data of the registration plate and the data shown in this manual, as well as in the technical chart, please refer to the DATA SHOWN IN THE REGISTRATION PLATE.

The protection device of the unit power supply line should break off the short circuit power whose value should be determined according to the plant features.

The section of supply cables and protection cable must be seized according to the characteristics of the protections used.

SIGNALS / DATA LINES

Do not overpass the maximum power allowed, which varies, according to the type of signal.

Lay the cables far from power cables or cables having a different tension and that are able to emit electromagnetic disturbances.

Do not lay the cable near devices which can generate electromagnetic interferences.

Do not lay the cables parallel to other cables; cable crossings are possible, only if laid at 90°.

Connect the screen to the ground, only if there are no disturbances

Assure the continuity of the screen during the entire extension of the cable.

Observe, if any, the requirements about impedance, capacity, attenuation

STANDARD UNIT ELECTRICAL DATA

VOLTAGE: 400/3/50+N

SIZE		82	102	122	162	182	222	262	302
F.L.A. FULL LOAD CURRENT AT MAX ADMISSIBLE CONDITIONS									
F.L.A. - Circulating pump	A	1.6	1.6	1.6	1.6	1.6	2.7	2.7	2.7
F.L.A. - Total	A	23.6	27.7	31.9	36.7	43.0	52.1	61.0	68.9
F.L.I. FULL LOAD POWER INPUT AT MAX ADMISSIBLE CONDITIONS									
F.L.I. - Circulating pump	kW	0.8	0.8	0.8	0.8	0.8	1.5	1.5	1.5
F.L.I. - Total	kW	13.2	15.4	17.7	20.7	23.9	28.2	32.9	36.6
M.I.C. MAXIMUM INRUSH CURRENT									
M.I.C. - Value	A	77.4	114.4	118.6	131.3	138.3	195.5	204.4	212.3

voltage unbalance: max 2 %

The circulating pump is included in the total values calculation.

For further information on non standard power supply, please contact our Sales Department.

power supply 400/3/50 (+ NEUTRAL) +/- 6%

CONNECTION TO THE MAINS

1. Make sure that the sectioning device at the beginning of the unit's power line is opened, locked and equipped with a signal.
2. Open the general line disconnecting switch (if present)
3. Verify that the net is in conformity with the data shown in the registration plate placed on the electrical board.
4. Check the dimensional drawing for the input of the electrical lines
5. Take away the closing plate placed on the electric board (ONLY IF PRESENT) and drill a hole through it to pass the cables through)
6. Protect the cables, using the fairlead of an adequate size.
7. Using the layout of the electrical diagram, single out the connecting terminals of the electrical supply cables, of the neutral (if foreseen) and the PE protection cable
8. Connect the cables to the relevant terminal boards
9. Before supplying power to the unit, make sure that all the safety devices that were removed during electrical connections are positioned again.

FUNCTIONAL CONNECTIONS

FOR ALL THE CONNECTIONS MAKE REFERENCE TO THE ELECTRICAL PANEL SUPPLIED WITH UNIT

Use voltage-free remote control devices that are suitable to commutate very low loads (12V, 10mA)

Few inputs must be activated by configuration parameters whose access is reserved to authorized assistance centres (in order to avoid unauthorized modifications)

ON / OFF FROM REMOTE CONTROL

Generally the unit is delivered with bridged terminals; if the control is not used, the bridge should not be removed

SECOND SET POINT FROM REMOTE CONTROL (ECO)

Use of a second set point (par 29 cooling), usually higher in summer. The commutation can be also performed manually by keypad.

SIGNALIZATION OF MALFUNCTIONING/ UNIT FUNCTIONING

Remote signalisation of the proper function (ex. green light) or signalisation of blocks of the machine (ex. red light).

Maximum voltage at the terminal ends is 24v ac and maximum power is 1A (ac1) .

SET POINT COMPENSATION WITH 4-20 MA SIGNAL (WATER RESET)

It optimizes the energetic efficiency of the unit by automatically changing the set-point according to an external signal of 4-20 ma type. It requests the **expansion plug-in module** option that must be fitted by the client (refer to the kit instructions) and enabled by parameter 140 = 1. This function must be enabled with parameter 18 (=0 not enabled, =1 only summer, = 2 only winter, = 3 summer and winter)

par	description	meaning	value
18	WaterReset	Water Reset enabling 0=No 1=Cool 2=Heat 3=Always	0
19	MaxCWRH	Max. value of the Winter WR correction	10
20	SWRMAXH	Corresponding signal of the winter MAX. correction	4
21	SWRMinH	Corresponding signal of the winter MIN. correction	20
22	MaxCWRC	Summer correction max. value	8
23	SWRMaxC	Corresponding signal of the summer MAX. correction	20
24	SWRMinC	Corresponding signal of the summer MIN. correction	4
140	PlugInEn	Enables PLUG-IN presence . 1=YES / 0=NO	

SET POINT CURVE IN COOLING

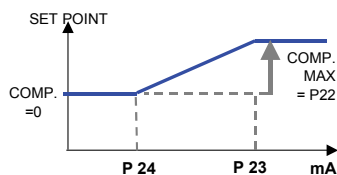

SET POINT COMPENSATION ON THE TEMPERATURE OR EXTERNAL ENTHALPY

Optimises unit energy efficiency by automatically adjusting the set-point according to enthalpy or the outside temperature. Requires the **external humidity probe** or the **outside temperature probe**, which are optional for certain types of units and must be installed by the customer and enabled by parameters 152=1 and 156=1.

par	description	meaning	value
9	CompExt	External temp. comp. enabling 0=No 1=Cool 2=Heat 3=Always	0
10	CextMaxC	Ext. Temp. max. summer correction	15
11	CextMinC	Ext. Temp. min. summer correction	30
14	MaxCExtC	Summer correction max. value	8
16	HExtMinC	Ext. enthalpy min. correction	10,5
17	HExtMaxC	Ext. enthalpy max. correction	13,5
152	TextEn	EXT. Air probe presence 1=YES, 0=NO	
156	URProbeExt	Enables external UR% probe. 1=YES, 0=NO	

SET POINT CURVE IN COOLING

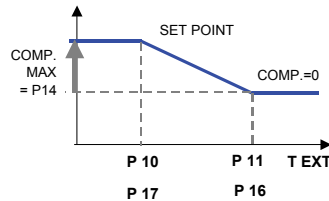

SYSTEM COMPOSITION

The system is composed of the following modules:

Some are optional that could be not installed.

Some are supplied in packages separate from the unit: check the shipping document descriptions.

	<p>LOCAL KEYPAD code C5110799 The interface terminal enables to control every machine function, to program the different adjustment parameters and possibly to display the unit statuses and alarms.</p>
	<p>REMOTE KEYPAD OPTIONAL - Code PE2N0001 The interface terminal enables to control every machine function, to program the different adjustment parameters and possibly to display the unit statuses and alarms. It remotely repeats all functions available on the machine keyboard</p> <ul style="list-style-type: none"> • Max. length 100 metres • POWER SUPPLY 230/1/50 • N. of signal conductors 2 + shield • MIN. SECTION 0.34 MM2
	<p>MAIN ADJUSTMENT MODULE C5110776 It controls unit (inlets, outlets, configuration parameters)</p>
	<p>EXPANSION PLUG-IN MODULE code C5110767 It is connected to the main module by a coupling comb. This may be fitted on the unit depending on the unit type and the accessories that are installed..</p>

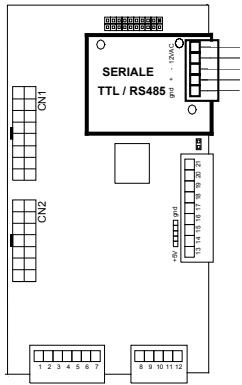

SERIAL CONVERTER TTL/RS485

OPTIONAL - code PE2N0002

Plugged-in in the main module on the electric board (see lay in the wiring diagram). It is possible to connect up to 127 units with a single supervision system.

The connection with a PC must use a RS485/232 converter; the serial line RS232 can be max. 10-m long.

CONNECTIONS:

make reference to the electrical panel and to the SIGNALS AND DATA LINES paragraph

Below the indications for the serial connection ; refer anyway to the CLIVET “RS 485 NETWORKS – GUIDELINES” document and ask for the COMMUNICATION PROTOCOL about the COMPACT-MEDIUM electronics

- The total length of each single serial line, don't have to be over 1000 metres
- The potential difference between the “ground” of two RS485 switches must be less of 7 V
- Couple of conductors twisted and shielded
- Section of conductor 0.22mm²...0,35mm²
- Nominal capacity between conductors < 50 pF/m nominal impedance 120 Ω
- Recommended cable BELDEN 3105 A

TYPE OF NETWORK

The serial lines must be connected in bus typology, i.e. nodes to more points are not admitted

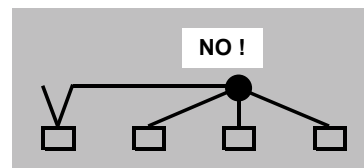
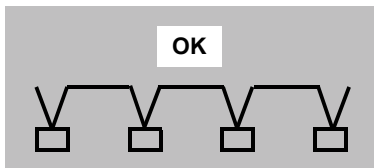

SHIELD

- It must be connected to a ground without disturbances
- Connected to round in only one point
- Provide to the shield continuity during all the serial cable extension.

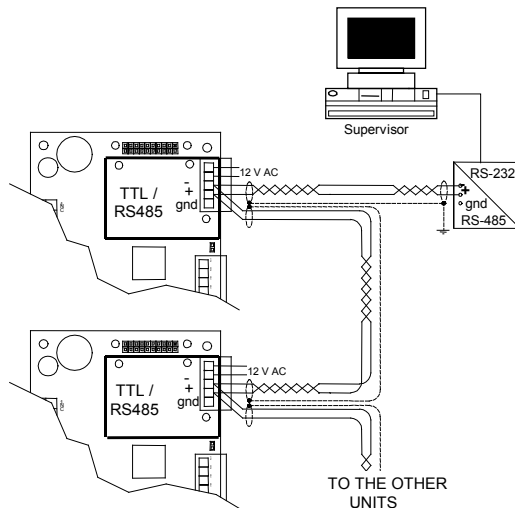
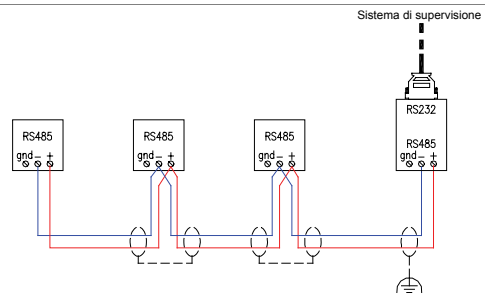

START-UP

ALL THE EQUIPMENT MUST BE COMMISSIONED BY AUTHORISED SERVICE CENTRES.
THIS SERVICE IS LIMITED TO START-UP OF THE UNIT ONLY AND NOT THE CONNECTIONS OR INSTALLATION OF THE SYSTEM.

ONLY QUALIFIED TECHNICIANS MUST PERFORM THE FOLLOWING OPERATIONS.

PRELIMINARY CHECKS

Before checking, please verify the following

1. the unit should be installed properly and in conformity with this manual.
2. the electrical power supply line should be sectioned at the beginning.
3. the sectioning device is locked and the proper warning "not to operate" sign is placed on the handle.
4. make sure no tension is present
5. the coils must be clean and free of obstacles
6. the ventilators must be free of leaves, cardboard, fixed obstacles (beams, barriers, etc.), snow, etc
7. the external ventilators must not be blocked

The external ventilators can be subject to a temporary block, especially if the inactivity period before the first start-up was quite long or if outside temperature is very low. It is also possible to unblock them manually (ONLY WHEN THE UNIT IS UNPLUGGED – RISK OF INJURES) so that jams or electric overloads are avoided when the unit is restarted.

REFRIGERANT SYSTEM

Carefully check the refrigerating circuit: the presence of oil stains can mean leakage caused by transportation, movements or other).

Open the cocks of the refrigerator circuit, if there are any.

Using the unit manometers, if present, or service manometers, verify that the refrigerating circuit is in pressure.

Make sure that all the service outlets are closed with proper caps; if caps are not present a leak of refrigerant can be possible.

WATER SYSTEM

Ensure that the plumbing system has been washed. Drain the wash water before connecting the unit to the system.

Check that the water circuit has been filled and pressurised. Perform a seal check at max. working pressure checking that no leaks are present.

Check that the shut-off valves in the circuit are in the "OPEN" position.

Check that there is no air in the circuit. If required, bleed it using the vent valves in the system.

Check that there are no ARIES EFFECTS in the transient (pump and / or valve activation/deactivation)

When using antifreeze solutions, make sure the glycol percentage is suitable for the type of use envisaged

% weight of ethylene glycol	10 %	20 %	30 %	40 %
Freezing point	- 4 °C	- 9 °C	- 15 °C	- 23 °C
Safety temperature	- 2 °C	- 7 °C	- 13 °C	- 21 °C

Check that the circulating pumps are not blocked. In fact, their motor shaft may seize up, especially after long shutdowns. Unblocking can be accomplished with a screwdriver using the purge hole.

ELECTRICAL SYSTEM

Check the proper tightening of the screws that fix the conductors to the electrical components in the board (during handling and transportation, the vibrations could have loosened them).

Verify that the unit is connected to the ground plant.

Control that all panels and protection devices of the unit are repositioned and blocked.

Charge the unit by closing the sectioning device, but leave it on OFF.

Make sure that the tension and net frequency values are within the limit of:

230 +/- 6% single phase unit; 400/3/50 +/- 6% three-phase unit

Control the unbalancing of the phases: it must be lower than 2% .

Example:

$L1 - L2 = 388 \text{ V}$, $L2 - L3 = 379 \text{ V}$, $L3 - L1 = 377 \text{ V}$
average of the measured values = $(388 + 379 + 377) / 3 = 381$

maximum deviation from the average = $388 - 381 = 7 \text{ V}$

Unbalancing = $(7/381) \times 100 = 1.83\% = \text{ACCEPTABLE}$

Operating out of the indicated limits causes the loss of the guarantee as well as very serious damages.

IF THE CRANKCASE HEATERS ARE FITTED

when the unit is started up for the first time and following all prolonged periods of inactivity is OBLIGATORY to connect the oil heaters on the compressor crankcase at least 8 hours before the compressor is to be started.

BEFORE POWERING THE HEATERS, OPEN THE COMPRESSORS COCKS, IF PRESENT.

To supply the heaters is necessary to switch off the isolator switch on the unit.

To make sure that the heaters are working, check the power input with amperometric pliers.

At start-up the compressor crankcase temperature on the lower side must be higher at least of 10°C than the outside temperature.

DO NOT START THE COMPRESSOR WITH THE CRANKCASE OIL BELOW OPERATING TEMPERATURE.

VERIFY TENSIONS – ABSORPTIONS

Check that the temperatures of the fluids are included in the WORKING LIMITS.

If the controls of the previous paragraphs are positive, it is possible to restart the unit.

For information on the control panel, refer to the paragraph CONTROL.

While the unit is working (ATTENTION ELECTRIC RISK: WORK SAFELY) check:

- Power supply tension
- Phase unbalance
- Total absorption of the unit
- Absorption of the single electric loads

UNIT EQUIPPED WITH SCROLL COMPRESSORS

The GENERAL TECHNICAL DATA table shows the type of compressor on the unit.

The Scroll compressors have only one direction of rotation.

In the event that the direction is reversed, the compressor will not be damaged, but its noisiness will increase and pumping will be negatively affected. After a few minutes, the compressor will stop because of the activation of the thermal protection. In this event, cut the power and reverse the 2 phases on the machine power.

Prevent the compressor from working with in reverse rotation: more than 2-3 anomalous starts up can damage it.

Make sure the direction of rotation is correct, measure the condensation and suction pressure. Pressure must clearly differ: at the start, the suction pressure decreases whilst the condensation pressure increases.

The phase optional monitor, which controls the phase sequence, can be installed later.

REMOTE INPUT CONFIGURATIONS

Check used remote inputs are activated (ON-OFF etc.) as given in the instructions in the ELECTRIC WIRING chapter.

SETTING THE SET-POINT

Check if it is necessary to modify the set-points shown in the CONTROL chapter

EVAPORATOR WATER FLOW RATE

Check that the difference between the temperature of exchanger return and supply water corresponds to power according to this formula:

$\text{unit cooling power (kW)} \times 860 = \text{Dt (}^\circ\text{C)} \times \text{flow rate (L/h)}$.

The cooling power is shown in the TABLE ON GENERAL TECHNICAL DATA included in this manual, referred to specific air/water conditions, or in the tables on cooling PERFORMANCE IN THE TECHNICAL BULLETIN referred to various conditions of use.

Check for water side exchanger pressure drops:

- Determine the water flow rate.
- Measure the difference in pressure between exchanger input and output and compare it with the graph on WATER SIDE EXCHANGER PRESSURE DROPS.

The measurement of pressure will be easier if pressure gauges are installed as indicated in the DIAGRAM OF SUGGESTED WATER CONNECTIONS .

REFRIGERANT CIRCUIT PARAMETER CHECK

Detecting the operational conditions is useful to control the unit along time: the performed records must be kept and be available during maintenance interventions.

When the unit works in stable conditions and according to the operating limits, take note of the following data:

1. compressor discharge temperature (WARNING – BURN DANGER!)
2. condensing pressure
3. liquid temperature
4. dehydrator filter upstream and downstream temperature
5. return pressure
6. return temperature
7. exchanger input water temperature
8. exchanger output water temperature
9. external air temperature (coil input)
10. air temperature coming out from fans

CONTROL

The HEATING mode functions are active only on HEAT PUMP unit version .
 In ONLY COOL units, the relative parameters are VISIBLE but NOT ACTIVE ,
 for example the winter setpoint.

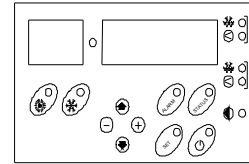

OPERING MODES

ON – OFF	Unit can be switched on and off by: remote or service keypad remote switch (see ELECTRICAL CONNECTIONS paragraph) Supervisor
COOLING	The compressor is activated with supply temperature higher than set point
ECO	A secondary set-point can be used, with respect to the comfort setting. In heating the ECO-set is lower than the standard set , in cooling the ECO-set is higher than the standard set.
MAINTENANCE	the plant can be kept within the operating limits even when the unit is OFF or on STANDBY

CHARACTERISTICS

THERMOREGULATION

The thermoregulation is based on the SUPPLY temperature.

The unit is dimensioned for a determined TOTAL HEAD between input and output water temperature.

Usually the project step is 5°C; if the value is different, it is necessary reset parameters 37 and 38 (accessible to the service centre). In function of the total head, the installation determines the head quote that every resource (compressor, heating elements) is able to provide: the STEP HEAD. The control logic insert gradually the resources when the supply temperature is higher than the set point + the head step.

The resources are activated one at a time and only at the SCAN TIME expiring. The scan time is not fixed but it changes in function of the margin between the water supply temperature and the Set point value. Higher is the margin value (both in positive and in negative) shorter will be the space among the scan points.

The scan time value is visualized at status 4; when the status 3 has reached the status 4 value, the compressor operating request is activated.

What above described, refer to the COOLING operating; in HEATING le logic is the same but “overturned” (insertion of the compressor for supply temperature < set-point –step jump)

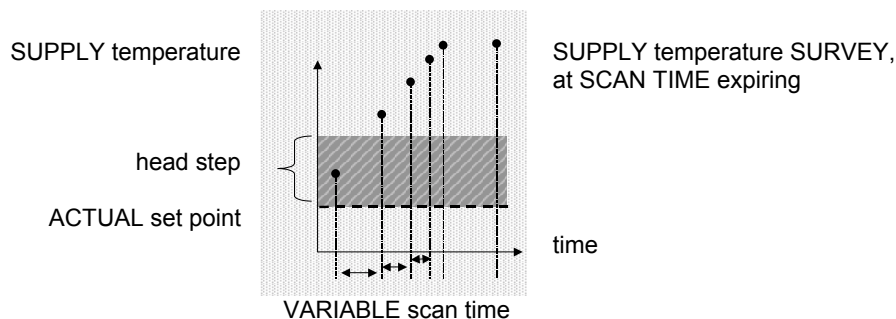

SET-POINT COMPENSATIONS

The compensations are evolved functions to protect the compressors and to adapt, as far as possible, the unit operating to the installation and use characteristics.

The compensations prolong the compressor operating time and limit the start number; to do this they delay the compressor insertion point adding an offset.

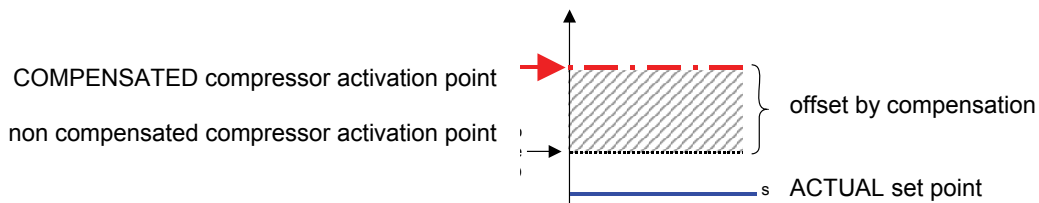

- The compensation on the DURATION is useful when the installation water content is limited.
- The compensation on the CHARGE is useful if the variable charge is present.

For the enabling and the configuration is necessary the parameter modification with reserved access to the service centres. In industrial applications where is requested a temperature check is possible to disable the COMPENSATIONS.

SET-POINT CORRECTIONS

The correction aim is to optimize the unit energetic efficiency.

To do this the corrections modify the set point in a dynamic way in function of determined variables: for example in summer operating with low outside temperatures, so with a reduced charge, is possible to obtain the internal comfort also with set point higher than standard, obtaining an higher energetic efficiency.



The static set point can so be modified in a dynamic way by two CORRECTIONS based on as many unit external factors:

- correction based on the ext. temp. / enthalpy
- correction based on the Water reset (4-20 mA signal provided by the Client)

The correct set point, to whom have been summed or removed the corrections, is named ACTUAL set-point and it is visible at status n°1.

The STATA menu visualizes the compensation value on the ext. temperature (status 5) and WR (status 6)

For further details see the ELECTRICAL CONNECTIONS section

DEFROSTING

The defrosting aim is to maintain the external coil free from ice during the winter mode : to do that the unit is periodically commuted in "summer" mode for few minutes and the fans are stopped.

The defrosting phase is started when the evaporating pressure falls below a fixed value . A count starts and at its end, if the temperature on the coil is lower than the threshold, the defrosting starts .

The count changes according to the outside temperature and to the ice quantity on the coil (by some indirect variables) .

When defrosting is complete, the unit returns automatically to the Winter mode.

Defrosting is managed according to the outside temperature and humidity in the air:

- more humidity = frequent defrosting
- outside temperature next to 0°C = frequent defrosting

By the EXTERNAL HUIDITY PROBE option cod PE2N0005 the defrosting is optimised according to the outside temperature and humidity .

CIRCULATION PUMP

The pump is always activated with the units ON.

The delivery capacity is variable to soften the thermal shock to the compressors when the plant temperature is close to the threshold limits.

Delivery capacity depends on the intake temperature:

- SUMMER: high water temperature reduces delivery

VENTILATION

Fans are controlled with a variable speed:

- in SUMMER, the speed increases according to the increase of external air temperature
- in WINTER the speed increases according to the decrease of the external tempe

SET POINT

SET-POINT CALCULATION:

- desired medium supply water temperature = 7°C
 - Project temperature differential = 5°C (that is return water = 12°C)
 - ¼ of the project temperature differential = $5 / 4 = 1.25^\circ\text{C}$
- set-point to be set = $7 - 1.25 = 5.7^\circ\text{C}$

SECONDARY SET POINT – ECO

A secondary set point can be used with different levels to the "normal" set point.

It is normally set to give lower energy consumption with respect to the comfort setting:

- The SECONDARY SUMMER set point is higher than the SUMMER setting.
- It can be set according to individual requirements.
- Secondary summer set-point parameter 29

It can be activated from the keyboard, supervisor unit or the remote control.

- To change it using the remote control refer to the ELECTRIC WIRING paragraph.

If the 3-way valve option for sanitary water is present, the 2° set point in heating can be activated by service/remote keypad with par 49 =1.

par	Description	Meaning	value
49	Comando2°Set	2° set point mode control by parameter	0

MAINTENANCE

This way, the plant can be kept within the operating limits even when the unit is OFF or on STANDBY, for example during the weekend or the nighttime. Periodically the system activates the circulation pump, measures the water temperature and activates the compressor, if required, to take the water temperature to the set-point level.

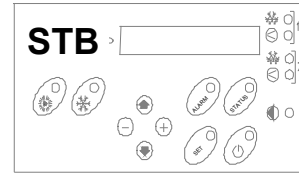

- Summer maintenance set-point par 42

This function is activated by parameters 44 (activate summer maintenance level) and 45 (activate winter maintenance level). With unit in maintenance mode, the display visualizes **STB**.

FUNCTIONING WITH ETHYLENE GLYCOL

The units foreseen to function with glycoled water come out from the premise with standard parameters. After having added glycol ethylene to water, the technician will properly set the plant.

Parameter to modify:	32	Summer set point
	77	Antifreeze resistanceset
	80	Antifreeze alarm
	84	Antifreeze pre-alarm threshold

KEYPAD

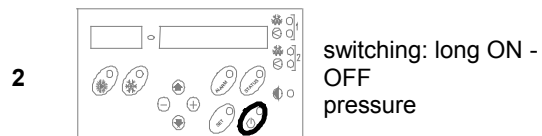
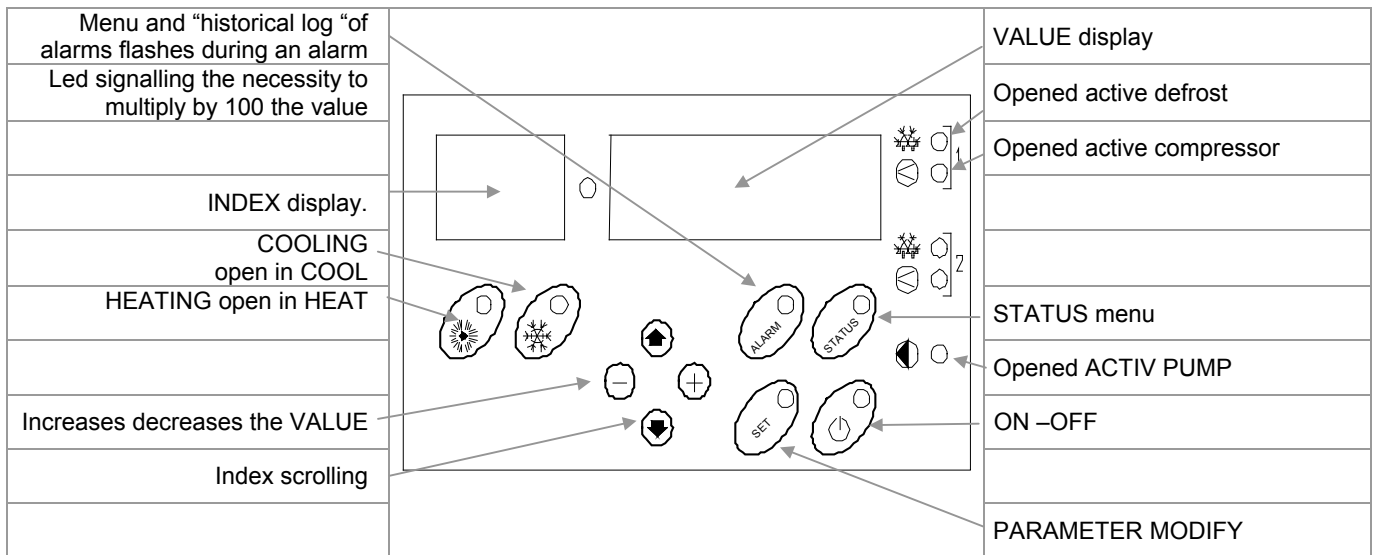

ACCESSIBLE PARAMETERS FROM REMOTE OR SERVICE KEYBOARD

num. Par.	description	Value	UM
29	Summer secondary Set Point	10	°C
32	Summer Set Point	5.7	°C
42	Summer Set Point Maintenance	20	°C
44	Enables Summer Maintenance	0	num
77	Antifreeze resistanceset point	4	°C
80	Antifreeze alarm	4	°C
84	Limit of deactivation before reaching the antifreeze steps	4.5	°C
163	Configures remote inputs: 1 = H/C by keypad or supervisor		
192	Keypad address		

PARAMETER MODIFICATION

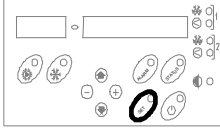
1  Push SET button

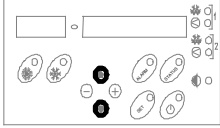
2  Select the parameter

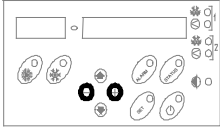
3  Modify the value

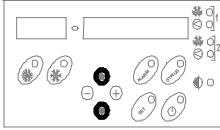
4  Select another parameter

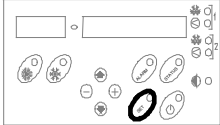
5  SET to esc

VISIBLE STATUS FROM REMOTE KEYBOARD OR SERVICE KEYBOARD

Visible status from remote keyboard or service keyboard		
INDEX	DESCRIPTION	VALUE
1	Current Set Point	°C
2	Temperature drop in degrees centigrade given by the compressor including compensations, if any	°C
3	Resource activation timer When this value reaches the value fixed at the 4 status, the thermal regulator will compare the input temperature with the set point and will activate the resources, if necessary	Seconds
4	Dynamic TimeScan relating to source activation	Seconds
5	Value in degrees of the external air compensation	°C
6	Value in degrees of the water reset signal compensation	°C
7	Value in degrees of the charge compensation	°C
9	Return temperature	°C
10	Supply temperature 1	°C
11	Supply temperature 2	°C
12	Coil temperature 1	°C
13	Condensing pressure 1	Bar
14	Fan/Coil percentage 1	0-100%
15	Coil temperature 2	°C
16	Condensing pressure 2	Bar
17	Condensing pressure 2	Bar
18	Water Reset signal value	4-20 mA
19	Outdoor temperature	°C

Visible status from remote keyboard or service keyboard

INDEX	DESCRIPTION	VALUE
20	Outdoor Humidity	0-100%
21	Machine Clock - fed unit hours	Num
22	Working hours C1	Num
23	Pickups C1	Num
24	Working hours C2	Num
25	Pickups C2	Num
30	Keypad software	AS – t
31	Year of certification of the keyboard SW	2007
32	Month of certification of the keyboard SW	03
33	Day of certification of the keyboard SW	04
34	Base Software	AS – b
35	Year of certification of the keyboard SW	2007
36	Month of certification of the keyboard SW	1
37	Day of certification of the keyboard SW	11

STATUS DISPLAY

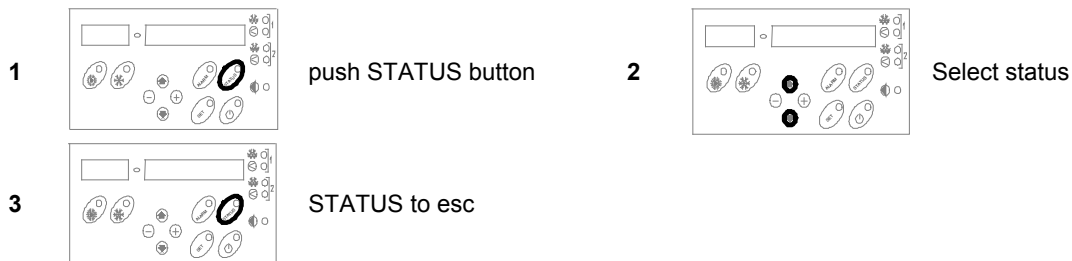

ALARMS

BEFORE RESETTING THE ALARM, IDENTIFY AND ELIMINATE THE CAUSE OF ITS ACTIVATION. REPEATED RESETS CAN CAUSE IRREVERSIBLE DAMAGES.

The **ALARMS** show a potentially dangerous situation for machine safety.

Before resetting the alarm, discover and remove the cause: repeated resetting could cause irreversible damage. To avoid this, the unit can only be reset **MANUALLY** from the keyboard (only when the cause for the alarm has been removed).

PRE-ALARMS and **SIGNALS** warn of a risky situation. These could be acceptable only if they happen occasionally or in transitory situations (for example when the plant is being started up).

They are reset **AUTOMATICALLY**, as soon as the cause has been removed, without any input from the keyboard.

The pre-alarms are signalled by the fixed C code (not flashing) and on the right the control temperature.

The **FAULTS** warn of problems with the probes and transducers, and are reset **AUTOMATICALLY** to allow the unit to continue running, perhaps with fewer functions.



In case of doubt, always contact an authorised service centre.

The presence of an alarm is signalled by the **ALARM CODE** flashing and the time at which the alarm/alarms occurred.

The cumulative block relay activates simultaneously to the alarm code visualization.

Certain alarms, in particular **PRE-ALARMS**, do not activate the relays.

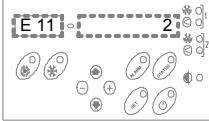
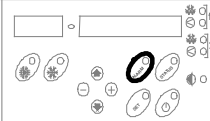
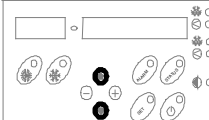
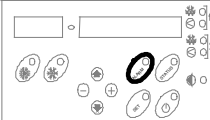
ALARM VISUALIZATION

- 1  flashing
Alarm code
Alarm unit hours
- 2  opened alarm log
short pressure
ALARM
- 3  The most recent alarm is
visualized
Use the arrow keys to
visualize other alarms
- 4  To esc
Short pressure
ALARM
- 5  To RESET
LONG pressure
ALARM

According to the unit configuration and to the current options, some status can not be used.

INDEX	ALARM	RESET	
E	1	Faulty or disconnected water return probe	Auto.
E	2	Faulty or disconnected water supply probe 1	Auto.
E	3	Faulty or disconnected water supply probe 2	Auto.
E	4	Faulty or disconnected coil probe 1	Auto.
E	5	Faulty or disconnected coil probe 2	Auto.
E	6	Faulty or disconnected external probe	Auto.
E	7	Faulty or disconnected pressure transducer 1	Auto.
E	8	Faulty or disconnected pressure transducer 2	Auto.
S	9	Water Reset return in short circuit or out of range	Auto.
E	10	Faulty or disconnected external RH% probe	Auto.
E	11	High pressure 1	MANUAL
E	12	Low pressure 1	Auto.
E	13	Condensing fan and/or compressor thermal 1 switch	MANUAL
E	14	High pressure 2	MANUAL
E	15	Low pressure 2	Auto.
E	16	Condensing fan and/or compressor thermal 2 switch	MANUAL
E	17	Pump flow	Auto.
E	18	System charged with water	MANUAL
E	19	Phase monitor	Auto.
E	20	Antifreeze alarm	MANUAL
S	21	Antifreeze PREAlarm	Auto.
S	22	High pressure PreAlarm 1	Auto.
S	23	High pressure PreAlarm 2	Auto.
S	24	Pump change	Auto.
E	25	C1 flow alarm	Auto.
E	26	C2 flow alarm	Auto.
E	27	C1 low temperarue alarm	Auto.
E	28	C2 low temperarue alarm	Auto.
E	33	Condenser frost alarm	MANUAL
E	34	Evaporator input temp. alarm	Auto.
E	35	Incongruent DeltaT alarm	MANUAL
S/E	36	BP1 Low pressure pre-alarm C1	Auto.
S/E	37	BP1 Low pressure pre-alarm C2	Auto.

S = anomalous situation signalisation that doesn't compromise the unit functionality

E = ALARM, situation that compromises the unit functionality

ROUTINE MAINTENANCE

BEFORE UNDERTAKING ANY SORT OF MAINTENANCE OR CLEANING, DISCONNECT THE ELECTRICAL POWER SUPPLY TO THE UNIT, AND ENSURE THAT OTHER PEOPLE CANNOT RE-CONNECT IT .

All equipment is subjected to wear out.

The maintenance makes :

1. keeps the unit efficiency
2. the components last longer
3. keeps their efficiency and limits breakdowns

Therefore, it is fundamental to perform periodical checks: a few controls can be performed by the user (AUTONOMOUS MAINTENANCE) and they are mainly

cleaning activities; otherwise, controls have to be performed by specialized technicians (INSPECTIONS).

The machine should have a log book used to keep track of the performed controls. This will make fixing up breakdowns easier.

Take note of the date, type of control (autonomous maintenance, inspection or fixing up), description of the control, actions taken and so on.

SERVICES

Parts subject to intervention:

- EXTERNAL AIR COIL
- WATER EXCHANGER
- STRUCTURE
- ELECTRIC FANS

EXTERNAL AIR COIL

ATTENTION: contact with the exchanger fins can cause cuts. Wear protective gloves to perform the above described operations.

It is extremely important that the battery gives the maximum thermal exchange; therefore, its surface must be cleaned from dust and deposits. Remove all impurities from the surface.

Using an air pressure gun, clean the aluminum surface of the battery. Be careful to direct the air in the opposite

direction of the fan air movement. Hold the gun parallel to the fins to avoid damages. As an alternative, an aspirator can be used to suck impurities from the air input side.

Verify that the aluminum fins are not bent or damaged. In the event of damages, contact the authorized assistance center and get the battery "ironed out" in order to restore the initial condition for an optimal air flow.

WATER EXCHANGER

It is very important for the exchanger to be able to provide the maximum thermal exchange. Therefore, it is essential for the inner surfaces to be clean of dirt and incrustations.

Periodically check the difference between the temperature of the supply water and the condensation temperature. If the difference is greater than 8 °C – 10 °C it is advisable to clean the exchanger.

STRUCTURE

Check the condition of the parts making up the structure. Paint so as to eliminate or reduce oxidation at the points in the unit where this problem may occur. Check that the

panelling is fastened correctly. Poor fastening may give rise to malfunctions and abnormal noise and vibration.

ELECTRIC FANS

Make sure that the fans and the relative protection grids are well fixed.

Check, if possible, the unbalances of the electro-fan evident by noise and anomalous vibrations. Verify that the terminal protection covers are closed and the cable holders are properly positioned.

MAINTENANCE INSPECTIONS

Foresee inspection assistance carried out by authorized centers or by qualified personnel.

The inspections should be carried out at least:

- - Every year for only the cooling units
- - Every six months for the cooling and warming units

The frequency, however, depends on the use: in the event of frequent use (continuous or very intermittent use, near the operating limits, etc) or critical use (service necessary) it is recommended to plan inspections at close intervals.

The inspections to be performed are as follows:

- verify the power supply tension (when emptied or filled)
- inspect the electrical board (status of solenoid starter contacts, terminal closings, the status of wiring and relevant insulations)
- inspect the absorption of the single electrical loads
- verify the cleaning and the efficiency of the exchangers
- inspect the cleaning of the filters (air/water)

- verify the leakage from the refrigerating circuit
- Verify the protection devices (safety valves, pressure switches, thermostats, etc.), the adjustment systems, the control devices (alarm signalizations, probes, manometers, etc)
- check the operating parameters of the refrigerating circuit (see the following REFRIGERANT TABLES and the START-UP section)

For units equipped with safety valves, follow the Manufacturer's instructions.

Verify periodically the cleaning of the safety valves and that oxidative / corrosive phenomena are not present, in particular for installations near the sea, in industrial areas or in rooms with a corrosive atmosphere.

97/23 CE PED DIRECTIVE

97/23 CE PED DIRECTIVE gives instructions for installers, users and maintenance technicians as well. Refer to local actuation norms.

In Italy, refer to the Ministerial Decree of 1st December 2004 no. 329 (and following modifications) which defines the performances to be executed; the units of 1st category and those defined by the art. 3.3 97/23/EC are not included in this regulation (see the serial number plate on the unit) .

Briefly and as an example, see the following :

1. COMPULSORY VERIFICATION OF THE FIRST INSTALLATION only for units assembled on the installer's building site (for ex. Condensing circuit + direct expansion unit)
2. CERTIFICATION OF SETTING IN SERVICE for all the units
3. PERIODICAL VERIFICATIONS to be executed with the frequency indicated by the Manufacturer (see the MAINTENANCE INSPECTIONS paragraph)

PUT AT REST

If a long period of inactivity is foreseen, for example the winter for the cooling unit, the following is recommended:

- to turn the power off in order to avoid electrical risks or damages by lightning strike
- to avoid the risk of frosts as shown in the HYDRAULIC CONNECTIONS section, and, in particular
 - to empty or add glycole in the plant sections subjected to temperatures below zero
 - to empty or add glycole in the water heating coils, also in summer
 - to power antifreeze heaters if present

If the period of inactivity is particularly long or in the event of extremely low temperatures, the external fans can be blocked temporarily; therefore, it is recommended to switch them on every month in order to avoid seizures or electrical overloads when the unit will be switched on.

The restarting of the unit has to be carried out by qualified personnel, in particular, after the winter break for cooling units or when seasonal switching should be performed.

When restarting, refer to the SWITCHING ON section.

Schedule technical assistance in advance to avoid hitches and be able to use the installation when necessary.

REFRIGERANT TABLES

THIS SECTION IS DEVOTED ONLY TO QUALIFIED TECHNICIANS THAT KNOW THE FOLLOWING:

- THE OPERATIONAL PRINCIPLES OF THE REFRIGERATING CIRCUIT OPERATION
- THE MODES OF DETECTING TEMPERATURE AND PRESSURE
- THE RISKS RELEVANT TO THESE OPERATIONS

The data of the tables allow the testing of the refrigerating circuit operation by the detection of a few objective parameters.

The data are significant if they are detected simultaneously and while the refrigerating circuit is running.

The following examples are indicative, the values considerably change according to the type of unit and the working conditions.

- Liquid temperature
- Return pressure
- Return temperature
- Condensing pressure

OVERHEATING = return temperature – Saturation temperature

Return pressure 7.2 bar

Return temperature 7.3 °C

overheating $7.3 - 0.8 = 6.5$ °C

SUBCOOLING = condensing temperature (pressure *) – liquid temperature

Condensing pressure 29.6 bar

Liquid temp. 45 °C

subcooling $49.91 - 45 = 4.91$ °C

* It is important that the condensation pressure is detected as close as possible to the point where the liquid temperature is detected, in the event that the calculation will be effected by the losses of charge (and, therefore, of temperature) caused by the refrigerating circuit components placed between the two measurement points.

For R410A the glide was not considered, since it is close to 0.

The values in the tables refer to a specific refrigerant supplier; slight differences are possible with other suppliers.

Pg = P gauge = relevant pressure (read on the pressure gauge)

Ts : saturation pressure

Td = dew point temperature

Tb = bubble point temperature

Pg	R410A	Pg	R410A	Pg	R410A	Pg	R410A
	Ts [°C]		Ts [°C]		Ts [°C]		Ts [°C]
0.0	-51.66	11.0	13.40	22.0	37.88	33.0	54.54
0.2	-48.02	11.2	13.97	22.2	38.23	33.2	54.80
0.4	-44.83	11.4	14.54	22.4	38.58	33.4	55.06
0.6	-41.98	11.6	15.10	22.6	38.93	33.6	55.32
0.8	-39.40	11.8	15.66	22.8	39.28	33.8	55.58
1.0	-37.03	12.0	16.20	23.0	39.62	34.0	55.84
1.2	-34.84	12.2	16.74	23.2	39.96	34.2	56.09
1.4	-32.81	12.4	17.28	23.4	40.30	34.4	56.34
1.6	-30.90	12.6	17.81	23.6	40.64	34.6	56.60
1.8	-29.10	12.8	18.33	23.8	40.98	34.8	56.85
2.0	-27.39	13.0	18.85	24.0	41.31	35.0	57.10
2.2	-25.78	13.2	19.36	24.2	41.64	35.2	57.35
2.4	-24.24	13.4	19.87	24.4	41.97	35.4	57.60
2.6	-22.76	13.6	20.37	24.6	42.30	35.6	57.85
2.8	-21.35	13.8	20.86	24.8	42.62	35.8	58.09
3.0	-20.00	14.0	21.36	25.0	42.95	36.0	58.34
3.2	-18.69	14.2	21.84	25.2	43.27	36.2	58.58
3.4	-17.44	14.4	22.32	25.4	43.59	36.4	58.82
3.6	-16.22	14.6	22.80	25.6	43.90	36.6	59.07
3.8	-15.05	14.8	23.27	25.8	44.22	36.8	59.31
4.0	-13.91	15.0	23.74	26.0	44.53	37.0	59.55
4.2	-12.81	15.2	24.20	26.2	44.85	37.2	59.78
4.4	-11.74	15.4	24.66	26.4	45.16	37.4	60.02
4.6	-10.69	15.6	25.12	26.6	45.47	37.6	60.26
4.8	-9.68	15.8	25.57	26.8	45.77	37.8	60.50
5.0	-8.69	16.0	26.01	27.0	46.08	38.0	60.73
5.2	-7.73	16.2	26.46	27.2	46.38	38.2	60.96
5.4	-6.79	16.4	26.90	27.4	46.69	38.4	61.20
5.6	-5.87	16.6	27.33	27.6	46.99	38.6	61.43
5.8	-4.97	16.8	27.76	27.8	47.28	38.8	61.66
6.0	-4.10	17.0	28.19	28.0	47.58	39.0	61.89
6.2	-3.24	17.2	28.62	28.2	47.88	39.2	62.12
6.4	-2.40	17.4	29.04	28.4	48.17	39.4	62.35
6.6	-1.57	17.6	29.45	28.6	48.46	39.6	62.57
6.8	-0.77	17.8	29.87	28.8	48.76	39.8	62.80
7.0	0.02	18.0	30.28	29.0	49.05	40.0	63.02
7.2	0.80	18.2	30.69	29.2	49.33	40.2	63.25
7.4	1.56	18.4	31.09	29.4	49.62	40.4	63.47
7.6	2.31	18.6	31.49	29.6	49.91	40.6	63.69
7.8	3.05	18.8	31.89	29.8	50.19	40.8	63.92
8.0	3.77	19.0	32.28	30.0	50.47	41.0	64.14
8.2	4.48	19.2	32.68	30.2	50.75	41.2	64.36
8.4	5.18	19.4	33.07	30.4	51.03	41.4	64.58
8.6	5.87	19.6	33.45	30.6	51.31	41.6	64.79
8.8	6.55	19.8	33.84	30.8	51.59	41.8	65.01
9.0	7.22	20.0	34.22	31.0	51.86	42.0	65.22
9.2	7.88	20.2	34.59	31.2	52.14	42.2	65.44
9.4	8.53	20.4	34.97	31.4	52.41	42.4	65.65
9.6	9.16	20.6	35.34	31.6	52.68	42.6	65.87
9.8	9.79	20.8	35.71	31.8	52.95	42.8	66.08
10.0	10.42	21.0	36.08	32.0	53.22	43.0	66.29
10.2	11.03	21.2	36.44	32.2	53.49	43.2	66.50
10.4	11.63	21.4	36.81	32.4	53.75	43.4	66.71
10.6	12.23	21.6	37.17	32.6	54.02	43.6	66.92
10.8	12.82	21.8	37.52	32.8	54.28	43.8	67.13

TROUBLESHOOTING

THE OPERATIONS MUST BE CARRIED OUT BY TECHNICAL QUALIFIED PERSONNEL HAVING THE REQUISITES UNDER LAW REQUISITES AND IN CONFORMITY WITH THE SAFETY REGULATIONS IN FORCE.

THE INTERVENTIONS WITHIN THE WARRANTY PERIOD WILL BE CARRIED OUT BY AUTHORIZED SERVICE CENTERS.

**BEFORE RESETTING AN ALARM, IDENTIFY AND ELIMINATE ITS CAUSE.
REPEATED RESETS MAY CAUSE SERIOUS DAMAGES.**

In certain machine configurations, some safeties may be placed in series and lead back to a single input on the electronic module.

Therefore, check on the electrical diagram whether the device to which the alarm corresponds has other devices or safeties connected in series.

Below is a list of the possible causes of alarms.

HIGH PRESSURE (in cooling)

1. high water temperature (see operating limits)
2. high air temperature (see operating limits)
3. coil dirty / clogged
4. fans don't work / low speed
5. Manostat/transducer: loose electric contacts/terminals, wiring cables interrupted
6. Anti-condensation gas in the cooling circuit
7. Too much refrigerant
8. Check the trigger point for the manostat and transducer
9. Check the manostat or transducer pressure control point (deposits of oil, dirt, pin blocked mechanically)

LOW PRESSURE (in cooling)

1. low air temperature (see operating limits)
2. low water temperature (see operating limits)
3. insufficient water flow to the exchanger (high thermal difference between input and output)
4. not CONSTANT flow (for example, if the pumps are turned off, certain areas of the plant are excluded or included, other uses are isolated, etc)
5. Water filter clean / valves open /air bubbles in the plant
6. dirty exchanger
7. Manostat/transducer: loose electric contacts/terminals, wiring cables interrupted
8. refrigerant circuit empty, visible leaks of refrigerant/oil, insufficient charge
9. Blocked dehydrator filter
10. thermostatic device not operating correctly
11. Check the trigger point for the manostat and transducer
12. Check the manostat or transducer pressure control point (deposits of oil, dirt, pin blocked mechanically)

FAULTY PROBE

1. Identify the part on the wiring diagram.
2. Loose electric contacts/terminals, leads broken
3. Check the correct probe ohmic level (using a tester)
4. Change the probe.
5. Check the electronic module configuration (only an authorised service centre can do this)
6. Change the electronic module

FAULTY PRESSURE TRANSDUCER

1. Identify the part on the wiring diagram
2. Loose electric contacts/terminals, leads broken
3. Check the pressure test points are in working order
4. Change the part
5. Check the electronic module configuration (only an authorised service centre can do this)
6. Change the electronic module

COMPRESSOR PROTECTION

1. Identify the part on the wiring diagram
2. Loose electric contacts/terminals, leads broken
3. electrical windings interrupted
4. Vacuum power voltage below the limits
5. power contactors / contacts defective
6. start-up power voltage lower than the limits
7. electrical absorption high / unbalanced
8. High compressor discharge temperature > thermostatic device needs calibrating, insufficient refrigerant charge

FAN PROTECTION

1. Identify the part on the wiring diagram
2. fan mechanically jammed, bearings / drive belt (if present)
3. Loose electric contacts/terminals, leads broken
4. electrical windings of fan interrupted
5. power supply voltage below limits
6. electrical absorption high / unbalanced

PUMP PROTECTION

1. Identify the part on the wiring diagram
2. pump jammed (probable for circulating pump after lengthy seasonal shutdowns)
3. Loose electric contacts/terminals, leads broken
4. electrical windings of fan interrupted
5. power supply voltage below limits
6. electrical absorption high / unbalanced

CONVERSION TABLE FOR RESISTANCETEMPERATURE FOR TEMPERATURE PROBES NTC

To check the reliability of the probes in the event of alarm signals, the table below shows the relationship between the temperature and the resistancevalue in Ohms.

Temperature °C	Heater Ω	Temperature °C	Heater Ω	Temperature °C	Heater Ω	Temperature °C	Heater Ω
-20,0	67732	1,0	26094	22,5	11013	43,5	5146
-19,5	66149	1,5	25543	23,0	10805	44,0	5063
-19,0	64604	2,0	25005	23,5	10601	44,5	4981
-18,5	63097	2,5	24480	24,0	10401	45,0	4901
-18,0	61627	3,0	23969	24,5	10206	45,5	4823
-17,5	60193	3,5	23469	25,0	10014	46,0	4747
-17,0	58794	4,0	22982	25,5	9826	46,5	4672
-16,5	57429	4,5	22506	26,0	9643	47,0	4599
-16,0	56098	5,0	22042	26,5	9462	47,5	4527
-15,5	54800	5,5	21589	27,0	9286	48,0	4458
-15,0	53534	6,0	21146	27,5	9113	48,5	4389
-14,5	52300	6,5	20714	28,0	8944	49,0	4322
-14,0	51096	7,0	20292	28,5	8778	49,5	4256
-13,5	49921	7,5	19880	29,0	8615	50,0	4192
-13,0	48777	8,5	19085	29,5	8456	50,5	4128
-12,5	47660	9,0	18701	30,0	8300	51,0	4066
-12,0	46571	9,5	18326	30,5	8147	51,5	4005
-11,5	45510	10,0	17960	31,0	7998	52,0	3944
-11,0	44475	10,5	17602	31,5	7852	52,5	3885
-10,5	43466	11,0	17252	32,0	7708	53,0	3826
-10,0	42482	11,5	16910	32,5	7568	53,5	3767
-9,5	41523	12,0	16576	33,0	7430	54,0	3710
-9,0	40588	12,5	16249	33,5	7296	54,5	3652
-8,5	39676	13,0	15930	34,0	7164	55,0	3595
-8,0	38787	13,5	15617	34,5	7035	55,5	3538
-7,5	37920	14,0	15312	35,0	6909	56,0	3482
-7,0	37075	14,5	15013	35,5	6786	56,5	3425
-6,5	36252	15,0	14720	36,0	6665	57,0	3368
-6,0	35448	15,5	14434	36,5	6547	57,5	3310
-5,5	34665	16,0	14155	37,0	6431	58,0	3252
-5,0	33902	16,5	13881	37,5	6318	58,5	3194
-4,5	33157	17,0	13613	38,0	6208	59,0	3135
-4,0	32431	17,5	13351	38,5	6100	59,5	3075
-3,5	31724	18,0	13094	39,0	5994	60,0	3014
-3,0	31034	18,5	12843	39,5	5891	60,5	2951
-2,5	30361	19,0	12597	40,0	5790	61,0	2888
-2,0	29704	19,5	12356	40,5	5692	61,5	2822
-1,5	29064	20,0	12120	41,0	5596	62,0	2755
-1,0	28440	20,5	11890	41,5	5502	62,5	2686
-0,5	27831	21,0	11663	42,0	5410	63,0	2615
0,0	27238	21,5	11442	42,5	5320	63,5	2542
0,5	26659	22,0	11225	43,0	5232	64,0	2466

DECOMMISSIONING OF THE UNIT

DISCONNECTING THE UNIT

The units must be disconnected by authorised personnel, who before proceeding must first read the Residual Risks section in this manual.

Before disconnecting the unit, the following must be recovered, if present:

- the refrigerant (if the circuits cannot be isolated): the refrigerant must be removed using suction devices operating in a closed circuit, so as to ensure that none of the compound is released into the atmosphere.
- the antifreeze in the circuits: when removing this fluid, make sure that it does not leak and that it is not released into the environment. The antifreeze fluid must be stored in special containers.

When recovering the substances present in the unit, all measures must be taken to avoid damaging persons and things and polluting the surrounding area.

Awaiting dismantling and disposal, the unit can also be stored outdoors, as bad weather and rapid changes in temperature will not cause damage to the environment, if electric, cooling and hydraulic circuits of the unit are integral and closed.

DISMANTLING AND DISPOSAL

THE UNIT MUST ALWAYS BE SENT TO AUTHORISED CENTRES FOR DISMANTLING AND DISPOSAL.

When dismantling the unit, the fan, the motor and the coil, if operating, may be recovered by the specialist centres for reuse.

All the materials must be recovered or disposed of in compliance with the corresponding national standards in force.

For further information on the decommissioning of the unit, contact the manufacturer.

TECHNICAL DATA

SIZE			82	102	122	162	182	222	262	302
Cooling										
Cooling capacity	1	kW	24,3	28,2	33,7	40	45,9	54,4	64,1	72,2
Comp. input power	1	kW	8,5	10	12,1	13,5	16	19,2	22,3	25,5
Total input power	2	kW	8,9	10,4	12,5	14,2	16,7	19,9	23,4	26,6
EER	1		2,73	2,72	2,71	2,81	2,74	2,73	2,74	2,71
ESEER			4,32	4,48	4,18	4,20	4,34	4,47	4,19	4,06
COMPRESSORS										
Compressor type	3		SCROLL							
No. of compressors		Nr	2							
Capacity control steps Std		Nr	3	3	2	3	3	3	3	2
Refrigerant circuits		Nr	1							
Refrigerant charge (C1)		l	3,61	3,72	3,54	5,76	5,76	6,65	7,39	8,28
INTERNAL EXCHANGER										
Type of exchanger	4		PHE							
No. Of exchangers		Nr	1							
Water flow-rate	1	l/s	1.2	1.3	1.6	1.9	2.2	2.6	3.1	3.4
Pressure drop		kPa	48	47	41	43	43	38	40	42
Useful pump discharge head	1	kPa	132	126	120	104	88	148	139	131
EXTERNAL SECTION FANS										
Fan type	5		AX							
No. of fans		Nr	2	2	2	4	4	4	6	6
Standard air-flow	1	l/s	2545	2538	2514	4933	4875	4778	7196	7145
Installed unit power		kW	0,17	0,17	0,17	0,18	0,18	0,18	0,18	0,18
CONNECTIONS										
Water fittings			1" 1/4				2"			
HYDRAULIC CIRCUIT										
Max water side pressure		kPa	550							
Safety valve calibration		kPa	600							
EXPANSION VESSEL										
Expansion vessel capacity		l	5							
Maximum water side pressure			550							
No. of expansion vessels		Nr	1							
POWER SUPPLY										
Standard power supply		V	400/3/50+N							
NOISE LEVELS										
Sound pressure level (1 m)		dB(A)	60	60	60	61	62	62	64	64
DIMENSIONS										
Length		mm	1703	1703	1703	1932	1932	1932	2332	2332
Depth		mm	675	675	675	1100	1100	1100	1100	1100
Height		mm	1209	1209	1209	1417	1417	1417	1417	1417
Packing volume		m ³	1,8	1,8	1,8	4	4	4	4,5	4,5
STANDARD UNIT WEIGHTS										
Shipping weight		kg	315	320	370	530	550	580	675	690
Operating weight		kg	305	310	360	520	540	570	665	680

(1) data referred to the following conditions :

internal exchanger water = 12/7°C
external exchanger air intake 35°C

(2) Total absorbed power is given by the compressor absorbed power
+ fan absorbed power + auxiliary circuit absorbed power.

(3) SCROLL = scroll compressor

(4) PHE = plates

(5) AX = axial-flow fan

SETTING THE CUT-OUT DEVICES AND CONTROLS

		On	Off		
High pressure switch	(kPa)	4200	3300		
Low pressure switch	(kPa)	200	350	Max compressor starts per hour	(n°) 10
Antifreeze protection	(°C)	4	6,5	Safety discharge thermostat	(°C) 120

FOULING CORRECTION FACTOR

m ² °C/W	INTERNAL EXCHANGER	
	F1	FK1
0.44 x 10 ⁻⁴	1,00	1,00
0.88 x 10 ⁻⁴	0,97	0,99
1.76 x 10 ⁻⁴	0,94	0,98

The cooling performance values provided in the tables are based on the external exchanger having clean plates (fouling factor 1). For different fouling factor values, multiply the performance by the coefficients shown in the table.

F1 = Cooling capacity correction factors

FK1 = Compressors input power correction factors

OPERATING LIMITS (COOLING)

SIZE		82	102	122	162	182	222	262	302
EXTERNAL EXCHANGER									
Max air intake temperature	1 °C	48	48,5	47	48,5	49	48,5	48,5	47,5
Max air intake temperature	2 °C	50	50,5	49	50,5	51	50,5	50,5	49,5
Min air intake temperature	3 °C	-10							
INTERNAL EXCHANGER									
Max air intake temperature	4 °C	23							
Min. water supply temperature	5 °C	5							
Min. water supply temperature	6 °C	-8							

Warning: the still air condition is meant as absence of air flow to the unit. Any wind condition can let air pass through the condenser coil thus worsening the operating limits of the unit (see limits with air speed at 0,5 m/s & 1 m/s).

ATTENTION: IN CASE OF PREDOMINANT WINDS, WINDBREAK BARRIERS ARE NECESSARY.

Water thermal head (min / max) are indicated in the section INTERNAL EXCHANGER PRESSURE DROP

- (1) unit at full load: internal exchanger water 12/7°C
 (2) internal exchanger water = 12/7°C

- capacity-controlled unit (automatic capacity control)
 (3) external exchanger air in quiet
 (4) this limit can be exceeded for brief and transitory periods with automatic capacity control of the unit: the maximum limit is 30°C.
 capacity-controlled unit (automatic capacity control)
 (5) standard unit
 outside air temperature 35°C
 (6) B = Low Temperature
 outside air temperature 35°C
 Fluid with ethylene glycol of 40%

SOUND LEVELS

Size	Sound Power Level (dB)								Sound pressure level dB(A)	Sound power level dB(A)
	Octave band (Hz)									
	63	125	250	500	1000	2000	4000	8000		
82	80	75	78	73	70	66	58	52	60	75
102	79	74	77	73	70	66	60	51	60	75
122	79	74	77	72	70	67	61	52	60	75
162	86	79	75	77	74	66	61	56	61	78
182	86	79	74	76	74	68	63	57	62	78
222	86	79	77	78	74	69	61	56	62	79
262	88	81	78	79	77	72	66	58	64	81
302	88	81	79	80	75	72	63	56	64	81

Notes:

Measures according to ISO 3744 regulations, with respect to the EUROVENT 8/1 certification.
 the sound levels refer to the unit at full load, in the rated test conditions.
 The sound pressure level refers to a distance of 1m from the external surface of the units operating in an open field.
 data referred to the following conditions :
 internal exchanger water = 12/7°C

INTERNAL EXCHANGER PRESSURE DROP

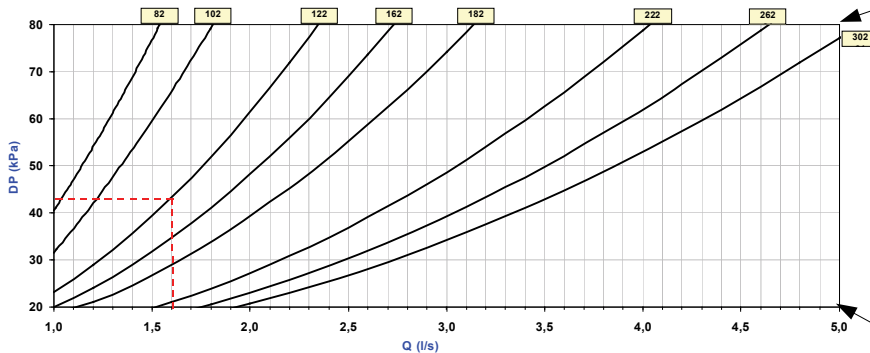

EXCHANGER PRESSURE DROP LIMIT. WAR-NING: DON'T USE OVER THIS LIMIT

UNIT WITHOUT HYDRAULIC CIRCUIT COMPONENTS
 DP = PRESSURE DROP
 Q = WATER FLOW

EXCHANGER PRESSURE DROP LIMIT. WARNING: DON'T USE BELOW THIS LIMIT

SIZE		82	102	122	162	182	222	262	302
Minimum flow	[l/s]	0,70	0,80	0,85	1,00	1,11	1,51	1,74	1,95
Maximum flow	[l/s]	1,52	1,80	2,85	2,71	3,05	4,05	4,65	5,00

CORRECTION FACTOR FOR ANTIFREEZE SOLUTIONS

% ethylene glycol by weight		5%	10%	15%	20%	25%	30%	35%	40%
Freezing temperature	°C	-2,0	-3,9	-6,5	-8,9	-11,8	-15,6	-19,0	-23,4
Safety temperature	°C	3,0	1,0	-1,0	-4,0	-6,0	-10,0	-14,0	-19,0
Cooling Capacity Factor	Nr	0,995	0,990	0,985	0,981	0,977	0,974	0,971	0,968
Compressor input Factor	Nr	0,997	0,993	0,990	0,988	0,986	0,984	0,982	0,981
Internal exchanger Glycol solution flow Factor	Nr	1,003	1,010	1,020	1,033	1,050	1,072	1,095	1,124
Pressure drop Factor	Nr	1,029	1,060	1,090	1,118	1,149	1,182	1,211	1,243

The correction factors shown refer to water and glycol ethylene mixes used to prevent the formation of frost on the exchangers in the water circuit during inactivity in winter.

INTEGRATED HEATING CAPACITIES

Anternal exchanger inlet air temperature °C (D.B.)	-5 / -5.4	0 / -0.6	5 / 3.9	OTHERS
Heating capacity multiplication coefficient	0,89	0,88	0,94	1

To obtain the integrated heating capacities (the real heating capacity considering the defrost cycles too), multiply the kWt value in the heating performance tables by the following coefficient.

DIMENSIONS

Sizes 82-102-122

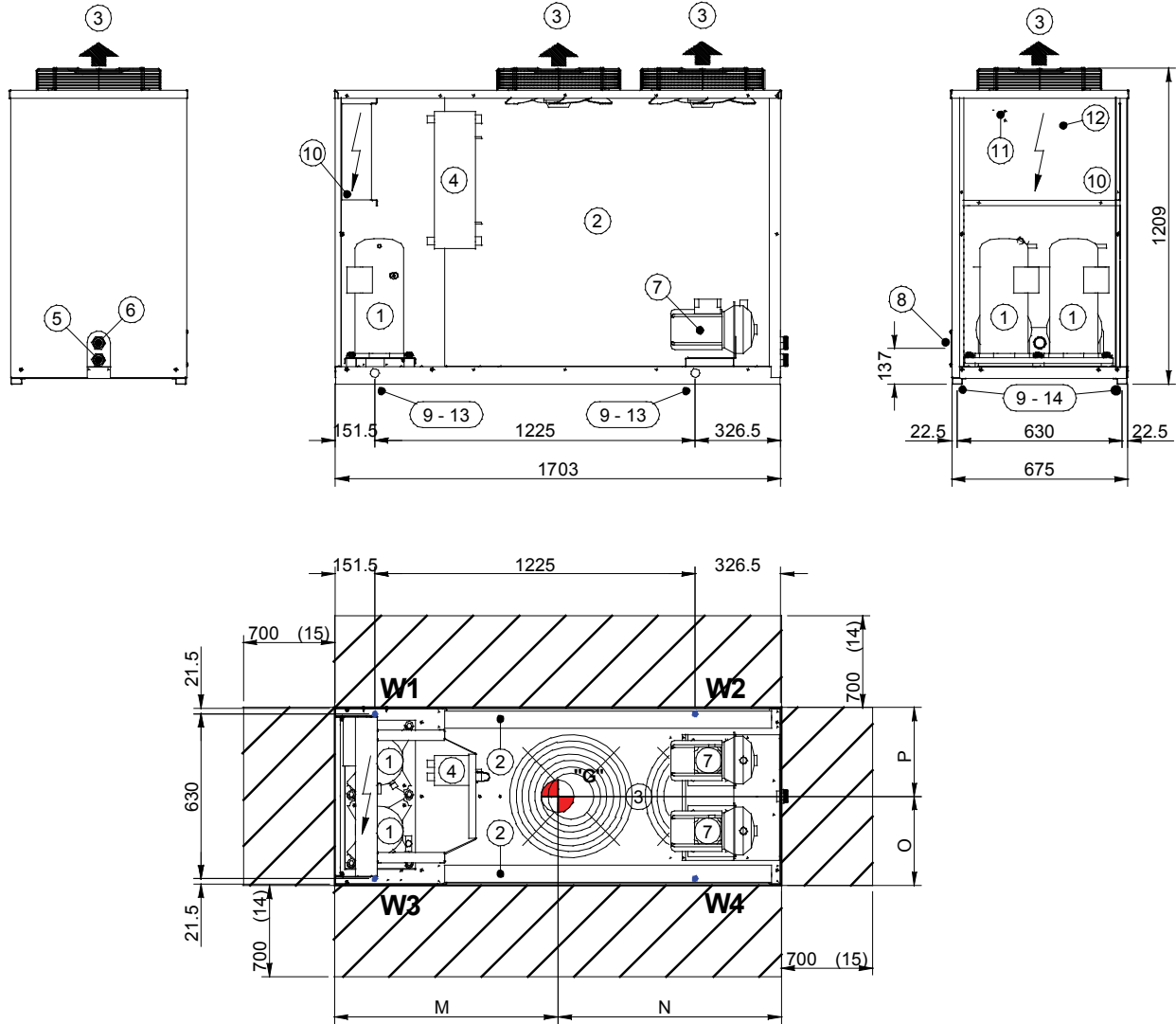

- (1) COMPRESSOR
- (2) FINNED EXCHANGER
- (3) HELICAL FANS
- (4) PLATE EXCHANGER
- (5) EXCHANGER WATER RETURN
- (6) EXCHANGER WATER SUPPLY
- (7) PUMP
- (8) POWER INPUT
- (9) LIFTING HOLES
- (10) ELECTRICAL PANEL
- (11) MICROPROCESSOR KEYBOARD
- (12) MAIN ISOLATOR SWITCH
- (13) VIBRATION MOUNTS POSITION
- (14) MINIMUM DIMENSION FOR A PROPER AIR FLOW TO THE CONDENSER COIL
- (15) MINIMUM DIMENSION FOR A SAFE PASSAGE
- (G) BARYCENTRE
- VICTAULIC CONNECTION JOINT

	Size	82	102	122
M	mm	705	700	699
N	mm	998	1003	1004
O	mm	345	345	345
P	mm	330	330	330
Length	mm	1703	1703	1703
Depth	mm	675	675	675
Height	mm	1209	1209	1209
W1	kg	98	99	115
W2	kg	58	59	68
W3	kg	85	87	101
W4	kg	64	65	76
Operating weight	kg	305	310	360
Shipping weight	kg	315	320	370

Sizes 162-182-222

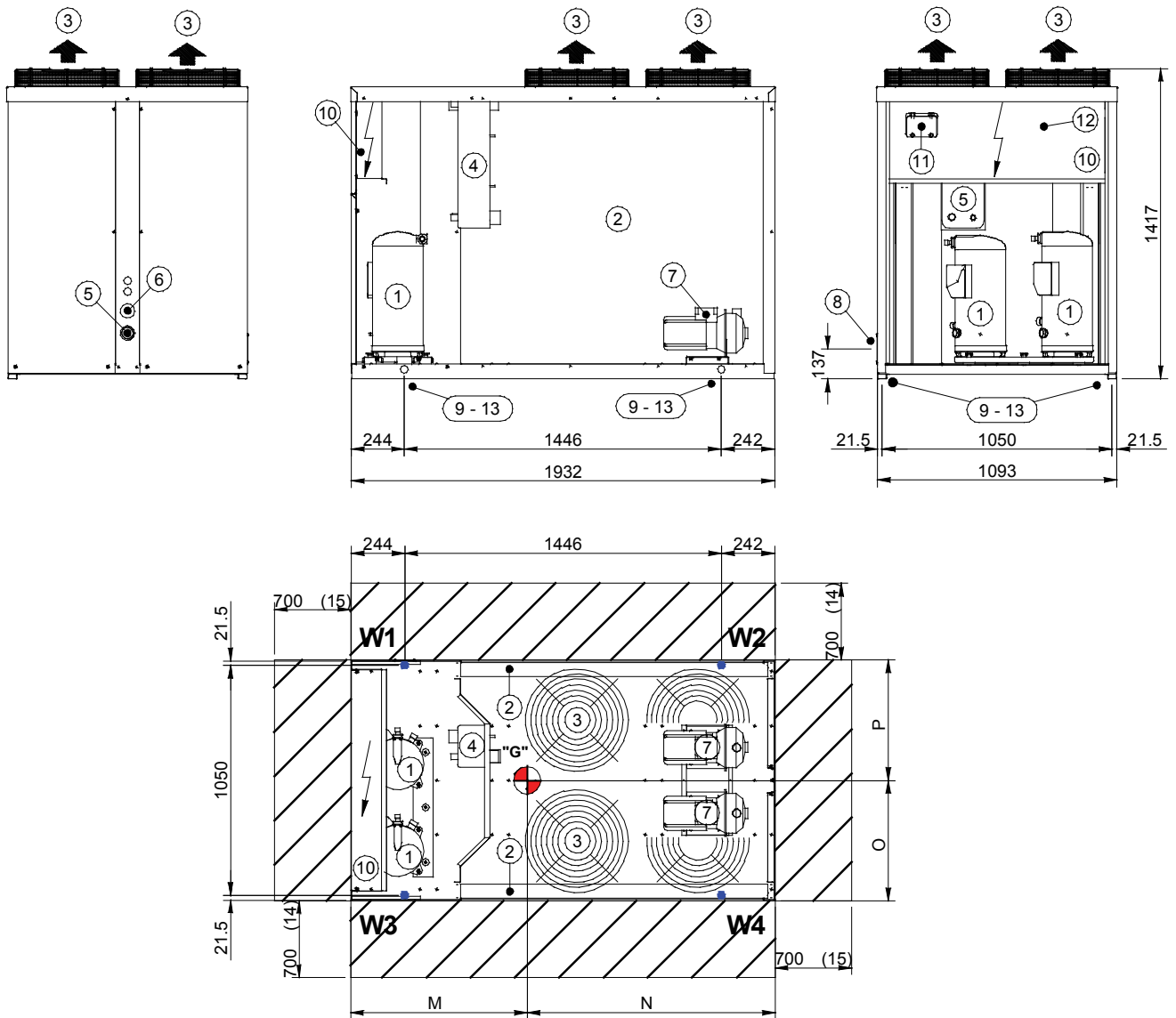

- (1) COMPRESSOR
- (2) FINNED EXCHANGER
- (3) HELICAL FANS
- (4) PLATE EXCHANGER
- (5) EXCHANGER WATER RETURN
- (6) EXCHANGER WATER SUPPLY
- (7) PUMP
- (8) POWER INPUT
- (9) LIFTING HOLES
- (10) ELECTRICAL PANEL
- (11) MICROPROCESSOR KEYBOARD
- (12) MAIN ISOLATOR SWITCH
- (13) VIBRATION MOUNTS POSITION
- (14) MINIMUM DIMENSION FOR A PROPER AIR FLOW TO THE CONDENSER COIL
- (15) MINIMUM DIMENSION FOR A SAFE PASSAGE
- (G) BARYCENTRE
- VICTAULIC CONNECTION JOINT

	Size	162	182	222
M	mm	892	888	889
N	mm	1040	1044	1043
O	mm	520	515	517
P	mm	580	585	583
Length	mm	1932	1932	1932
Depth	mm	1100	1100	1100
Height	mm	1417	1417	1417
W1	kg	166	173	182
W2	kg	99	103	108
W3	kg	146	151	160
W4	kg	109	113	120
Operating weight	kg	520	540	570
Shipping weight	kg	530	550	580

Sizes 262-302

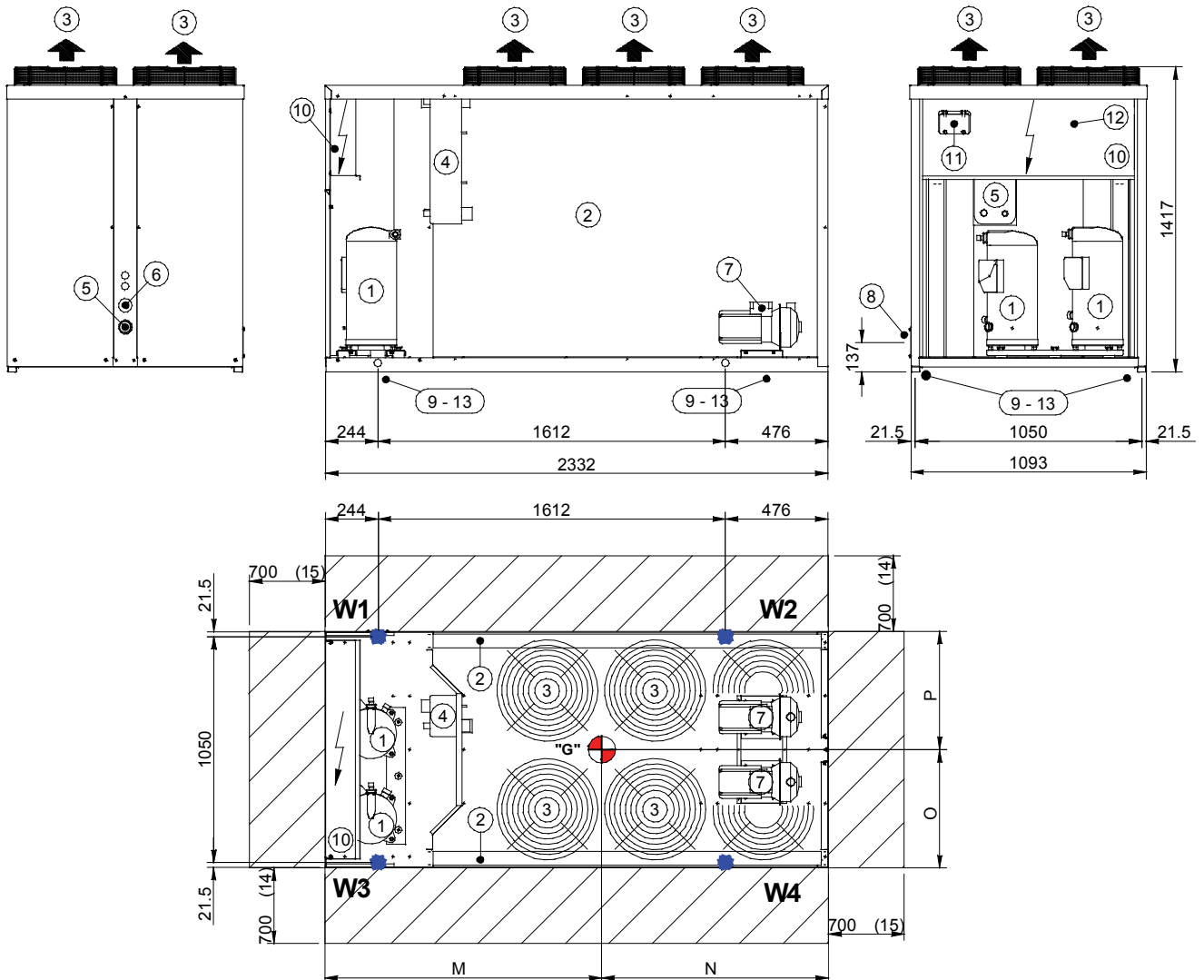

- (1) COMPRESSOR
- (2) FINNED EXCHANGER
- (3) HELICAL FANS
- (4) PLATE EXCHANGER
- (5) EXCHANGER WATER RETURN
- (6) EXCHANGER WATER SUPPLY
- (7) PUMP
- (8) POWER INPUT
- (9) LIFTING HOLES
- (10) ELECTRICAL PANEL
- (11) MICROPROCESSOR KEYBOARD
- (12) MAIN ISOLATOR SWITCH
- (13) VIBRATION MOUNTS POSITION
- (14) MINIMUM DIMENSION FOR A PROPER AIR FLOW TO THE CONDENSER COIL
- (15) MINIMUM DIMENSION FOR A SAFE PASSAGE.
- (G) BARYCENTRE
- VICTAULIC CONNECTION JOINT

	Size	262	302
M	mm	1105	1100
N	mm	1227	1232
O	mm	515	513
P	mm	585	587
Length	mm	2332	2332
Depth	mm	1100	1100
Height	mm	1417	1417
W1	kg	166	173
W2	kg	99	103
W3	kg	146	151
W4	kg	109	113
Operating weight	kg	520	540
Shipping weight	kg	530	550

CLIVET SPA
Feltre (BL) ITALY
Tel. + 39 0439 3131
Fax + 39 0439 313300
info@clivet.it

CLIVET ESPAÑA S.A.
Madrid - SPAIN
Tel. + 34 91 6658280
Fax + 34 91 6657806
info@clivet.es

CLIVET UK LTD
Fareham (Hampshire) U.K.
Tel. + 44 (0) 1489 572238
Fax + 44 (0) 1489 573033
info@clivet-uk.co.uk

CLIVET NEDERLAND B.V.
Amersfoort - Netherlands
Tel. + 31 (0) 33 7503420
Fax + 31 (0) 33 7503424
info@clivet.nl

CLIVET SPA
BUREAU DE LIAISON EN FRANCE
Verrières le Buisson - FRANCE
Tel. + 33 (0)1 69 20 25 75
Fax + 33 (0)1 69 20 60 76
info.fr@clivet.com

CLIVET GmbH
Norderstedt - GERMANY
Tel. +49 (0) 40 32 59 57-0
Fax +49 (0) 40 32 59 57-194
info.de@clivet.com

CLIVET TFAIR SYSTEMS (P) LTD.
Malur - INDIA
Tel. +91 8151 232683/5
Fax +91-8151-232684
info@clivetffa.com

The data contained in this bulletin is not binding and may be changed by the manufacturer without prior notice. All reproduction, even partial, is PROHIBITED.

© COPYRIGHT - CLIVET S.P.A. - FELTRE (BL) - ITALIA